

DRYWALL

One 5 gallon ready mix joint compound will be required for every thousand square feet of drywall.

Tapered edge allows space for tape and joint treatment to be applied so completed job will be flat.

TYPE	DESCRIPTION	SHEET	1/4"	3/8"	1/2"	5/8"
Regular Gypsum Board	Gypsum Board is faced with a cream paper which will accommodate virtually any decorative treatment. A gray paper is used on the backside of the board. The 1/2" and 5/8" thick tapered board is recommended for single layer application in new construction.	4' x 8'	14DW	38DW	12DW	
		4' x 10'			12DW10	
Fire Rated Gypsum Board	When used on both sides of a load-bearing wood stud partition, 5/8" Type X gypsum board has a 1-hour fire rating while 1/2" Type X will provide a 45-minute rating.	4' x 8'			12FRDW	58FRDW
		4' x 10'			12FRDW10	58FRDW10
		4' x 12'				58FRDW12
Water-Resistant Gypsum Board	This gypsum board product, identified by a green face paper, has a water-resistant core intended for use as a backing for ceramic, plastic or metal tile in tub, bathroom, or shower areas. "GREEN BOARD"	4' x 8'			12WRDW	58WRDW
Exterior Gypsum	FOR EXTERIOR USE FIRE-SHIELD JUMBO GYPSUM SHEATHING. To be used as sheathing for fire rated exterior wall construction, type X core. 5/8" ANSI C-79	4' x 8'				58EXDW

INTERIOR TILE BACKER BOARD

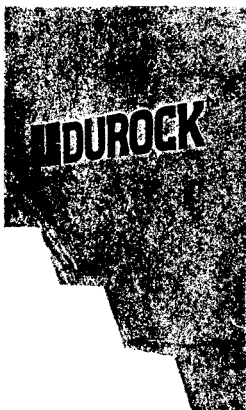

Durock Interior Tile Backer Board possesses excellent flexural and compressive strength, hardness and impact resistance as a tile base. The board surface provides high shear bond strength with latex fortified mortar and Type I water-resistant organic adhesives.

Durock Interior Tile Backer Board provides a smooth, sound base for glass and ceramic mosaics; ceramic and quarry tile; lugged tile; thin stone and brick. Suitable for application to wood or steel framing spaced 16" o.c. in new construction and in remodeling. Board is ideal for use in interior partitions, walls, floors, ceilings in wet or dry areas. It is highly efficient in high-moisture areas found in baths, showers, kitchens and laundry rooms.

SKU NO.	SIZE
12 DURO	1/2" x 3' x 5'
107600	1/2" x 3' x 5' "UNIPAN"

HARDI BACKER BOARD

1/4" x 3' x 5'

Lightweight, Versatile,
 Permanent, Water Resistant
 Backer Board for use on
 Floors, Walls, Countertops
 and Ceilings

SKU
14HARDI 1/4" x 3' x 5'



**UNIMAST
 INCORPORATED**

Studs and Runners for non-load bearing curtain wall systems or interior assemblies of greater-than-normal height, and as special reinforcement for door frames. These studs and runners meet ASTM A568 for uncoated steel thickness, and are supplied with a corrosion-resistant coating of: G40 hot-dip galvanizing, meeting ASTM A525;

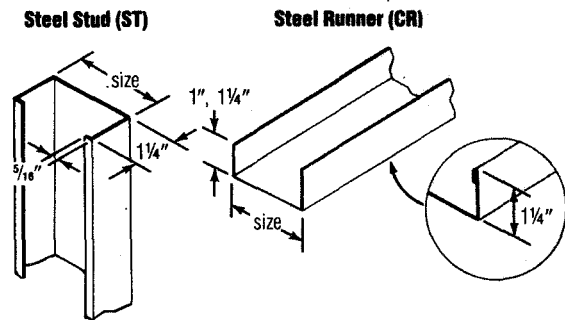

METAL STUDS

SKU NO.	MFG. NO.	GAUGE	SIZE
15808MS	158CR25	25	1 5/8" x 8'
15809MS	158CR25	25	1 5/8" x 9'
15810MS	158CR25	25	1 5/8" x 10'
15812MS	158CR25	25	1 5/8" x 12'
21208MS	212CR25	25	2 1/2" x 8'
21209MS	212CR25	25	2 1/2" x 9'
21210MS	212CR25	25	2 1/2" x 10'
21212MS	212CR25	25	2 5/8" x 12'
35808MS	358CR25	25	3 5/8" x 8'
35809MS	358CR25	25	3 5/8" x 9'
35810MS	358CR25	25	3 5/8" x 10'
35812MS	358CR25	25	3 5/8" x 12'
35814MS	358CR25	25	3 5/8" x 14'
35816MS	358CR25	25	3 5/8" x 16'
35818MS	358CR25	25	3 5/8" x 18'
35808MS20	358ST20	20	3 5/8" x 8'
35810MS20	358ST20	20	3 5/8" x 10'
35812MS20	358ST20	20	3 5/8" x 12'
610MS20	600ST20	20	6" x 10'
612MS20	600ST20	20	6" x 12'

METAL TRACK

SKU NO.	MFG. NO.	GAUGE	SIZE
15810MT	158CR25	25	1 5/8" x 10'
21210MT	212CR25	25	2 1/2" x 10'
35810MT	358CR25	25	3 5/8" x 10'
35810MT20	358GR20	20	3 5/8" x 10'
610MT20	600CR20	20	6" x 10'

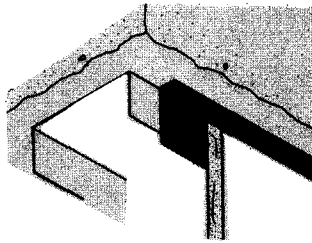
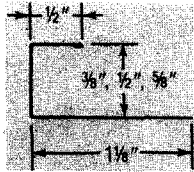

For Drywall

SHEETROCK Metal Trim No. 400, 401 and 402 are reveal-type, galvanized steel trims used for door or window openings. Also provides a clean trim line at intersections or where gypsum panels abut dissimilar surfaces such as columns and window mullions. No finishing with joint compound is required with these trims.

SKU NO.	MFG. NO.	SIZE
102095	400	3/8" x 8'
102100	400	3/8" x 10'
102105	401	1/2" x 8'
102110	401	1/2" x 10'
102115	402	5/8" x 8'
102120	402	5/8" x 10'

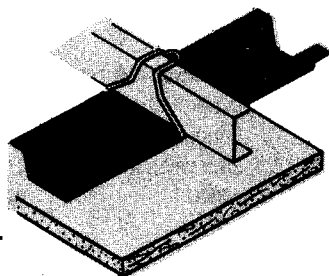
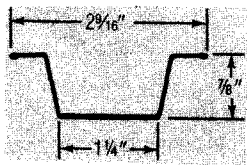

For Drywall and Plaster

Unimast Metal Furring Channel is a roll-formed, hat-shaped section available in two gauges of galvanized steel. The DWC-25 channel is for attachment of SHEETROCK brand Gypsum Panels, IMPERIAL Gypsum Base or ROCKLATH Plaster Base in ceiling construction. Also provides noncombustible furring for interior or exterior walls.

Drywall Furring Channel Clip

SKU NO.	SIZE	SKU NO.
7812FC	7/8" x 12'	115775

(Veneer Screen Bead)

SHEETROCK Corner Bead No. 900 is galvanized steel, used with two-coat veneer systems to provide 3/32" grounds. With 1/4" fine-mesh flanges either stapled or nailed, it provides effective plaster key and eliminates shadowing.

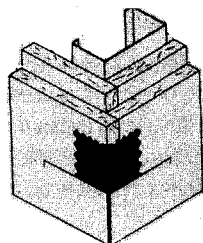
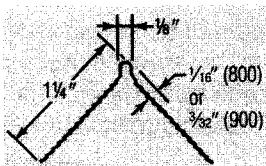

SKU NO.	SIZE
102205	1 1/4" x 1 1/4" x 10'
102200	1 1/4" x 1 1/4" x 8'

ROLLED EDGE WIND BRACING

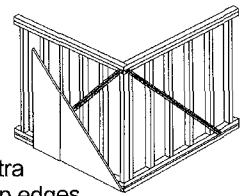
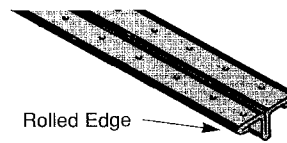

Roller edge gives this T-style bracing extra strength and rigidity and eliminating sharp edges.

SKU NO.	DIMENSIONS
803575	11' 3"
803578	9' 3"

BEAD X

Metal outside corner with cloth tape attached to achieve smooth blend of taping compounds with minimum of effort

SKU NO.	LENGTH
102048	8'

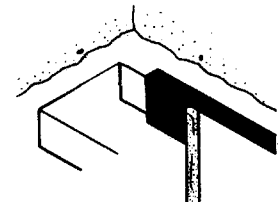
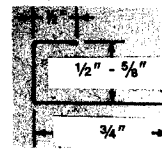

For Drywall

TrimTex Plastic Trim are reveal-type, plastic trims used for door or window openings. Also provides a clean trim line at intersections or where gypsum panels abut dissimilar surfaces such as columns and window mullions. No finishing with joint compound is required with these trims.

SKU NO.	SIZE	DESCRIPTION
102065	1/2" x 8'	J Bead
102170	1/2" x 10'	J Bead
102175	5/8" x 8'	J Bead
102180	5/8" x 10'	J Bead
102181	10'	Archway Cornerbead
102189	8'	Archway Cornerbead
102186	3/4" x 8'	Bullnose Cornerbead
102208	5/8" x 10'	Pull-Away L Bead
102183	1 1/2" x 1 1/2" x 10'	Clip-on Outside Corner
102163	1 1/2" x 1 1/2" x 10"	PVC Angle

For Drywall and Veneer Plaster Finishes

SHEETROCK Zinc Control Joint No. 093 is used to relieve stresses of expansion and contraction across the joint in large ceiling and wall areas in drywall and veneer finish systems. Used from floor to ceiling in long partition runs and from door header to ceiling. Also recommended for repair of existing plastered masonry. Made of roll-formed zinc to resist corrosion, has 3/32" grounds. Plastic tape protects 1/4" opening 7/16" deep, removed after installation. *Limitation:* where sound transmission and/or fire ratings are prime considerations, an adequate seal must be provided behind control joint.



EXPANSION STRIP

SKU NO.	MFG.
102088	093



**UNIMAST
 INCORPORATED**

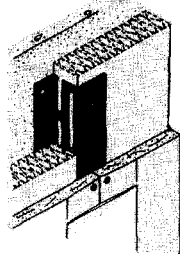
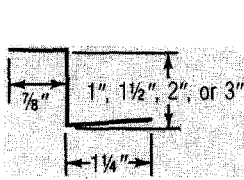

For Drywall and Plaster

SHEETROCK Z-Furring Channel, made of galvanized steel, is used to attach rigid foam insulation and other types of insulation,

SKU NO.	SIZE
102081	1 1/2" x 10'
102084	1 1/2" x 8'6"
102086	1" x 8'6"

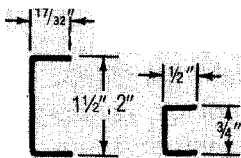

For Drywall and Plaster

Unimast Cold-Rolled Channel, of 16-ga. steel, is used to laterally brace studs and for furring walls and ceilings; also for suspended ceilings, partition construction and ornamental lathing.

SKU NO.	SIZE
808273	1/2" x 3/4" x 16'
808276	1/2" x 1 1/2" x 16'

For Drywall

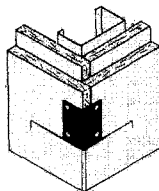
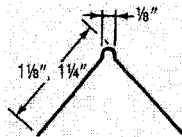

DUR-A-BEAD Corner Bead, part of the family of SHEETROCK metal products. It is an all-metal, galvanized steel reinforcement for protecting external corners. Panels. It is nailed, stapled or clinched on to framing through the panels. With bonding compound provides additional protection against delamination of joint compound from steel.

SKU	Mfg. No	Size
102093	114-12'	1 1/4" x 1 1/4" x 12'
102090	114-10'	1 1/4" x 1 1/4" x 10'
102085	114- 8'	1 1/4" x 1 1/4" x 8'

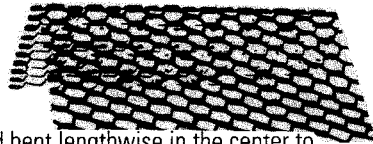

Cornerite is selvaged and bent lengthwise in the center to form a 100° angle, to be used: in all internal plaster angles where metal lath is not carried around, over non-ferrous lath and anchored to the lath, over internal angles of masonry construction, in the "floating angle" method of applying gypsum lath to wood framing in order to reduce plaster cracking.

SKU NO.	SIZE	GALVANIZED
102185	3" x 3" x 8'	

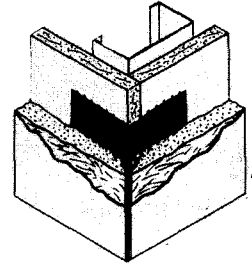
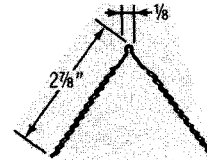

For Plaster

Unimast 1-A Expanded Corner Bead is available in zinc or galvanized steel, has wide expanded flanges that are easily flexed. Preferred for irregular corners. Provides increased reinforcement close to nose of bead. Zinc must be used for exterior applications.

SKU NO.	MFG. NO.	SIZE
102195	1A-10'	10'
102190	1A-8'	8'

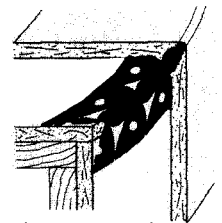
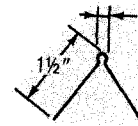

For Plaster

Unimast 4-A Flexible Corner Bead is an economical general-purpose galvanized steel corner bead. By snipping flanges, this bead may be bent to any curved design (for archways, telephone niches, etc.).

SKU NO.	MFG. NO.	SIZE
102197	4A-10	1 1/2" x 10'

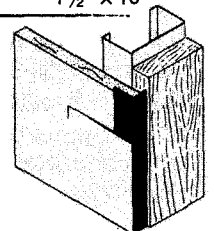
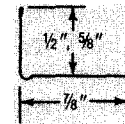

For Drywall

SHEETROCK Metal Trim No. 200-B is galvanized steel, and has an L-shaped edge trim. Elimination of back flange simplifies installation. For use with 1/2" and 5/8" panels. Installation is completed by application of joint compound.

SKU NO.	MFG. NO.	SIZE
102125	200B	1/2" x 8'
102130	200B	1/2" x 10'
102135	200B	5/8" x 8'
102140	200B	5/8" x 10'

For Drywall and Plaster

Unimast Metal Angle is made of 24-ga. galvanized steel. The 7/8" x 7/8" size is used to secure 1" coreboard at floor and ceiling in laminated gypsum drywall partitions and in single- and double-solid IMPERIAL Plaster Partitions. Angles in other sizes and gauges available on request.

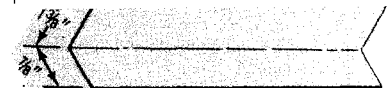

SKU NO.	TYPE	SIZE
102097	24GA	7/8" x 7/8" x 10'
102099	20GA	1 1/2" x 1 1/2" x 10'

DRYWALL JOINT TAPE

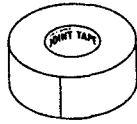

PERF-A-TAPE Reinforcing Tape is strong, cross-fibered paper tape with minimal longitudinal stretch and superior tensile strength. Lightly precreased for corner application. For estimating purposes: for 1,000 sq. ft. of surface area to be finished, approximately 370 lin. ft. of tape and 83 lb. of powder-type, 138 lb. of ready-mixed type or 90 lb. of PLUS 3 Total Joint Compound are required.

SKU NO.	MFG. NO.	WIDTH	LENGTH
102052		2 1/16"	75
102055	746891	2 1/16"	250
102060	746909	2 1/16"	500

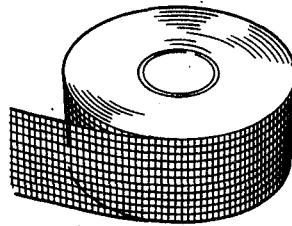

Self Adhesive Fiberglass Drywall Joint Tape. For use taping and patching drywall material. Strong fiberglass mesh reinforcement. Adhesive eliminates need for pre-plastering. Flexible, will not blister or bubble. Faster and easier to apply than conventional paper tape. Boxed.

SKU — 455318
No. 09062 Fiberglass Joint Tape.
 2" x 50' Roll.

SKU — 455321
No. 09063 Fiberglass Joint Tape.
 2" x 100' Roll.

SKU — 455324
No. 09064 Fiberglass Joint Tape.
 2" x 150' Roll.

SKU — 455327
No. 09065 Fiberglass Joint Tape.
 2" x 300' Roll.

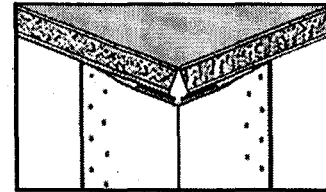
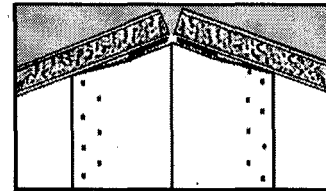

MULTIFLEX DRYWALL TAPE
 DRYWALL TAPE WITH METAL REINFORCED STRIPS FOR ODD ANGLE CORNERS

SKU NO 102047
ROLL SIZE 2" X 100 FT

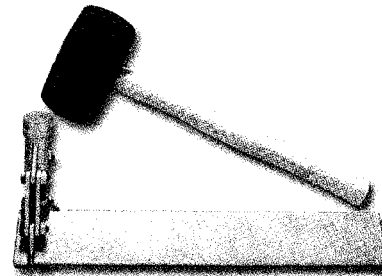

DRYWALL CORNER-BEAD TOOL
 DRYWALL CORNER-BEAD TOOL WITH Mallet. USED TO CRIMP FASTEN METAL DRYWALL CORNER BEAD TO DRYWALL WITHOUT FASTENERS.

SKU NUMBER
 704518

MANUFACTURER NO
 GB-15-810



JOINT COMPOUND - FIRECODE

For USG Fire Stop Systems. Durable Fire Stop, use with Thermafiber Fire Safing Insulation to form a very tough, durable fire stop. Economical to use. Mix only the amount you need so waste is eliminated., **SETTING TIME:** Once applied, compound hardens in approximately 23 hours. **REMOVABLE:** May be removed in case of retrofit work. **EASILY IDENTIFIABLE:** Dries to a pale red color. **PAINABLE:** Once dry, compound may be sanded smooth and painted with latex or oil paint.

SKU 102030
SIZE 15 Pounds

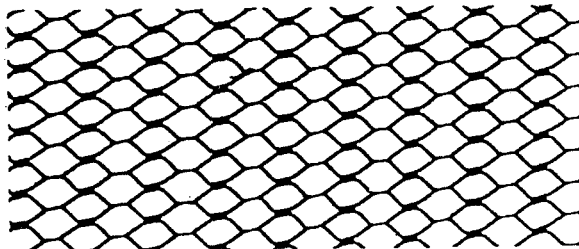

USG Junior Diamond Mesh Lath is a small diamond mesh metal plaster base (approx. 11,000 meshes per sq. yd.), a general all-purpose lath, best for ornamental, contour plastering. The small meshes conserve plaster and reduce droppings.

GALVANIZED METAL LATH

300085 2' x 8' 16

Durabond

United States Gypsum Company

Easy Sand

SHEETROCK Setting-Type Joint Compound (DURABOND®) Features exceptional bond; virtually unaffected by humidity extremes. Ideal for laminating double-layer systems, particularly fire-rated assemblies, and for adhering gypsum panels to above-grade concrete surfaces. Offers choice of setting times: 20, 45, 90,

SHEETROCK Setting-type Powder Joint Compounds

SKU NO.	Product	Set. Time	Approx. Work. Time	Approx. Coverage	Packaging
DURABOND					
102017	D-20	20-30 min.	15 min.	72 lb./1000 ft. ²	25 lb. bag
102020	D-45	30-80	20	72 lb./1000 ft. ²	25 lb. bag
102015	D-90	85-130	60	72 lb./1000 ft. ²	25 lb. bag

SHEETROCK Lightweight Setting Type Joint Compound (EASY SAND™), unlike conventional setting-type compounds, provides sanding ease similar to a ready-mixed, all purpose joint compound. Weighs 25% less than conventional setting-type compounds for easy handling, faster application and improved productivity on the job. Offers choice of setting times: 20, 45, 90.

EASY SAND (Lightweight Setting-Type)

SKU NO.	Product	Set. Time	Approx. Work. Time	Approx. Coverage	Packaging
102022	LD-20	20-30 min.	15 min.	52 lb./1000 ft. ²	18 lb. bag
102024	LD-45	30-80	20	52 lb./1000 ft. ²	18 lb. bag
102026	LD-90	85-130	60	52 lb./1000 ft. ²	18 lb. bag
102000	"EASY SAND 5"	-	-	-	4 lb. bag

SHEETROCK™ Powder Joint Compounds are top-quality, non-asbestos, conventional powder products providing easy mixing, smooth application and ample working time. Available in Taping, Topping and All Purpose formulations.

SHEETROCK Drying-Type Powder Joint Compounds

SKU NO.	Product	Approx. Coverage	Packaging
102010	Topping	83 lb./1000 ft. ²	25 lb. bag
102005	All Purpose	83 lb./1000 ft. ²	25 lb. bag
102030	Fire Stop Joint Compound		15 lb. bag

SHEETROCK Lightweight All Purpose Joint Compound (PLUS 3™) offers all the benefits of a conventional all purpose product plus some exclusive advantages. It weighs up to 35% less than conventional compounds to make handling and application easier and faster. Due to its very low shrinkage, only two coats rather than three are needed over metal, such as corner bead and fasteners. Plus it sands easier than any other compound.

PLUS 3 (Lightweight All Purpose)

SKU NO.	Product	Approx. Coverage	Packaging
102036		9.4 gal./1000 ft. ²	1.0 Gal
102038		9.4 gal./1000 ft. ²	4.5 Gal Pail
102063	Pigmented Plus 3		42 lb. Box

SHEETROCK All Purpose Joint Compound is used for embedding, finishing, simple texturing, laminating and skim coating. Combines single package convenience with good taping and topping characteristics. Also recommended for repairing cracks and small holes in interior plaster and masonry not subject to moisture.

SHEETROCK Topping Joint Compound is a low-shrinkage, easily applied and sanded product recommended for second and third coats over taping and all purpose compounds.

SHEETROCK Ready-Mixed Joint Compounds

SKU NO.	Product	Approx. Coverage	Packaging
102045	Topping	138 lb./1000 ft. ²	61.7 lb. pail;
102040	All Purpose	138 lb./1000 ft. ²	61.7 lb. pail;
102043	All Purpose		60 lb. box



NOVA CORK

Cork covered paneling

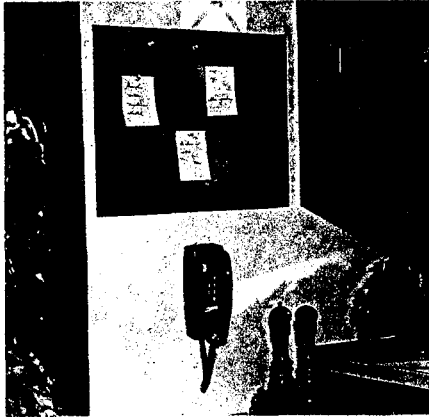

Bulletin Boards (Cork Board) Non Framed

PRODUCT DESCRIPTION

Nova Cork is a factory prefinished interior paneling composed of natural virgin cork laminated to both sides of Homasote fiberboard.

USES, APPLICATIONS

Nova Cork panels are prefinished, tackable, wall panels. They are used in homes, schools, offices, or any application where a decorative, tackable wall is required. Nova Cork panels are available in 4' x 8' and smaller cut to size dimensions (see chart below). The 4' x 8' panels carry a Class B Fire Rating and are also available in Class A. Cut to size panels are Class B Fire Rated only.

ADVANTAGES

Nova Cork panels have the versatility to be an attractive finished wall panel and provide a fully tackable surface that conceals tacks and pinholes.

SIZE	18" x 24"	24" x 36"	35" x 48"	48" x 96"
SKU	1824 COR	2436 COR	3648 COR	4896 COR

*All boards are 1/2" thick

CHALK BOARDS & BULLETIN BOARDS

Chalk Boards - Framed

SIZE	24" x 36"	35" x 48"
SKU NO.	104018	104020

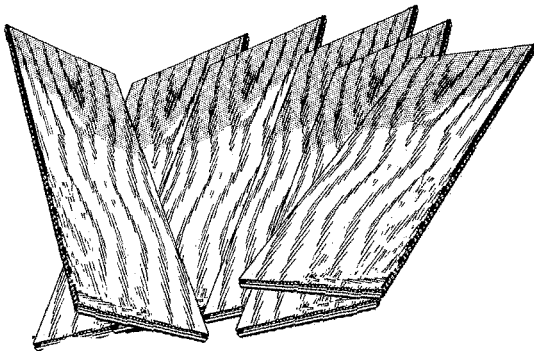

INTERIOR WALL COVERING PANELING

All paneling is 4' x 8'

SKU	DESCRIPTION	Size	Type
101185	HAZELNUT	1/4"	HARD BOARD
101205	TIMBER RIDGE OAK	7/16"	REAL WOOD
101208	BRIGHTON OAK	1/4"	REAL WOOD
101242	MOONLIGHT	1/8"	REAL WOOD
101245	NEW CUT CEDAR	1/4"	PARTICLE BOARD
101246	AUTUMN OAK	5/32"	PARTICLE BOARD
101248	LIGHT OAK BEADED	1/4"	REAL WOOD
101249	UNFINISHED OAK	1/4"	REAL WOOD
101252	BRICKE BLANCO	1/4"	HARDBOARD
103481	WHITE POLY WALL	.06"	PLASTIC
14WP	WHITE PEG BOARD	1/4"	HARDBOARD
18MIR	WHITE BATH PANEL	1/4"	HARDBOARD

EXTERIOR WALL COVERING T1-11

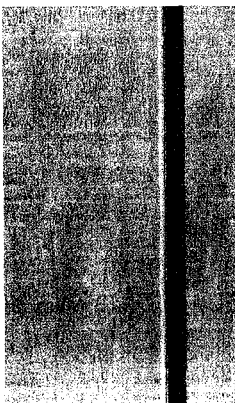

APA TEXTURE 1-11

Special Rated Siding 303 panel with shiplapped edges and parallel grooves 1/4" deep, 3/8" wide; grooves 4" or 8" oc are standard. Other spacings may be available on special order. T1-11 is available only in 19/32" and 5/8" thicknesses. Rough-sanded panel shown above. Also available with scratch-sanded, overlaid, brushed and other surfaces. Available in Douglas-fir, cedar, redwood, southern pine and other species.

SKU	SIZE
56T111	8"OC-6P 5/8" T1-11 SYP 4' X 8' SIDING

GENERAL PURPOSE

Product Description

General Purpose laminates are manufactured by pressing core papers impregnated with phenolic resins, a decorative sheet, and an overlay sheet impregnated with melamine resins at 1200 psi at 325°. The back is sanded to provide uniform thickness and to facilitate bonding.

Basic Uses

General Purpose Grade laminates are designed for both horizontal and vertical applications and is suited to a wide variety of uses. These include counters, table tops, vanities, interior doors, cabinets, as well as retail store fixtures, contract furniture, reception areas and pedestals. Vertical grade is identical in manufacture except for its thickness, and is designed expressly for verticle applications such as wall panels, interior doors, bath enclosures, toilet partitions, elevator cab interiors and other vertical end uses.

Installation

Decorative laminates should be bonded to a suitable substrate, such as good quality plywood, medium to high density fiberboard particle board and metals. Use adhesives and techniques as recommended by the manufacturer, DLPA Spec. No. Q51-1008, and NEMA LD3.1-1991.

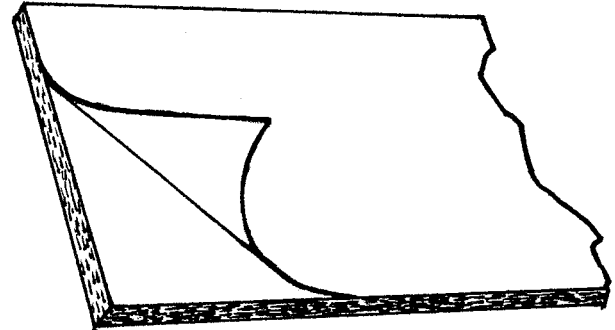

LAMINATES

- ① Wilsonart
- ② Formica
- ③ Pionite
- ④ Nevamar

SPECIAL ORDER WIDTHS

24", 30", 36", 48", 60"

LENGTHS

72", 96", 120", 144"

NOTE: Special order laminates are available in 1 to 2 working days.

STOCK WILSON ART

Laminates 48" x 96" only

SKU NO.	COLOR
105001	Dove Grey
105003	Almond
105005	Designer White
105010	Black
105020	Golden Oak
105023	Shadow Blue

Kampel SEAMFIL
 The Original Laminate Repair

SeamFil is a hard-curing liquid plastic used to repair nicks, gouges and fill seams in plastic laminates. Perfectly matched to all major laminate colors, SeamFil will enhance the appearance of any installation. Packaged in 1 oz. tubes, SeamFil can be mixed on the job, or ordered to match any color exactly.

SKU NO.	PART NO.	DESCRIPTION	SIZE
105025	3-89-08-099	SF-99 SeamFil Solvent	1/2 pint
105030	3-89-00-901	901 SeamFil White	1-oz tube
105035	3-89-00-902	902 SeamFil Lt. Grey	1-oz tube
105040	3-89-00-904	904 SeamFil Tan	1-oz tube
105045	3-89-00-913	913 SeamFil Brown	1-oz tube
105050	3-89-00-914	914 SeamFil Black	1-oz tube
105055	3-89-00-933	933 SeamFil Teak	1-oz tube
105060	3-89-00-936	936 SeamFil Prm Yellow	1-oz tube
105065	3-89-00-937	937 SeamFil Prm Red	1-oz tube
105070	3-89-00-940	940 SeamFil Orange	1-oz tube
105075	3-89-00-941	941 SeamFil Almond	1-oz tube
105085	3-89-00-944	944 SeamFil Retard	1-oz tube
105090	3-89-00-945	945 SeamFil Spec Grey	1-oz tube
105095	3-89-00-946	946 SeamFil Spec Blue	1-oz tube
105099		SeamFil Kit-Standard	



EDGE SQUEEZE ROLLER

This lever action roller puts pressure on the laminate at the edges to seal them down tight to the substrate. Very useful for correction the occasional edge-lift problem, and handy for pressing edge strips on tightly. The tip roller rides on the underside and the mid-roller rides on the upper-side to put handle pressure on the edge. Non-marking plastic rollers. 12" OAL. (SR-79).

SKU NO. 700008

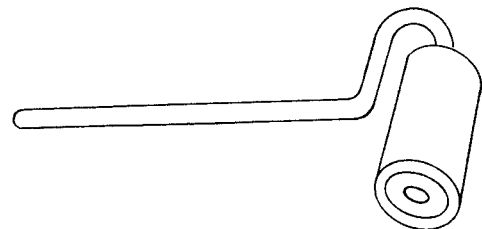

No. J-200 JAY ROLLER

Designed specially for plastic laminate work. Gives 20-25 lbs. pressure per inch. 3" wide solid non-marking rubber roller has no axle projections on one side, permitting rolling flush to walls without marring them. This is a really important feature. Lightweight aluminum handle is 14" long. Recommended by a leading plastic laminate manufacturer.

SKU NO. 455343

 Chicago Metallic Corporation

300 SYSTEM

The 300 System is the convenient and economical way to lower high ceilings, or cover exposed joists, ductwork or damaged plaster, distinctively. Rooms become quieter, brighter and more elegant.

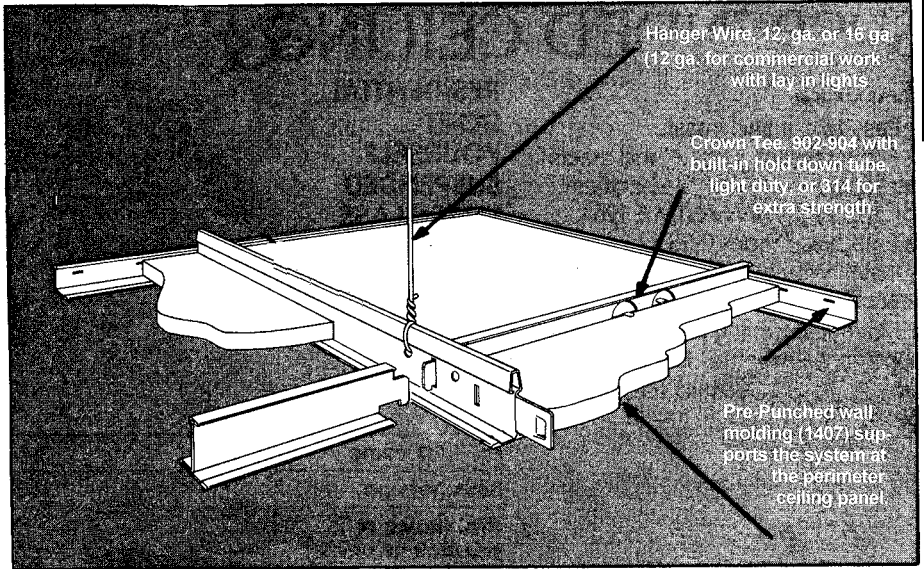

COMPONENT TYPE	Mfg. No.	White - 01
12' Main Runner	300	102210
2' Cross Tee	302	102225
4' Cross Tee	304	102220
10' Wall Angle	1407	102215

FIRE FRONT™ 240 SYSTEM

The Fire Front™ 240 System is America's number one fire-rated ceiling system

In a fire situation, the elongation of components (due to heat) is compensated for by built-in expansion sections which do not interfere with the system's assembly, performance or appearance. The components maintain their position, holding fire-rated acoustical panels in place, and thereby protect the building's structure.

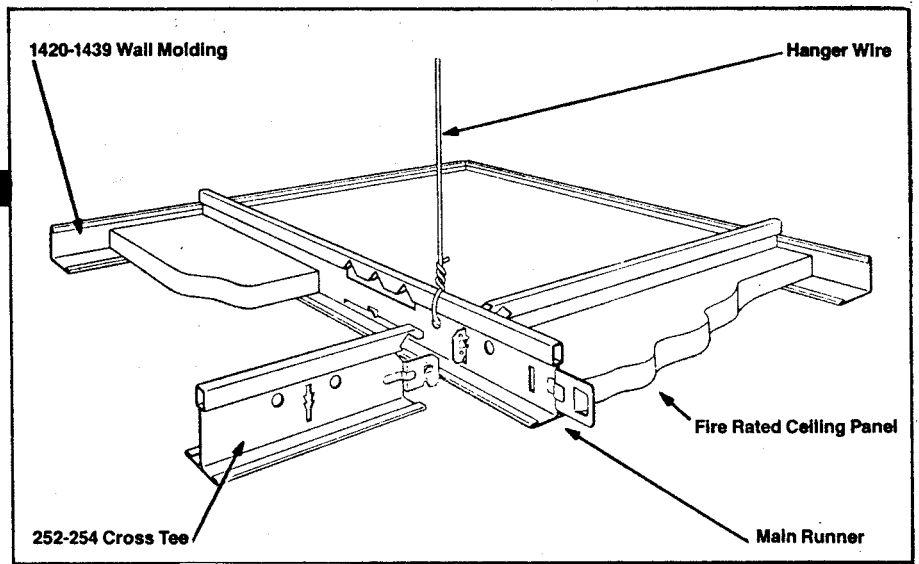

COMPONENT TYPE	Mfg. No.	White - 01
12' Main Runner	250	102270
2' Cross Tee	252	102290
4' Cross Tee	254	102285
12' Wall Angle	1420	102275

SUSPENDED CEILING ACCESSORIES

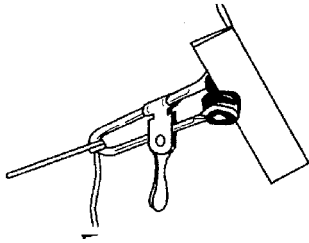

Ceiling Grid Clamps
 #5030
SKU 802533

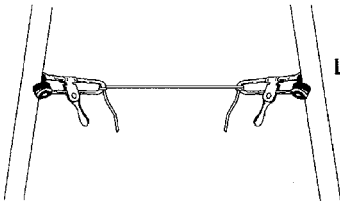

Leveling Line
 #5005
SKU 802539

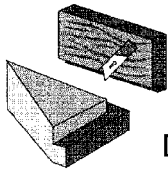

Reveal Edge Cutter
SKU 802542
 [Replacement Blades 802569]



ACCESS CLIPS
 SKU 102315

125

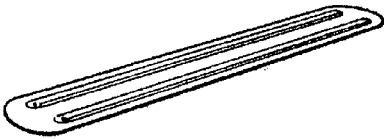

Spline
SKU 102330
 Mfg. No. 57

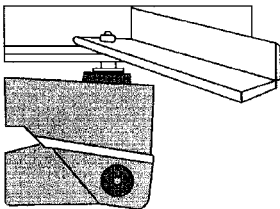

Mfg. No. Rivets, Black #5110 **SKU 802560**
 Mfg. No. Rivets, White #5111 **SKU 802563**

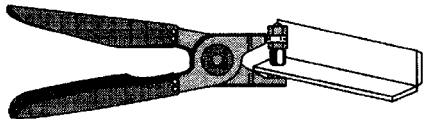

#5001 Piercing Tool
SKU 802527

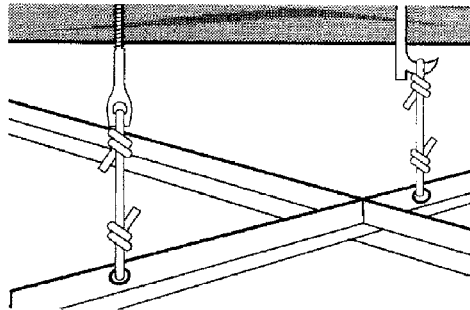

HANGER WIRE

SKU	Mfg. No.	Size
802530	#5010	100'
102335		12'
102345	(15 pak)	4'

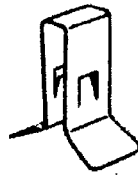

Hold Down Clip
SKU 802542
 Mfg. No. 820

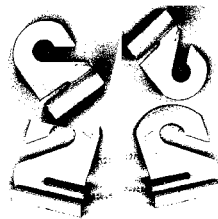

Barnacle Clips
SKU 102324 - 10pr
102327 - 2pr

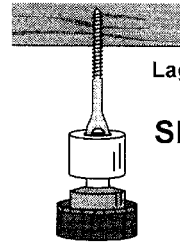

Lag Screw Driver
 #5050
SKU 802536

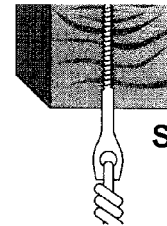

Lag Screws
 #5051
SKU 802545

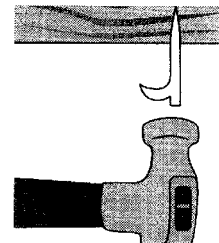

Tie Wire Nails
 #5115
SKU 802554

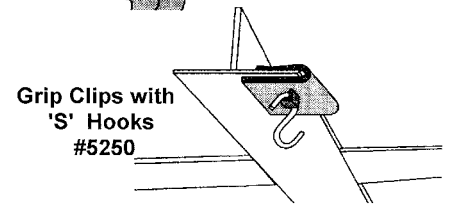

Grip Clips with
 'S' Hooks
 #5250

SKU 802548

CEILING TILE INSTALLATION KIT 802566

SUSPENDED CEILING PANELS



FEATURES

- Easy to cut and install.
- Fire-retardant; Class A and meets requirements of Federal Specifications SS-S-118B and ASTM E 1264. Flame Spread Index 0-25.
- Install with only 2" of overhead clearance.
- Fiberglass ceiling panels are vinyl-faced and washable. Just use a damp sponge and mild soap solution.

RESIDENTIAL/DO-IT-YOURSELF SUSPENDED FIBERGLASS PANELS

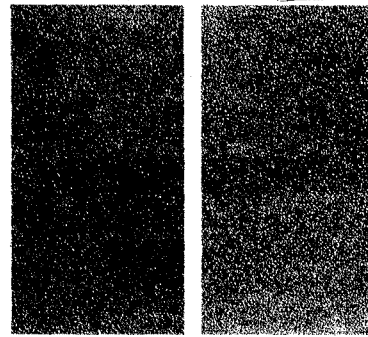

Product name	Esprit	Random Fissured
Item no.	403	2910
NRC (noise reduction coefficient range)	50%-60%	.70
Size	2'x4'x5/8"	2' x 4' x 5/8"
Sq. ft. per carton	80	128
SKU NOS.	101785	101812

FEATURES

- Washable with mild soap solution (except Rockcastle)
- Fire-retardant; Class A and meets requirements of Federal Specifications SS-S-118B and ASTM E 1264
- Require only 3" clearance (additional clearance may be required for fluorescent light fixtures.)
- Acoustical—absorb at least 45% of all the sound that strikes surfaces
- Can be painted with no noticeable loss of acoustical efficiency

FASHIONTONE SUSPENDED CEILINGS

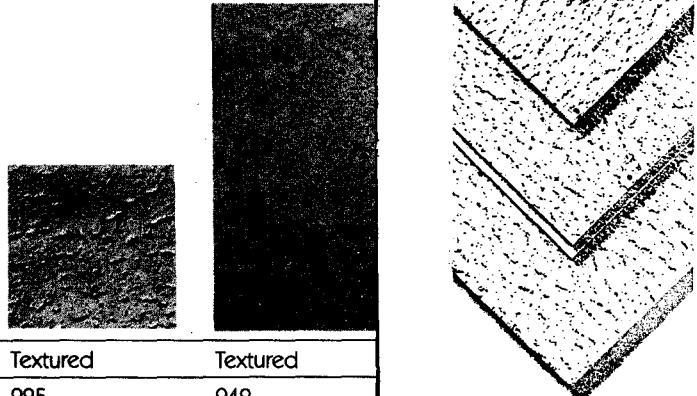

Product name	Textured	Textured
Item no.	925	942
NRC (minimum noise-reduction coefficient)	55%	55%
Size	2'x2'x5/8"	2'x4'x5/8"
Sq. ft. per carton	64	80
Special features	Fire-retardant, acoustical, 3-dimensional, washable	Fire-retardant, acoustical, washable
SKU NOS.	101740	101745

FISSURED PANELS—WHITE
 Material: is wet-formed mineral fiber factory-applied vinyl latex square edges, concealed tee grid traveretone tire guard is fire resistance by using UL fire resistive design.

SKU NO.	MFG. NO.	SIZE
101767	554	12" x 12" x 3/4"

FEATURES

- All Cushiontone Panels are acoustical; they absorb 45-55% of the sound that strikes their surfaces
- Scrubbable ceiling panels are available—offer even greater washability

TEMLOK TILE

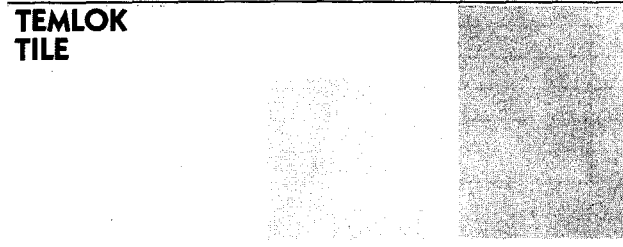

Product name	Washable White	Plain White
Item no.	231	280
Sq. ft. per carton	40	64
Special features	Washable	Washable
Size	12" x 12" x 1/2"	2' x 4' x 1/2"
SKU NOS.	101755	101730

Acoustical Products Company

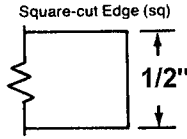
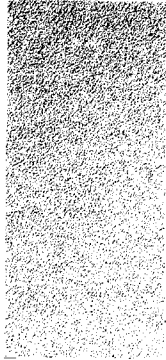

1/2' x 2' x 4' panel*
 square-cut edge (sq)
 • FIRECODE (2-mil White Vinyl)

Standard panels, with a FIRECODE "C" core and square-cut edges, come in 2' x 4' sizes, with a laminated white vinyl facing. The vinyl facing is a tough 2 mils thick and Stipple-pattern embossed for a soft, lightly-textured look. It resists soiling, and is easy to clean—two good reasons these panels have been USDA-accepted for food processing/service area. The unfinished-face panels provide a functional ceiling for applications where real bare-bones economy is the overriding criterion.

Easy Maintenance: embossed vinyl surface is washable to keep surface bright and light reflecting.

SKU NO.	Mfg. No.	Size
101810		2' x 4'

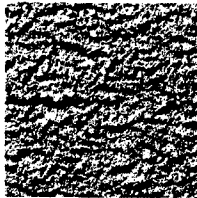

Acoustone

Heavily fissured, and rugged in feeling, Glacier pattern's deeply etched texture creates a natural ambiance. Overall roughness obscures joints in tile ceilings for the nearly monolithic tile look that suits any setting.

SKU NO.	Mfg. No.	Size	Color
101821	707-1	2' x 2'	White Glacia

Our catalog does not contain everything in our inventory. If there are products you do not find that are related to those in this catalog call 437-1288 so that we may assist you.

Shadow Line Edge (SL)

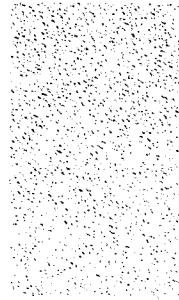
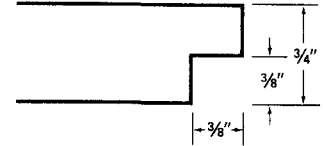

2' x 4' - sq.
 (Item # 2310)

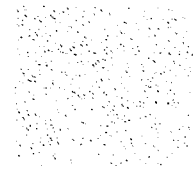

2' x 2' - SL
 (Item #324)

Auratone

Omni Fissured AURATONE Mineral Acoustical Panels and Tile are made up of mineral-wool fibers water-felted into units with excellent balance of sound absorption and sound attenuation. Omni Fissured, the only AURATONE Tile pattern available in color, is a versatile, nondirectional pattern of pin perforations and irregularly shaped fissures intermixed. It blends smoothly and unobtrusively with almost any decor.

SKU NO.	Mfg. No.	Size	Color
101744	2310	2' x 4'	White Square Edge

Second Look II

SKU NO.	Mfg. No.	Size	Color
101809	2767	2' x 4' x 3/4'	White Square Edge
			80 sq. ft/ctn

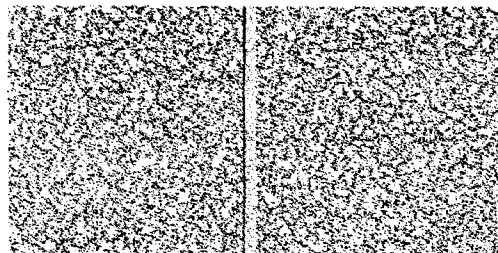

Second Look I
 scoring creates
 nominal 24" x 24"
 squares



ARTCREST PRODUCTS CO. INC.

Prism Panels

Petite recessed diamond prisms with conical cavities have universal acceptance for efficiency. Can be specified in all thicknesses, all sizes, clear or opal, styrene, acrylic, polycarbonate. Most commonly used in lighting fixtures.

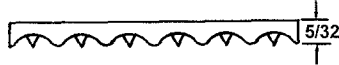
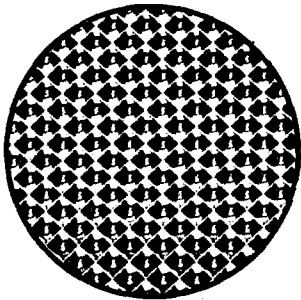

SKU	Mfg. No.	Size	Description
10600	AR12A100	2 x 4	Acrylic

ARVC Visual Comfort (Acrylic)

Uniformly aligned $\frac{5}{32}$ " square based conical prisms injection molded of clear acrylic avoiding distortion for uniformity .150" & .175" thickness-maximum size 2x4.

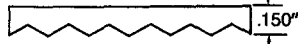

SKU NO.	Mfg. No.	Size	Description
106003	AR12AF125	1/8" x 22.5" x 46.5" Prism Clear	

SPARKLE GRAIN POLAR CLOUD (Opal) Acrylic/Styrene

Crepe finish, nondirectional and scratch resistant. Translucent *opal cloud* light pigmentation produces truer color definition. Excellent background for display and sales areas. May be specified in flat or formed sizes, various thicknesses. Popular internationally.

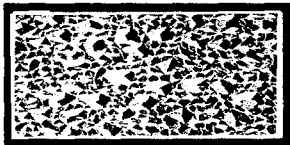

SKU NO.	Mfg. No.	Type	Size
103205	HDFW	Flat Opal	2' x 4' H.D.

HFW—FROST WHITE

Economical Non-Glare Smooth White. Styrene only. 2' x 2' and 2' x 4'.

SKU NO.	Mfg. No.	Type	Size
103185	HLC	Light Panel Clear	2' x 4'
103186	FHL	Frost White H.D.	2' x 4'

Plastic Louvers

(U.L. approved for use under sprinklers in approved grid)
 (When used in lighting fixtures, permit cooling for increased efficiency)

Cube Louvers (Styrene/Acrylic)

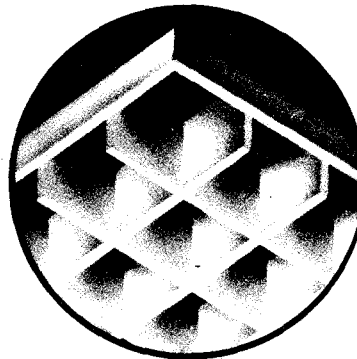

$\frac{1}{2}$ " x $\frac{1}{2}$ " x $\frac{1}{2}$ " full cube for true 45° shielding with $\frac{1}{4}$ " high lap edges. Economical $\frac{1}{2}$ " x $\frac{1}{2}$ " x $\frac{3}{8}$ " square cell up to 2' x 4' for 42° shielding.

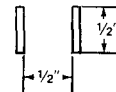

SKU NO.	Mfg. No.	Type	Size	Color
103200	PL-375	Egg Crate	2' x 4' x $\frac{3}{8}$ "	White
103195	PL-4 $\frac{1}{2}$	Egg Crate	2' x 4' x $\frac{1}{2}$ "	White
103203	LIPL21-245	Egg Crate	2' x 4' x $\frac{3}{8}$ "	Silver

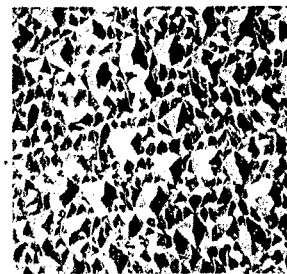

Cracked Ice Panel

Clear or White

C1A/C1-0A Random Gem-Faced

Unique multi-direction male protrusions with flat plane sides deliver light producing jewel-like action. Specify for busy, exotic surface. Clear and opal in acrylic and styrene. All sizes.

SKU NO.	Mfg. No.	Size	Type
		2' x 4'	
103215	C-I-C	Cracked Ice	Clear
103216	C-I-O	Cracked Ice	White

WE ALSO STOCK SPECIAL GOLD AND SILVER PARABOLIC LIGHT LOUVERS TO REDUCE GLARE AND INCREASE LIGHTING EFFICIENCY. CALL FOR DETAILS.

Republic doors • frames

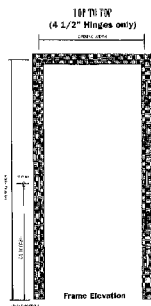

HOLLOW METAL FRAMES

FIRE RATED (Label)

DOORS & FRAMES SHOWN HERE ARE STOCK ITEMS. SEND US YOUR QUOTE REQUEST OR PRINTS FOR SPECIAL BUILDING PROJECTS.

OR...

CALL IF YOU CAN'T FIND WHAT YOU ARE LOOKING FOR.

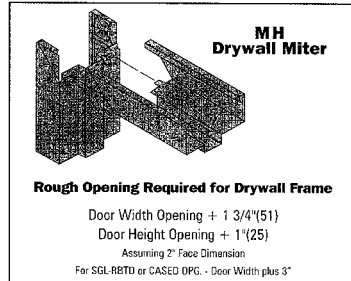
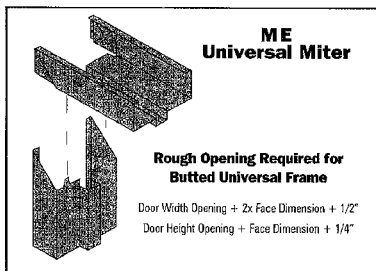

SIZE	SKU	SKU	INCLUDED:
<i>Masonry</i>	RH	LH	
3/0X6/8X5 3/4"	130499	130492	Closure reinforced/Wire hangers/Masonry
3/0X7/0X5 3/4"	300013	300018	Closure reinforced/Wire hangers/Masonry
<i>Drywall</i>			
2/6X6/8X4-7/8"	130383	130381	Closure reinforced/Plugs/Mutes/Dry wall clips
2/6X7/0X4-7/8"	130387	130385	Closure reinforced/Plugs/Mutes/Dry wall clips
2/8X7/0X4-7/8"	130493	130491	Closure reinforced/Plugs/Mutes/Dry wall clips
2/8X6/8X4-7/8"	130399	130397	Closure reinforced/Plugs/Mutes/Dry wall clips
3/6X6/8X4-7/8"	130520	130518	Closure reinforced/Plugs/Mutes/Dry wall clips
3/0X7/0X6-1/8"	310710	310705	Closure reinforced/Plugs/Mutes/Dry wall clips
3/0X7/0X7-2/8"	310720	310715	Closure reinforced/Plugs/Mutes/Dry wall clips
3/6X7/0X4-7/8"	130525	130528	Closure reinforced/Plugs/Mutes/Dry wall clips
3/0X6/8X4-7/8"	130478	130480	Closure reinforced/Plugs/Mutes/Dry wall clips
3/0X7/0X4-7/8"	130497	130499	Closure reinforced/Plugs/Mutes/Dry wall clips
4/0X6/8X4-7/8"	300093	300094	Closure reinforced/Plugs/Mutes/Dry wall clips
4/0X7/0X4-7/8"	300099	300100	Closure reinforced/Plugs/Mutes/Dry wall clips
<i>Welded</i>			
3/0X7/0X5 3/4"	300027	300030	Specify anchors
Non handed-Double Door Frames			
<i>Masonry</i>			
6/0X6/8X5 3/4"	300039		Closure Reinforced/Flush Bolt Prep/Wire Anchors
6/0X7/0X5 3/4"	300021		Closure Reinforced/Flush Bolt Prep/Wire Anchors
<i>Drywall</i>			
6/0X6/8X4-7/8"	300036		Closure reinforced/Flush bolt prep/Dry wall clips
6/0X7/0X4-7/8"	300024		Closure reinforced/Flush bolt prep/Dry wall clips
<i>Case Open</i>			
3/0X6/8X4-7/8"	308705		Closure reinforced/Dry wall clips
3/0X7/0X4-7/8"	308700		Closure reinforced/Dry wall clips

HOLLOW METAL DOORS - FIRE RATED (Label)



(UL & WH/ITS Label)
 Tested to UBC 7-2 and UL IOC
 Positive Pressure Standard



Honeycomb (Standard)

- Efficient in 95% of all weather conditions
- STC rating of 38 standard. U Factor of .342.

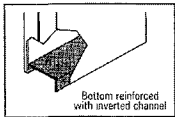

Bottom reinforced with inverted channel

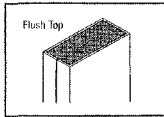

Flush Top

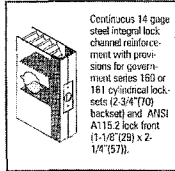

Continuous 14 gage steel integral lock channel reinforcement with provisions for government series 160 or 161 cylindrical locksets (2-3/4" top backset) and ANSI A115-2 lock front (1-1/8" (29) x 2-1/4" (57)).

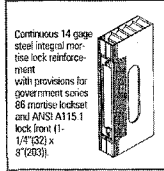

Continuous 14 gage steel integral mortise lock reinforcement with provisions for government series 88 mortise lockset and ANSI A115-1 lock front (1-1/4" (32) x 3" (76)).

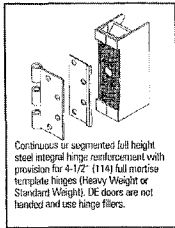

Continuous or segmented full height steel integral hinge reinforcement with provision for 4-1/2" (114) full mortise template hinges (Heavy Weight or Standard Weight). DE doors are not finished and use hinge fillers.

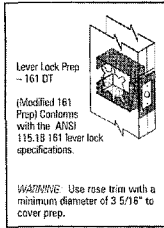

Lever Lock Prep - 161 DT
 (Modified 161 Prep) Conforms with the ANSI 115.19 161 lever lock specifications.
 WARNING: Use rose trim with a minimum diameter of 3 5/16" to cover prep.

SKU	Hollow Metal SIZE	PREP	
300032	3/0X6/8X1-3/4"	MORTISE	
300033	3/0X7/0X1-3/4"	MORTISE	
300096	4/0X6/8X1-3/4"	CYL	
300139	3/6X7/0X1-3/4"	MORTISE	
300137	3/6X7/0X1-3/4"	CYL	
300037	4/0X7/0X1-3/4"	CYL	
130485	3/0X6/8X1-3/4"	CYL	
130495	3/0X7/0X1-3/4"	CYL	
Machined to Ceco Specs			
305000	3/0X6/8X1-3/4"	CYL	
305005	3/0X7/0X1-3/4"	CYL	
Astragal			
300042	(6/8)	RH	
300048	(6/8)	LH	
300051	(7/0)	RH	
300054	(7/0)	LH	
SOLID CORE WOOD MACHINED TO REPUBLIC			
103297	3/0X6/8X1-3/4"	BIRCH	RH
103293	3/0X6/8X1-3/4"	BIRCH	LH
103300	3/0X7/0X1-3/4"	BIRCH	RH
103305	3/0X7/0X1-3/4"	BIRCH	LH
103320	3/0X7/0X1-3/4"	BIRCH	RH-No Lock Prep
103325	3/0X7/0X1-3/4"	BIRCH	LH-No Lock Prep
103315	3/0X7/0X1-3/4"	OAK	RH
103310	3/0X7/0X1-3/4"	OAK	LH

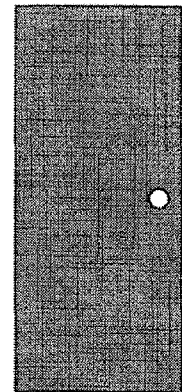

Single Door

Stock doors are fabricated from cold rolled 18 ga. steel. 16ga. or 20ga. doors can be ordered as well as galvanized.

LABEL CLASSIFICATIONS

LABEL CLASSIFICATION	LOCATION IN BUILDING	MAXIMUM GLASS AREA
A 3 HOUR RATING	Class "A" openings are in walls separating buildings or dividing a single building into fire areas. Doors for these openings require a fire protection rating of 3 hours and no glass is permitted.	NONE ALLOWED
B 1 1/2 HOUR RATING	Class "B" openings are in enclosures of vertical communication through buildings. These could be stairwells or elevator shafts. Doors therefore require a fire protection rating of 1 1/2 hours.	100 square inches per leaf
C 3/4 Hr. RATING	Class "C" openings are in corridors and room partitions. Doors for these areas require a fire protection rating of 3/4-hour, and the glass area cannot exceed 1296 square inches per light with no dimension exceeding 54 inches.	1296 sq. in. No dimension to exceed 54"



VISION-LITES

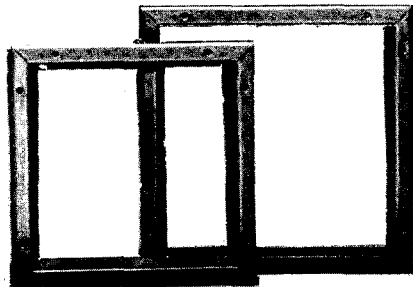

MODELS 84G AND T4G GLASS FRAMES

UNDERWRITERS' LABORATORIES

Frame structures are listed when installed in classified Fire Doors, using approved installation methods.
 No need for precise cut-outs. Works to

a rough opening – just as with door louvers. Tight to door surface – with direct screw attachment. For hollow core wood and plastic door use plastic screw anchors or Molly fasteners. Listed applications require special fasteners. Use Kit 115127 for Wood Doors.

SKU NO.	MFG. NO.	SIZE
300120	84G	10" x 10"
300140	84G	5" x 20"
300155	84G	24" x 30"

DOOR SIZE	Rough opening size
1 3/4"	1 1/2" wider & higher than exposed glass

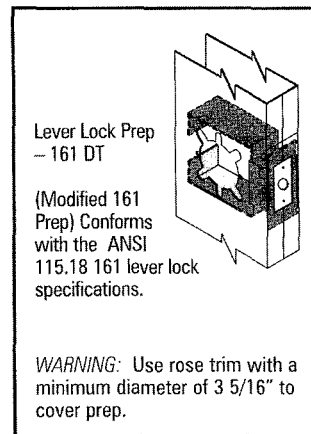
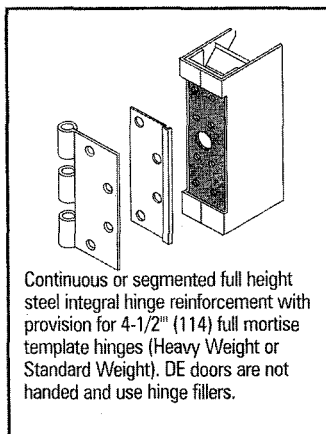
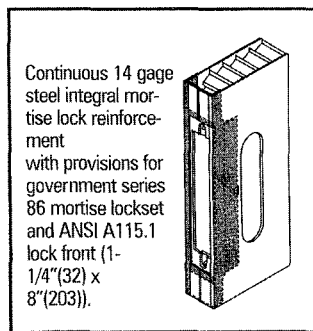
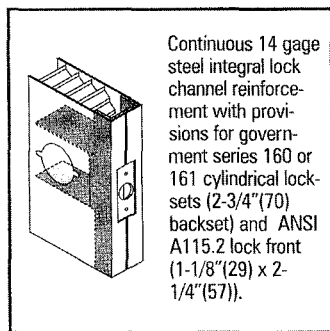
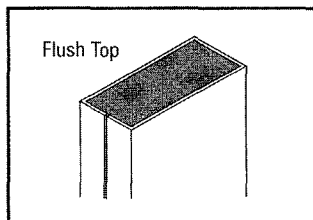
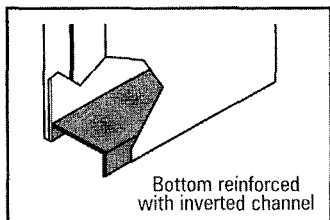

FRAME ANCHORS

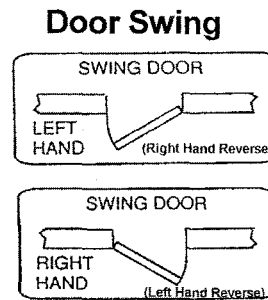
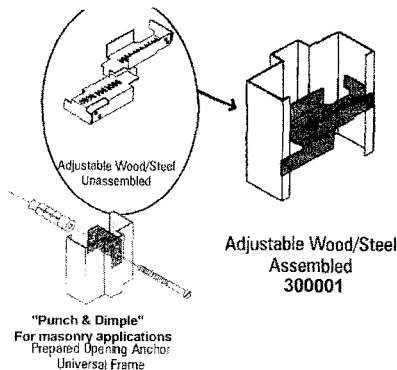
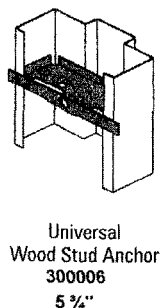
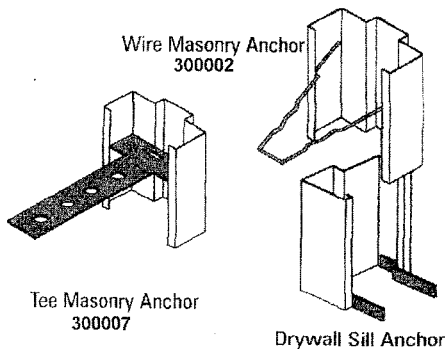

2-DOOR BI-FOLD LUAN

SKU NO.	Size
100950	2' - 0" x 6' - 8" x 1 ³ / ₈ "
100960	2' - 8" x 6' - 8" x 1 ³ / ₈ "
100965	3' - 0" x 6' - 8" x 1 ³ / ₈ "

2-DOOR BI-FOLD BIRCH

SKU NO.	SIZE
101104	2' - 6" x 6' - 8" x 1 ³ / ₈ "
101107	3' - 0" x 6' - 8" x 1 ³ / ₈ "

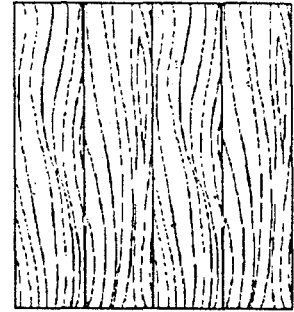

4-DOOR BI-FOLD LUAN

SKU NO.	Size
100970	4' - 0" x 6' - 8" x 1 ³ / ₈ "
100980	6' - 0" x 6' - 8" x 1 ³ / ₈ "

4-DOOR BI-FOLD BIRCH

SKU NO.	SIZE
101109	4' - 0" x 6' - 8" x 1 ³ / ₈ "
101112	6' - 0" x 6' - 8" x 1 ³ / ₈ "
101111	5' - 0" x 6' - 8" x 1 ³ / ₈ "

8' x 0" high units in birch, oak, luan, louver, louver panel and 6 panel colonial doors are available on special order.

**FULL LOUVER
 2-DOOR BI-FOLD UNITS
 6' - 8" HIGH 1¹/₈" THICK**

PINE	
FINISH	JD- 730
OPENING SIZE	1 ¹ / ₈ "
2' - 0" x 6' - 8 ¹ / ₂ "	101020
2' - 6" x 6' - 8 ¹ / ₂ "	101025
3' - 0" x 6' - 8 ¹ / ₂ "	101035

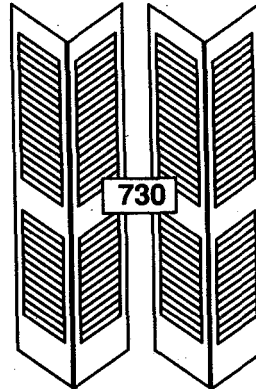

**PINE 4-DOOR BI-FOLD UNITS
 6' - 8" HIGH 1¹/₈" THICK**

PINE	
FINISH	JD- 730
OPENING SIZE	1 ¹ / ₈ "
4' - 0" x 6' - 8 ¹ / ₂ "	101040
6' - 0" x 6' - 8 ¹ / ₂ "	101050

UNFINISHED PREHUNG DOORS

1-3/8" HOLLOW CORE LUAN

4-9/16" Luan Veneer MDF jamb. Round Edge
 Luan Stop. 1-1/2pr of 3-1/2" Brass Hinges. 2-3/4" Backset
 No Casing - No Lock

1-3/8" HOLLOW CORE BIRCH

4-9/16" Birch Veneer MDF Jamb. Colonial Birch Stop
 1-1/2pr of 3-1/2" Brass Hinges - 2-3/4" Backset
 No Casing - No Lock

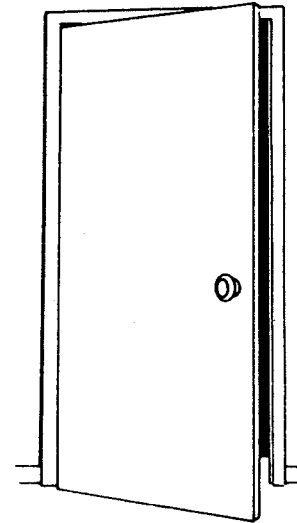

INTERIOR HOLLOW CORE

SIZE	1 ³ / ₈ " BIRCH H.C. RIGHT HAND	1 ³ / ₈ " BIRCH LEFT HAND	1 ³ / ₈ " LUAN RIGHT HAND	1 ³ / ₈ " LUAN LEFT HAND
2' - 0" x 6' - 8"	—	—	104055	104060
2' - 2" x 6' - 8"	—	—	104065	104070
2' - 4" x 6' - 8"	—	—	104075	104080
2' - 6" x 6' - 8"	104115	104120	104085	104090
2' - 8" x 6' - 8"	104125	104130	104095	104100
2' - 10" x 6' - 8"	—	—	—	—
3' - 0" x 6' - 8"	104135	104140	104105	104110
3' - 0" x 7' - 0"	—	—	—	—

1-3/8" HOLLOW CORE OAK

4-9/16" Oak Veneer MDF Jamb. Colonial Oak Stop
 1-1/2pr of 3-1/2" Brass Hinges. 2-3/4" Backset
 No Casing - No Lock

SIZE	RIGHT HAND	LEFT HAND
2/6 x 6/8	104145	104150
2/8 x 6/8	104155	104160
3/0 x 6/8	104165	104170

Passage knobsets can be upgraded to Privacy or keyed locksets or lever locksets for ADA compliance at an additional charge. Sizes listed are door sizes. Allow 2 inches for rough opening.

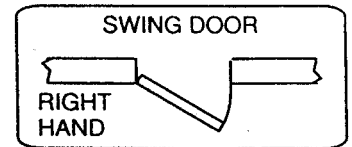
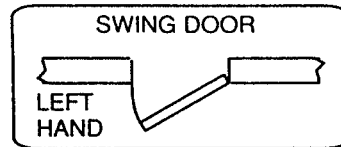

1-3/4" SOLID CORE LUAN

4-13/16" Poplar Veneer Woodback Jamb. Round Edge
 Poplar Stop. 1-1/2pr of 3-1/2" Brass Hinges 2-3/4" backset
 No Casing - No Lock

SIZE	1 ³ / ₄ " LUAN RIGHT HAND	1 ³ / ₄ " LUAN LEFT HAND
3' - 0" x 6' - 8"	100835	100830
3' - 0" x 7' - 0"	100845	100840

DOOR FRAMES (JAMB SETS)

	3/4" THICK INTERIOR		1 1/4" THICK EXTERIOR	
	4 5/8" WIDE	5 1/4" WIDE	4 5/8" WIDE	5 1/4" WIDE
3' - 0" Header	101105	101115	101140	101150
6' - 8" Side	101100	101110	101135	101145
7' - 0" Side	101125	101130	—	101155
6' - 8" Set 1-Header 2-Sides	101106	101116	101141	101151
7' - 0" Set 1-Header 2-Sides	101126	101131	—	101156

WOOD DOORS

1

FLUSH DOORS-HOLLOW CORE

To avoid warpage and protect your doors all faces and edges must be painted or coated.

SIZE	1 ³ / ₈ " BIRCH	1 ³ / ₈ " LUAN	1 ³ / ₈ " OAK	1 ³ / ₄ " BIRCH	1 ³ / ₄ " LUAN
2' - 0" x 6' - 8"	100350	100315	—	—	—
2' - 2" x 6' - 8"	100355	100320	—	—	—
2' - 4" x 6' - 8"	100360	100325	101089	—	—
2' - 6" x 6' - 8"	100365	100330	101090	—	—
2' - 8" x 6' - 8"	100370	100335	101095	100695	—
3' - 0" x 6' - 8"	100380	100345	101098	100705	100665
3' - 0" x 7' - 0"	—	—	—	100725	100685

NOTE: Doors may be trimmed 1" top and bottom (2" total)
 Doors may be trimmed 1/4" each side (1/2" total)

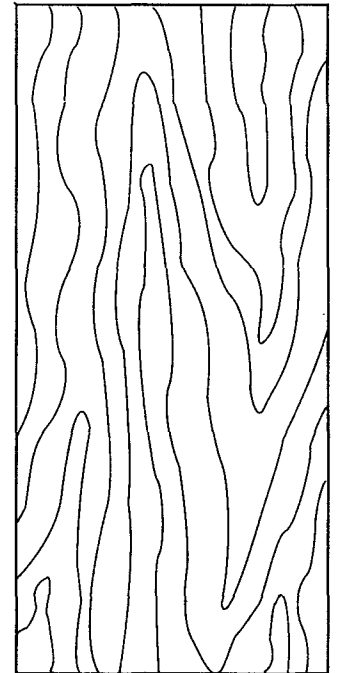

FLUSH DOORS-SOLID CORE

SIZE	1 ³ / ₄ " BIRCH	1 ³ / ₄ " LUAN	1 ³ / ₄ " OAK
2' - 6" x 6' - 8"	—	100525	—
2' - 8" x 6' - 8"	100575	100530	—
3' - 0" x 6' - 8"	100585	100540	100588
3' - 0" x 7' - 0"	100605	100560	—

HARDWOOD DOOR LOUVRES

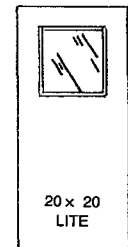
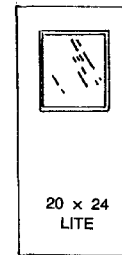
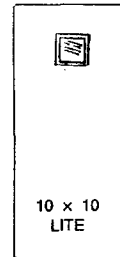
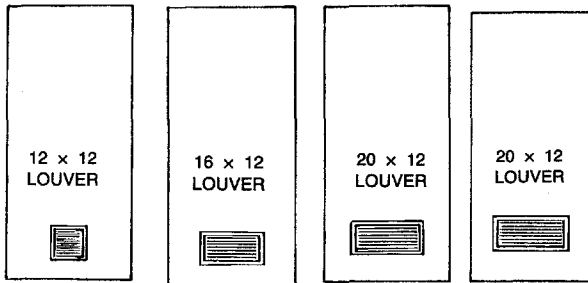

101670	Hardwood Door Louvres For 1 ³ / ₄ "	12 x 12
101675	Hardwood Door Louvres For 1 ³ / ₄ "	16 x 12
101680	Hardwood Door Louvres For 1 ³ / ₄ "	20 x 12
101700	Hardwood Door Louvres For 1 ³ / ₈ "	12 x 12
101705	Hardwood Door Louvres For 1 ³ / ₈ "	16 x 12
101710	Hardwood Door Louvres For 1 ³ / ₈ "	20 x 12

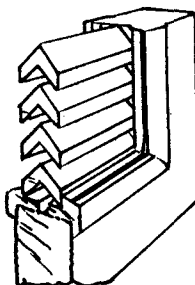

DOOR LIGHTS

SKU	DESCRIPTION	SIZE
101630	Door Lites For 1 ³ / ₄ " Doors	20 x 24
101635	Door Lites For 1 ³ / ₄ " Doors	20 x 20
101640	Door Lites For 1 ³ / ₄ " Doors	10 x 10
101645	Door Lites For 1 ³ / ₄ " Doors	6 x 10
101650	Door Lites For 1 ³ / ₈ " Doors	20 x 24
101660	Door Lites For 1 ³ / ₈ " Doors	10 x 10

PINE MOULDING

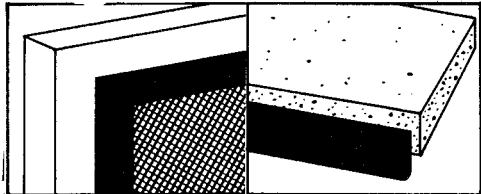

Covers seam where screening is fastened to the screen frame.

Also covers particle or flakeboard shelf edges.



SCREEN BEAD FLAT WP142 1/4 x 3/4	
LENGTH PIECE	SKU NO.
8'	101540-08
10'	101540-10
12'	101540-12
14'	101540-14
16'	101540-16

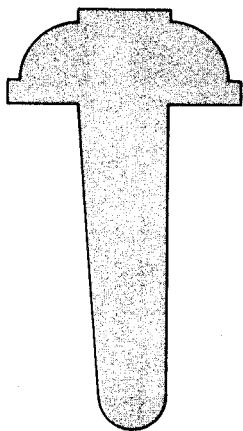

ASTRAGAL 6P/M-997	
LENGTH PIECE	SKU NO.
1 1/4" x 2 1/4" x 7'	101250-07



SCREEN BEAD BEADED WP144 1/4 x 3/4	
LENGTH PIECE	SKU NO.
8'	101545-08
10'	101545-10
12'	101545-12
14'	101545-14
16'	101545-16

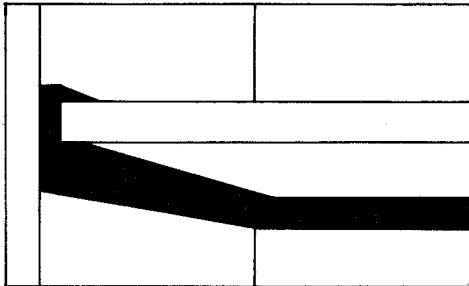

Commonly used in closets, cabinets & book cases to support the shelves. Also called Shelf Strip.



SHELF CLEAT LWM990 11/16 x 1-1/2	
LENGTH PIECE	SKU NO.
8'	101560-08
10'	101560-10
12'	101560-12
14'	101560-14
16'	101560-16

PLASTIC TRIM

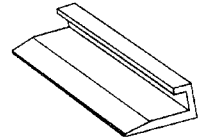

CAPS

SKU NO.	MFG. NO.	COLORS
101875	PVC-1/4"	White Trim
101881	PVC-1/8"	White Trim
101877	PVC-1/4"	Black Trim
101874	PVC-1/4"	Black Trim

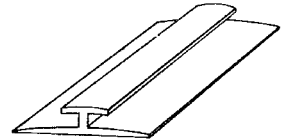

DIVIDERS

SKU NO.	MFG. NO.	COLORS
101920	1/4" PVC	White Trim
101927	1/8" PVC	White Trim
101919	1/4" PVC	Black Trim

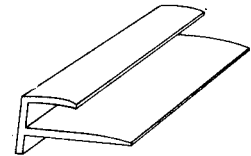

OUTSIDE CORNER

SKU NO.	MFG. NO.	COLOR
101926	1/4" PVC	Black Trim
101905	1/4" PVC	White Trim
101946	1/8" PVC	White Trim

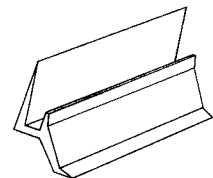

INSIDE CORNER

SKU NO.	MFG. NO.	COLORS
101890	1/4" PVC	White Trim
101896	1/8" PVC	White Trim
101834	1/4" PVC	Black Trim

PINE MOULDING



**STOP RANCH
WP848
7/16 x 1-1/8**

LENGTH PIECE	SKU NO.
8'	101570-08
10'	101570-10
12'	101570-12
14'	101570-14
16'	101570-16

**STOP RANCH
WP846
7/16 x 1-3/8**

LENGTH PIECE	SKU NO.
8'	101575-08
10'	101575-10
12'	101575-12
14'	101575-14
16'	101575-16

**STOP RANCH
WP845
7/16 x 1-5/8**

LENGTH PIECE	SKU NO.
8'	101580-08
10'	101580-10
12'	101580-12
14'	101580-14
16'	101580-16

**STOP RANCH
LWP843
7/16 x 2-1/8**

LENGTH PIECE	SKU NO.
8'	101585-08
10'	101585-10
12'	101585-12
14'	101585-14
16'	101585-16

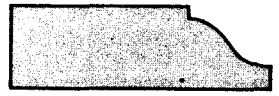

**STOP COLONIAL
WP936
7/16 x 3/8**

LENGTH PIECE	SKU NO.
8'	101590-08
10'	101590-10
12'	101590-12
14'	101590-14
16'	101590-16

**STOP COLONIAL
WP935
7/16 x 1-5/8**

LENGTH PIECE	SKU NO.
8'	101595-08
10'	101595-10
12'	101595-12
14'	101595-14
16'	101595-16

**STOP COLONIAL
LWP933
7/16 x 2-1/8**

LENGTH PIECE	SKU NO.
8'	101600-08
10'	101600-10
12'	101600-12
14'	101600-14
16'	101600-16

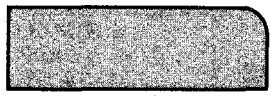

**STOP ROUND EDGE
WP878
7/16 x 1-1/8**

LENGTH PIECE	SKU NO.
8'	101605-08
10'	101605-10
12'	101605-12
14'	101605-14
16'	101605-16

**STOP ROUND EDGE
WP876
7/16 x 1-3/8**

LENGTH PIECE	SKU NO.
8'	101610-08
10'	101610-10
12'	101610-12
14'	101610-14
16'	101610-16

**STOP ROUND EDGE
WP875
7/16 x 1-5/8**

LENGTH PIECE	SKU NO.
8'	101615-08
10'	101615-10
12'	101615-12
14'	101615-14
16'	101615-16

**STOP ROUND EDGE
LWP873
7/16 x 2-1/8**

LENGTH PIECE	SKU NO.
8'	101620-08
10'	101620-10
12'	101620-12
14'	101620-14
16'	101620-16

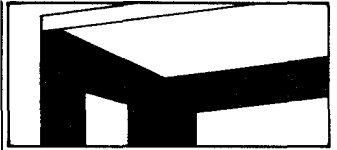

Same basic uses as Squares.

**PARTING STOP
WP254
1/2 x 3/4**

LENGTH PIECE	SKU NO.
8'	101505-08
10'	101505-10
12'	101505-12
14'	101505-14
16'	101505-16

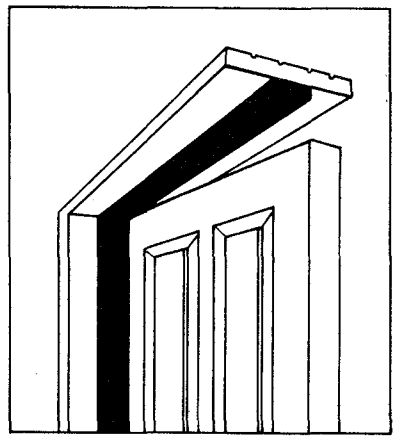

In door trim, Stop is nailed to the faces of the door frame to prevent the door from swinging through. As window trim, Stop holds the bottom sash of a double-hung window in place. Also used as an apron under window stools.

PINE MOULDING

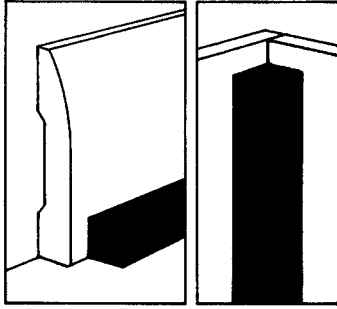

May be used as a Base Shoe, Inside Corner Moulding, or to cover any 90° recessed juncture.

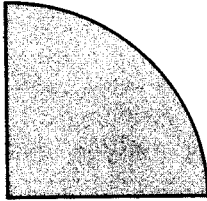

QUARTER ROUND LWP103 1-1/16 x 1-1/16	
LENGTH PIECE	SKU NO.
8'	101530-08
10'	101530-10
12'	101530-12
14'	101530-14
16'	101530-16

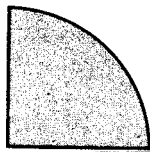

QUARTER ROUND WP105 3/4 x 3/4	
LENGTH PIECE	SKU NO.
8'	101525-08
10'	101525-10
12'	101525-12
14'	101525-14
16'	101525-16



QUARTER ROUND WP108 1/2 x 1/2	
LENGTH PIECE	SKU NO.
8'	101520-08
10'	101520-10
12'	101520-12
14'	101520-14
16'	101520-16



QUARTER ROUND WP110 1/4 x 1/4	
LENGTH PIECE	SKU NO.
8'	101515-08
10'	101515-10
12'	101515-12
14'	101515-14
16'	101515-16

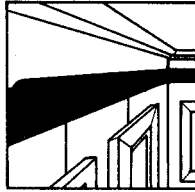

Used to support hooks for picture hanging. Applied around a room's circumference near the ceiling line.

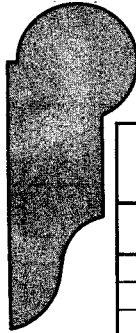

PICTURE MOLD M-8263 11/16 x 1-3/4	
LENGTH PIECE	SKU NO.
7'	101510-07
8'	101510-08
10'	101510-10
12'	101510-12
14'	101510-14
16'	101510-16

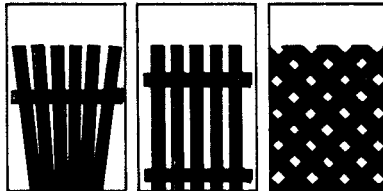

Originally used in trellis work. This small, plain S4S Moulding is among the most versatile of profiles.

LATTICE LWP268 1/4 x 1-1/8	
LENGTH PIECE	SKU NO.
8'	101460-08
10'	101460-10
12'	101460-12
14'	101460-14
16'	101460-16

LATTICE LWP267 1/4 x 1 3/8	
LENGTH PIECE	SKU NO.
8'	101465-08
10'	101465-10
12'	101465-12
14'	101465-14
16'	101465-16

LATTICE LWP265 1/4 x 1-3/4	
LENGTH PIECE	SKU NO.
8'	101470-08
10'	101470-10
12'	101470-12
14'	101470-14
16'	101470-16

LATTICE LWP264 1/4 x 2	
LENGTH PIECE	SKU NO.
8'	101475-08
10'	101475-10
12'	101475-12
14'	101475-14
16'	101475-16

LATTICE LWP261 1/4 x 2-1/2	
LENGTH PIECE	SKU NO.
8'	101485-08
10'	101485-10
12'	101485-12
14'	101485-14
16'	101485-16

LATTICE M-8282 R 1/4 x 3-1/2	
LENGTH PIECE	SKU NO.
8'	101490-08
10'	101490-10
12'	101490-12
14'	101490-14
16'	101490-16

LATTICE LWP260 5/16 x 5-1/2	
LENGTH PIECE	SKU NO.
8'	101495-08
10'	101495-10
12'	101495-12
14'	101495-14
16'	101495-16

PINE MOULDING

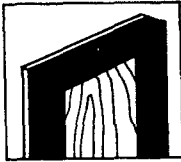

Used in cabinets, framing for shelves or other utilitarian uses. Also used as baluster for supporting stair handrails.

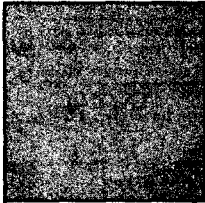

BALUSTER WP239 3/4 x 3/4	
LENGTH PIECE	SKU NO.
8'	101255-08
10'	101255-10
12'	101255-12
14'	101255-14
16'	101255-16

BALUSTER WP238 1-1/16 x 1-1/16	
LENGTH PIECE	SKU NO.
8'	101260-08
10'	101260-10
12'	101260-12
14'	101260-14
16'	101260-16

BALUSTER WP237 1-5/16 x 1-5/16	
LENGTH PIECE	SKU NO.
8'	101265-08
10'	101265-10
12'	101265-12
14'	101265-14
16'	101265-16



Applied where floor & walls meet, forming a visual foundation. Protects walls from kicks, bumps, furniture, etc. Base may be referred to as One, Two or Three-Member. Base Shoe & Base Cap are used to conceal uneven floor & wall junctions.

BASES RANCH LWP713 7/16 x 3-1/4	
LENGTH PIECE	SKU NO.
8'	101275-08
10'	101275-10
12'	101275-12
14'	101275-14
16'	101275-16

BASES COLONIAL WP633 7/16 x 3-1/4	
LENGTH PIECE	SKU NO.
8'	101280-08
10'	101280-10
12'	101280-12
14'	101280-14
16'	101280-16

BASES COLONIAL WP630 1/2 x 4-1/4	
LENGTH PIECE	SKU NO.
8'	101285-08
10'	101285-10
12'	101285-12
14'	101285-14
16'	101285-16

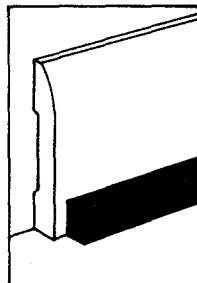

Applied where Base Moulding meets floor. Protects Base from damage. Conceals uneven lines or cracks where Base meets floor.

BASES SHOE WP126 1/2 x 3/4	
LENGTH PIECE	SKU NO.
8'	101295-08
10'	101295-10
12'	101295-12
14'	101295-14
16'	101295-16

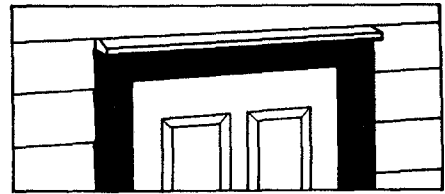

Used as an exterior door & window Casing. A thick Moulding providing a surface for brick or other siding to butt against.



BRICK MOULD F.J. WP180 1-1/4 x 2	
LENGTH PIECE	SKU NO.
7'	101300-07
10'	101300-10
11'	101300-11
17'	101300-17

Trims out the upper edge or top of a Wainscot. Covers plywood's rough sandwich edge in installations where it's exposed to view. Also called a Dado Cap.

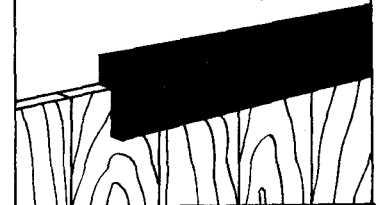

MODERN CAP M-294 11/16 x 1-1/8	
LENGTH PIECE	SKU NO.
7'	101305-07
8'	101305-08
10'	101305-10
12'	101305-12
14'	101305-14
15'	101305-15
16'	101305-16

PINE MOULDING

1

COLONIAL CAP M-292 9/16 x 1-1/8	
LENGTH PIECE	SKU NO.
8'	101310-08
9'	101310-09
10'	101310-10
12'	101310-12
14'	101310-14
15'	101310-15
16'	101310-16



CASING RE LWP492 7/16 x 2-1/2	
LENGTH PIECE	SKU NO.
8'	101340-08
10'	101340-10
12'	101340-12
14'	101340-14
16'	101340-16

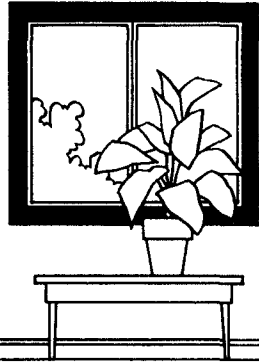

CASING

Used to trim inside and outside door & window openings.

CASINGS COLONIAL LWP351 11/16 x 2-1/2	
LENGTH PIECE	SKU NO.
7'	101320-07
8'	101320-08
10'	101320-10
12'	101320-12
14'	101320-14
16'	101320-16

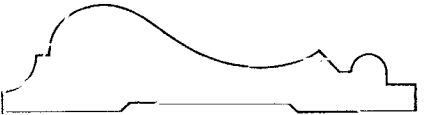
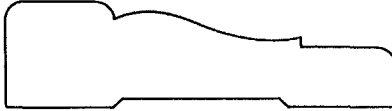

CHAIR RAIL COLONIAL LWP390 5/8 x 2-1/2	
LENGTH PIECE	SKU NO.
8'	101351-08
10'	101351-10
12'	101351-12
14'	101351-14
16'	101351-16

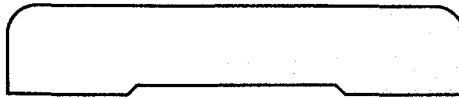

RANCH CASING LWP327 11/16 x 2-1/4	
LENGTH PIECE	SKU NO.
7'	101315-07
8'	101315-08
10'	101315-10
12'	101315-12
14'	101315-14
16'	101315-16

CASING 2 RE LWP432 9/16 x 3-1/2	
LENGTH PIECE	SKU NO.
8'	101335-08
10'	101335-10
12'	101335-12
14'	101335-14
16'	101335-16

Used in highway & dam construction forms, making a chamfered edge at concrete corners. Also used where kitchen cabinet tops meet the wall. Also used as a linoleum Cove, (under linoleum where it extends up the wall).

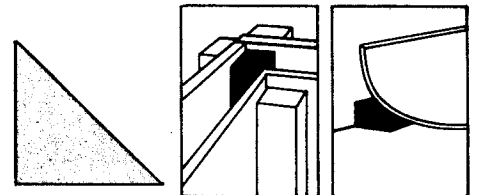
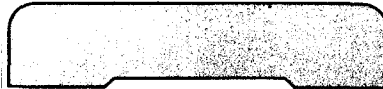
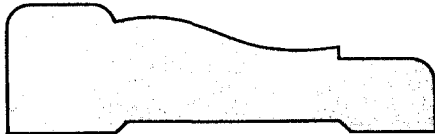

CASINGS COLONIAL LWP356 11/16 x 2-1/4	
LENGTH PIECE	SKU NO.
7'	101330-07
8'	101330-08
10'	101330-10
12'	101330-12
14'	101330-14
16'	101330-16

CASING 2 RE 8311 9/16 x 5-1/2	
LENGTH PIECE	SKU NO.
8'	101337-08
10'	101337-10
12'	101337-12
14'	101337-14
16'	101337-16

CHAMFER STRIP WP995 3/4 x 3/4	
LENGTH PIECE	SKU NO.
8'	101355-08
10'	101355-10
12'	101355-12
14'	101355-14
16'	101355-16

PINE MOULDING

1

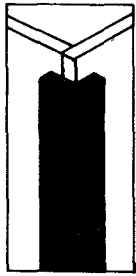

Outside (OS) Corner Guard is used to protect corners or to cover ragged edge where wall covering and painted surfaces meet at outside corner.



COVE LWP93 1/2 x 1/2	
LENGTH PIECE	SKU NO.
8'	101375-08
10'	101375-10
12'	101375-12
13'	101375-13
14'	101375-14
16'	101375-16

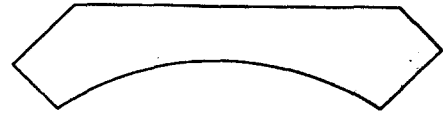

COVE WP84 11/16 x 2-1/4	
LENGTH PIECE	SKU NO.
8'	101390-08
10'	101390-10
12'	101390-12
14'	101390-14
16'	101390-16

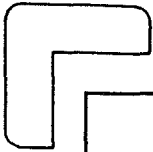

CORNER BEAD LWP205 3/4 x 3/4	
LENGTH PIECE	SKU NO.
8'	101360-08
10'	101360-10
12'	101360-12
13'	101360-13
14'	101360-14
16'	101360-16

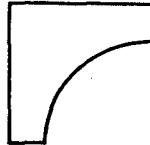

COVE WP93 3/4 x 3/4	
LENGTH PIECE	SKU NO.
8'	101380-08
10'	101380-10
12'	101380-12
14'	101380-14
16'	101380-16

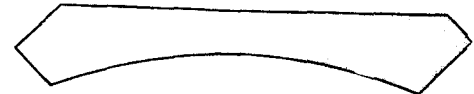

COVE WP81 11/16 x 3-1/4	
LENGTH PIECE	SKU NO.
8'	101395-08
10'	101395-10
12'	101395-12
14'	101395-14
16'	101395-16

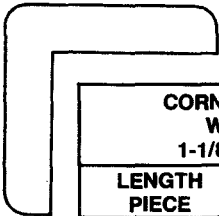

CORNER BEAD WP205 1-1/8 x 1-1/8	
LENGTH PIECE	SKU NO.
8'	101365-08
10'	101365-10
12'	101365-12
14'	101365-14
16'	101365-16

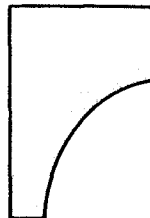

COVE WP90 11/16 x 1-1/8	
LENGTH PIECE	SKU NO.
8'	101400-08
10'	101400-10
12'	101400-12
14'	101400-14
16'	101400-16

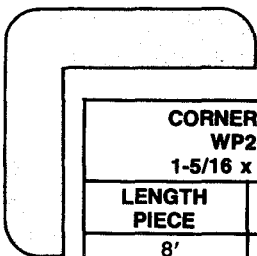
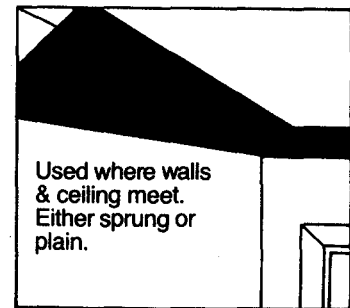

CORNER BEAD WP203 1-5/16 x 1-5/16	
LENGTH PIECE	SKU NO.
8'	101370-08
10'	101370-10
12'	101370-12
14'	101370-14
16'	101370-16



COVE WP85 11/16 x 1-3/4	
LENGTH PIECE	SKU NO.
8'	101385-08
10'	101385-10
12'	101385-12
14'	101385-14
16'	101385-16

CROWN LWP74 11/16 x 1-3/4	
LENGTH PIECE	SKU NO.
8'	101405-08
10'	101405-10
12'	101405-12
14'	101405-14
16'	101405-16

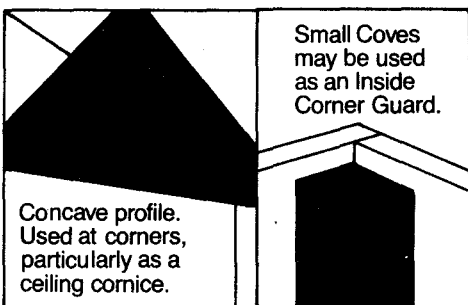

PINE MOULDING

1

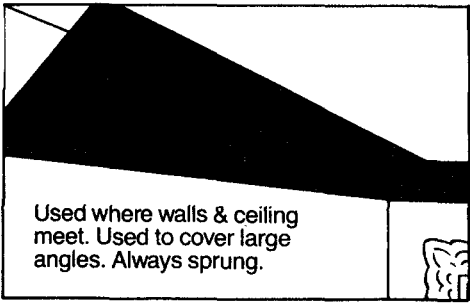

Used where walls & ceiling meet. Used to cover large angles. Always sprung.

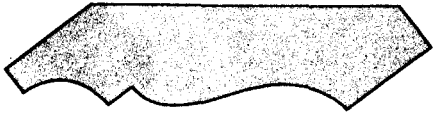

CROWN LWP54 11/16 x 2-1/4	
LENGTH PIECE	SKU NO.
8'	101407-08
10'	101407-10
12'	101407-12
14'	101407-14
16'	101407-16



CROWN LWP51 11/16 x 3-1/4	
LENGTH PIECE	SKU NO.
8'	101410-08
10'	101410-10
12'	101410-12
14'	101410-14
16'	101410-16



Applied over exterior window & door frames
 Keeps water from seeping under the siding.
 Also directs water away from window glass.

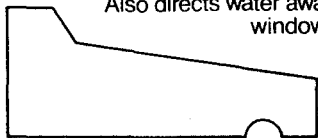

DRIP CAPS LWP192 11/16 x 1-5/8	
LENGTH PIECE	SKU NO.
8'	101415-08
10'	101415-10
12'	101415-12
14'	101415-14
16'	101415-16

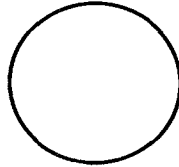

CLOSET POLE LWP233 FULL ROUNDS 1-1/16"	
LENGTH PIECE	SKU NO.
8'	101420-08
10'	101420-10
11'	101420-11
12'	101420-12
13'	101420-13
14'	101420-14
15'	101420-15
16'	101420-16

CLOSET POLE LWP233 FULL ROUNDS 1-1/4"	
LENGTH PIECE	SKU NO.
8'	101425-08
9'	101425-09
10'	101425-10
12'	101425-12
14'	101425-14
15'	101425-15
16'	101425-16

FULL ROUNDS LWP232 1-9/16	
LENGTH PIECE	SKU NO.
8'	101430-08
10'	101430-10
11'	101430-11
12'	101430-12
15'	101430-15
16'	101430-16



Used to hold glass in place. Also called Glass Stop, Cove & Bead, Putty Bead, Glazing Bead and Staff Bead.



GLASS BEAD WP148 3/8 x 3/8	
LENGTH PIECE	SKU NO.
8'	101435-08
10'	101435-10
12'	101435-12
14'	101435-14
16'	101435-16



GLASS BEAD WP147 1/2 x 9/16	
LENGTH PIECE	SKU NO.
8'	101440-08
10'	101440-10
12'	101440-12
14'	101440-14
16'	101440-16

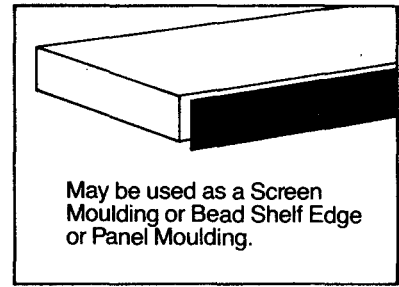

May be used as a Screen Moulding or Bead Shelf Edge or Panel Moulding.



HALF ROUNDS WP123 5/16 X 5/8	
LENGTH PIECE	SKU NO.
8'	101445-08
10'	101445-10
12'	101445-12
14'	101445-14
16'	101445-16



HALF ROUNDS LWP120 7/16 x 1	
LENGTH PIECE	SKU NO.
8'	101450-08
10'	101450-10
12'	101450-12
14'	101450-14
16'	101450-16

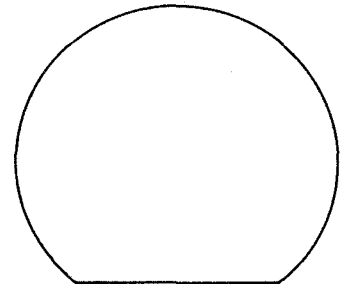

HAND RAIL LWP231 1-1/2 x 1-9/16	
LENGTH PIECE	SKU NO.
8'	101455-08
10'	101455-10
11'	101455-11
12'	101455-12
14'	101455-14
16'	101455-16

PRIMED PINE MOULDING



COLONIAL CASING 1 1/16" x 2-1/4"	
LENGTH	SKU NO.
14'	106700-14



COLONIAL BASE 3-1/4" x 7/16"	
LENGTH	SKU NO.
10'	106703-10
16'	106703-16

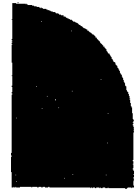

BASE SHOE 7/16" x 3/4"	
LENGTH	SKU NO.
16'	106710-16



COLONIAL CHAIR RAIL 1 1/16" x 2-5/8"	
LENGTH	SKU NO.
16'	106725-16



COLONIAL BASE 4-1/4" X 9/16"	
LENGTH	SKU NO.
14'	106705-14
16'	106705-16



RANCH BASE 7/16" X 3-1/4"	
LENGTH	SKU NO.
16'	106720-16



CROWN 5/8" x 3-5/8"	
LENGTH	SKU NO.
16'	106713-16

OAK MOULDING



RANCH CASING 5/8" X 2-1/4" 327 ROL	
LENGTH PIECE	SKU
7'	102515-07
8'	102515-08
10'	102515-10
12'	102515-12
16'	102515-16
-	-



COLONIAL CASING 1/2" x 2-1/4" 356 ROL	
LENGTH PIECE	SKU
7'	102520-07
8'	102520-08
9'	102520-09
12'	102520-12
16'	102520-16
-	-



CORNER GUARD 1" x 1" 205 ROL	
LENGTH PIECE	SKU
10'	102547-10
12'	102547-12
-	-
-	-
-	-
-	-



COLONIAL BASE 1/2" X 3-1/4" 623 ROL	
LENGTH PIECE	SKU
8'	102530-08
9'	102530-09
10'	102530-10
11'	102530-11
14'	102530-14
16'	102530-16



QUARTER ROUND 3/4" x 3/4" 105 ROL	
LENGTH PIECE	SKU
10'	102500-10
11'	102500-11
12'	102500-12
13'	102500-13
16'	102500-16
-	-



RANCH BASE 1/2" x 3-1/4" 713 ROL	
LENGTH PIECE	SKU
8'	102525-08
10'	102525-10
14'	102525-14
15'	102525-15
16'	102525-16
-	-



BASE SHOE 7/16" x 3/4" 127 ROL	
LENGTH PIECE	SKU
8'	102535-08
10'	102535-10
16'	102535-16
-	-
-	-
-	-



SCREEN MOLD 1/4" x 3/4" 144 ROL	
LENGTH PIECE	SKU
7'	102545-07
12'	102545-12
16'	102545-16
-	-
-	-
-	-



ROUND EDGE STOP 3/8" x 1-1/8" 877 ROL	
LENGTH PIECE	SKU
8'	102510-08
9'	102510-09
10'	102510-10
12'	102510-12
13'	102510-13
-	-



COLONIAL CHAIR RAIL 1 1/16" x 2-5/8" 390 ROL	
LENGTH PIECE	SKU
8'	102505-08
13'	102505-13
14'	102505-14
16'	102505-16
-	-
-	-



COLONIAL CORNER BEAD 1-1/16" x 1-1/16" 202 ROL	
LENGTH PIECE	SKU
16'	101634-16
-	-
-	-
-	-
-	-
-	-



CROWN 9/16" x 3-5/8" 49 ROL	
LENGTH PIECE	SKU
10'	102540-10
12'	102540-12
14'	102540-14
16'	102540-16
-	-
-	-

**PRE-MITRE TRIM SETS
 For Pre Hung 3/0x 6/8"**

(2 Sides - 1 Header = each set)

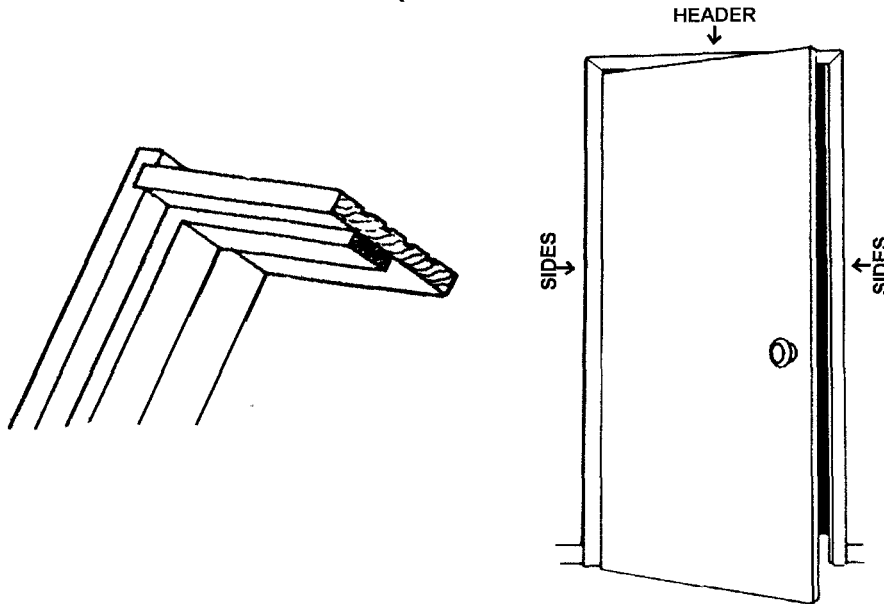

104195	1/2" x 2 1/4" Luan Ranch Casing
104210	11/16" x 2 1/4" Pine Ranch Casing
104220	1/2" x 2 1/4" Oak Ranch Casing
104230	1/2" x 2 1/4" Poplar Ranch Casing
104200	1/2" x 2 1/4" Primed Colonial Casing
104205	9/16" x 2 1/4" Birch Colonial Casing
104215	11/16" x 2 1/4" Pine Colonial Casing
104225	1/2" x 2 1/4" Oak Colonial Casing
104235	1/2" x 2 1/4" Poplar Colonial Casing















RANCH CASING



COLONIAL CASING

HARDWOOD DOWELS



COLORS	white	Black	Blue	Yellow	Orange	Green	Purple	Gray	Red	Brown	Natural	Lt.Blue	Lt Green
	 1/8	 3/16	 1/4	 5/16	 3/8	 7/16	 1/2	 5/8	 3/4	 7/8	 1	 1 1/8	 1 1/4

36" DOWELS

SKU	Size	Item Number	Carton Pack	Color
802526	1/8"	2905	100	WHITE
802529	3/16"	2910	100	BLACK
802532	1/4"	2915	100	BLUE
802535	5/16"	2920	100	YELLOW
802538	3/8"	2925	100	ORANGE
802541	7/16"	2930	50	GREEN
802544	1/2"	2935	50	PURPLE
802547	5/8"	2940	25	GRAY
802550	3/4"	2945	25	RED
802553	7/8"	2950	15	BROWN
802556	1"	2955	10	NATURAL
802559	1-1/8"	2958	10	LIGHT BLUE
802562	1-1/4"	2960	10	LIGHT GREEN

48" DOWELS

802565	1/8"	3005	100	WHITE
802568	3/16"	3010	100	BLACK
802571	1/4"	3015	100	BLUE
802574	5/16"	3020	100	YELLOW
802577	3/8"	3025	100	ORANGE
802580	7/16"	3030	50	GREEN
802583	1/2"	3035	50	PURPLE
802586	5/8"	3040	25	GRAY
802589	3/4"	3045	25	RED
802592	7/8"	3050	15	BROWN
802595	1"	3055	10	NATURAL
802598	1-1/8"	3058	10	LIGHT BLUE
802601	1-1/4"	3060	10	LIGHT GREEN

VINYL COVE BASE

".080"



RIBBED AND KNURLED BACK
For good adhesion.

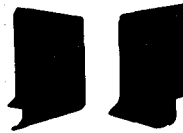

OUTSIDE CORNERS AVAILABLE.

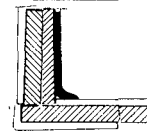

SET-ON BASE
For use with hard surface floors.

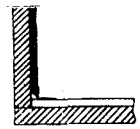

STRAIGHT BASE
For use with carpets.

Made of homogeneous vinyl in a complete range of contemporary colors. Nafco Vinyl Cove Base has a superior finish to assure an attractive juncture of floors and walls. Its flexibility not only makes installation fast and economical, but it helps conceal floor and wall irregularities.

Flexco Adhesives must be used with this.

GAUGE: 1/8" and .080" LENGTHS: 48" lengths and 120' rolls.
 Available in 2 1/2", 4" & 6" heights; set-on & straight.

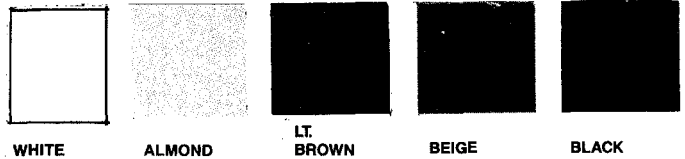

SKU NO.	Mfg. No.	Color	Size	Item
103485	CB-10	Gloss White	2 1/2" x 4'	Cove Base
103506	CB-10	Gloss White	4" x 4'	Cove Base
103533	CB-10	Gloss White	2 1/2"	Corner
103554	CB-10	Gloss White	4"	Corner
103712	CB-10	White	4" x 120'	Cove Base
103509	CB-14	Almond	4" x 4'	Cove Base
103557	CB-14	Almond	4"	Corner
103497	CB-35	Gloss Nubian Brown	4" x 4'	Cove Base
103709	CB-35	Nubian Brown	4" x 120'	Toeless
103704	CB-35	Nubian Brown	4" x 120'	Cove Base
103545	CB-35	Gloss Nubian Brown	4"	Corner
103479	CB-37	Gloss Brown	2 1/2" x 4'	Cove Base

SKU NO.	Mfg. No.	Color	Size	Item
103500	CB-37	Gloss Brown	4" x 4'	Cove Base
103527	CB-37	Gloss Brown	2 1/2"	Corner
103548	CB-37	Gloss Brown	4"	Corner
103514	CB-63	Gloss Ninja Gray	4" x 4'	Cove Base
103512	CB-65	Gloss Light Gray	4" x 4'	Cove Base
103560	CB-65	Gloss Light Gray	4"	Corner
103503	CB-70	Gloss Beige	4" x 4'	Cove Base
103551	CB-70	Gloss Beige	4"	Corner
103703	CB-80	Black	4" x 120'	Cove Base
103473	CB-80	Gloss Black	2 1/2" x 4'	Cove Base
103494	CB-80	Gloss Black	4" x 4'	Cove Base
103515	CB-80	Gloss Black	6" x 4'	Cove Base
103521	CB-80	Gloss Black	2 1/2"	Corner
103542	CB-80	Gloss Black	4"	Corner
103563	CB-80	Gloss Black	6"	Corner
103657	CB-80	Gloss Black	4" x 4'	Toeless Base
103700	CB080	Black	4" x 120'	Toeless Base

WE SPECIAL ORDER ANY VINYL TILE OR COVE BASE - ALL ITEMS SHOWN ARE STOCKED BUT WE CAN GET WHAT YOU NEED. JUST ASK

VINYL COMPOSITION FLOOR TILE

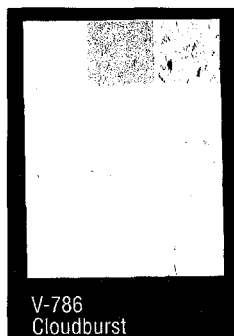

Cloudburst

V-786
Cloudburst

SKU	SIZE	MFG #
100786	12" X 12"	V-786

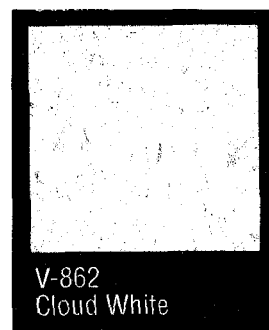

Cloud White

V-862
Cloud White

SKU	SIZE	MFG #
100782	12" X 12"	V-862

HOUSE WRAP & FOIL INSULATIONS

TYPE	SKU NO.	PART NO.	R-VALUE	WIDTH	LENGTH	SQ. FT/ROLL
REFLECTIX INSULATION Reflectix is a 5/16-inch thick reflective insulation which comes in rolls and is made up of seven layers. Two outer layers of aluminum foil reflect most of the heat which heats them. Each layer of foil is bonded to a layer of tough polyethylene for strength. Two inner layers of bubblepack resist heat flow, while a center layer of polyethylene gives Reflectix additional strength.	102487	FT210	Foil Seal tape	2"	30'	5'
	102474	BP24025	10 prox.	24"	25'	50'
	102470	BP48025	10 prox.	48"	25'	100'
	102467	BP48050	10 prox.	48"	50'	200'
REFLECTIX STAPLE TAB INSULATION Copy same as above	102478	ST16025	10 prox.	16"	25'	33'
REFLECTIS PIPE WRAP Copy same as above	593665	LPW6025	10 prox.	6"	25'	12.5'
	102485	RDW12025	10 prox.	12"	25'	25'
REFLECTIX PIPE WRAP Copy same as above	102482	PPW225	10 prox.	2"	25'	4.17'
88 REFLECTIVE PAPER	102490	01-107	N.A.			
PERM-VENT INSULATION VENT CONTROL	102462	for 16" O.C. & 24" O.C.	N.A.	11 3/4"	48'	
TYPAR HOUSE WRAP Typar House Wrap is a spun bonded polypropylene fabric that will reduce air infiltration and exfiltration by providing an airtight envelope around a house. It also inhibits air movement in wall cavities by covering construction gaps. Typar is also breathable to allow water vapor to escape.	102466			3'	111'	333'
	102484			9'	100'	900'
REFLECTIX WATER HEATER JACKET KIT Fits most water heaters. Save 97% of radiant heat loss.	102493	WHK-1	10 prox.			

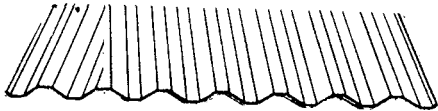

CORRUGATED PANELS AND ACCESSORIES

STEEL

High strength lightweight corrugated form is suitable as a base for structural concrete, lightweight aggregate or roofing applications. Corrugations are 2 1/2" on center and panels are 26" wide 29 gauge galvanized steel.

SKU	LENGTH	WIDTH	GAUGE
103155	96"	26"	29
103165	144"	26"	29

FIBER GLASS

Opaque fiberglass reinforced plastic panels are manufactured with thermosetting styrenated and acrylated polyester resins. Panels are 26" wide and weigh 8 ounces per square foot (.060" thick). Applications include roofing, fencing, partition and canopies where light transmission is desirable. Panels are white in color and allow 50% light transmission.

SKU	LENGTH	WIDTH	WEIGHT/SQ. FT.
103078	96"	26"	8 oz.
103082	144"	26"	8 oz.

ACCESSORIES

Closure Strips

Strips are made of clear grade redwood

SKU	TYPE	LENGTH	APPLICATION
103170	Horizontal	96"	To close opening across corrugation
103175	Verticle	96"	To close opening alone corrugation

EXTERIOR PANELS & COVERING

SKU NO.	TYPE	DESCRIPTION
58T111	T1 - 11	5/8" Fir 4' x 8' sheets
408STUCW	Stucco Siding	7/16" Hardboard 4' x 8' White Stucco
103270	Lap Siding	1/2" x 12" x 16" Primed Hardboard Siding



FIBERGLASS INSULATION

TYPE	SKU NO.	R-VALUE	THICKNESS	WIDTH	SQ. FT/PKG
UNFACED INSULATION These flexible fibre glass batts have no facing and may be used in conjunction with a separate vapor barrier when vapor control is required. They are designed for friction-fit installation between studs or can be attached to non-framed surfaces.	102355	11	3-1/2"	15"	88 sq.ft.
	102358	11	3-1/2"	16"	94 sq.ft.
	102361	11	3-1/2"	24"	141 sq. ft.
	102365	19	6"	15"	49 sq. ft.
	102369	19	6"	24"	128 sq. ft.
	102370	19	6"	23"	75 sq. ft.
	102372	30	8-1/2"	15"	60 sq. ft.
	102373	30	9-1/2"	24"	80 sq. ft.
KRAFT-FACED A glass fiber insulation with a strong asphalt-coated kraft paper facing on one side with stapling flanges available on wood framing widths only. The kraft facing has a perm rating of 1.	102375	11	3-1/2"	15"	88 sq. ft.
	102380	11	3-1/2"	23"	135 sq. ft.
	102381	13	3-5/8"	15"	107 sq. ft.
	102385	19	6"	15"	49 sq. ft.
	102390	19	6"	23"	75 sq. ft.
	102389	30C	8-1/2"	23"	92 sq. ft.
	102394	30C	8-1/2"	15"	60 sq. ft.
	102393	30	9"	16"	53 sq. ft.
	102374	30	9-1/2"	24"	80 sq. ft.
FOIL FACED A glass fiber insulation with an aluminum foil kraft facing on one side with stapling flanges at edges available on wood framing widths only. The foil facing has a perm rating of 0.5.	102395	11	3-1/2"	15"	88 sq. ft.
	102400	11	3-1/2"	23"	135 sq. ft.
	102402	11	3-1/2"	24"	141 sq. ft.
	102405	19	6"	15"	49 sq. ft.
	102410	19	6"	23"	75 sq. ft.
	102409	19	6-1/2"	24"	128 sq. ft.
THERMAFIBER Safing insulation to form the finest fire stop system in the industry. These high melt point (over 2,000°F) commercial insulation systems provide an effective 3-hour fire barrier where the floor slab edge meets the curtain wall spandrel panel. This confines flames to the floor of origin for hours. Keeps fires from spreading to floors above.	102414	R16	4"	24"	24 sq. ft.
VERMICULITE Water repellent, free flowing insulation that can be poured into hollow cavities that require insulating.	102465	2.4/in	N.A.	N.A.	3 cu. sq. ft/bag
SILL SEALER	102480	3	3/4"	6"	50 sq. ft.
FOAM SILL SEALER	103190	N/A	5-1/2" X 40'		20 sq. ft.

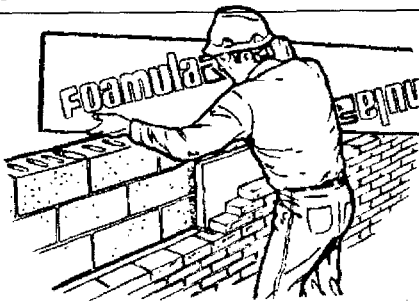

FOAMBOARD INSULATION PRODUCTS

Foamboard insulation provides higher R-values and performs as superior insulation compared to conventional board products. Foamboard insulation may be used in a variety of residential, commercial and agricultural building applications.

TYPE	SKU. NO.	R-VALUE	THICKNESS	WIDTH	LENGTH
EXTRUDED POLYSTYRENE BOARD uses an extrusion process to make a tough, dense board. Extruded board has very low water absorption properties which make a highly suitable for below ground application. Dow Chemical manufacturers an extruded polystyrene product called Styrofoam®	102420	5.4	1"	24"	96"
	102425	8.1	1 1/2"	24"	96"
	102430	10.8	2"	24"	96"
BLOCK MOLDED EXPANDED POLYSTYRENE BOARD (EPS) is manufactured by molding polystyrene beads into a large block, then cutting the block to the desired thickness using hot wires.	102443	3.1	3/4"	14 1/2"	96"
	102435	3.1	3/4"	24"	96"
	102440	3.1	3/4"	48"	96"
	102445	4.2	1"	24"	96"
	102450	4.2	1"	48"	96"
	102455	6.3	1 1/2"	24"	96"
	102460	8.3	2"	24"	96"

AMSTONE®

roof coating

Fibred Roof Coating is a heavy duty fibrated roof coating of brush consistency. It is used to rejuvenate worn built-up, metal, composition, or concrete roofs through resaturation and coating. It protects the underlying roofing felts from becoming brittle and cracking.



SKU NO.	MFG. NO.	SIZE
102595	595	GALLON
102600	546	5 GALLON

Wet Surface Roof Cement

Wet Surface Roof Cement is an all weather asphalt plastic cement that has been chemically fortified so that it will "wet out" and bond to water covered or damp surfaces, as well as dry surfaces. It can be used to patch splits and cracks less than 1/4" wide in gravel, mineral surfaced cap sheets and smooth surface asphalt roofs. It can also be used for the repair of flashings around chimneys, vent pipes and gravel guards, or cracks in concrete.



SKU NO.	MFG. NO.	SIZE
102585	554	GALLON
102584	555	QUART
102590	553	5 GALLON
102587	570	10 OUNCE



AMSTONE®

Roof Coating

AMSTONE® Fibrated Roof Coating is recommended for sealing and rejuvenating of built-up and old composition roofs. Restores protective properties destroyed by exposure.



SKU No.	Mfg. No	Size
102604	549	GALLON
102805	548	5 GALLON

AMSTONE



LAP CEMENT/BLIND NAIL FIBRATED

A semi-mastic liquid adhesive for applying saturated felt and roll roofing materials. Quick-setting, cold applied for applications where hot-mopped installations are not practical. May also be used for blind nailing to eliminate potential nail hole leaks.

SKU NO.	MFG. NO.	SIZE
102583	0557	1-Gallon

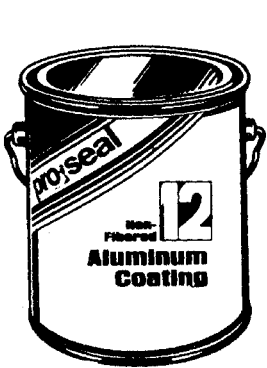

Non-Fibred Aluminum Coating

Pro-Seal #12 Aluminum Roof Coating is a quality, reflective, non-fibred coating with a myriad of brilliant aluminum flakes suspended in a tough and flexible vehicle of selected asphalt and solvent. Upon application, the bright aluminum flakes leaf to the surface to form a radiant metal shield. Beautifies and reflectively insulates against the sun's destructive rays and protects against winter moisture. It may be applied by spray, brush or roller.

SKU NO.	Mfg. No.	Size
102620	733204	GALLON
102622	733212	5 GALLON

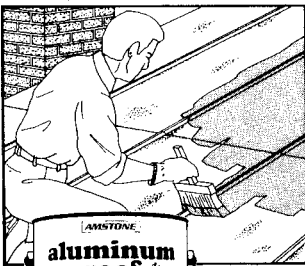

AMSTONE®

Aluminum Roof Coating

AMSTONE® Premium Aluminum Roof Coating provides a highly reflective and durable protective coating on metal, built-up roofing, modified bitumen, cold process and other roof surfaces, where heat-reflective waterproof coatings are required.



SKU No.	Mfg. No.	SIZE
102610	0560	Gallon
102615	0559	5 Gallon

GAF - 25 year

Classic is a high performance glass fiber shingle that catches the eye of today's quality and value conscious customer.

Because *Classic* shingles incorporate a glass fiber "base mat," they resist blistering, curling, buckling and they won't absorb moisture. And because they contain more weathering-grade asphalt than comparable organic shingles, they provide superior protection against harsh weather.

Classic shingles carry Underwriters Laboratories Class A Fire Rating as well as the U.L. Wind Resistance Rating.

Product Description

- 12" wide x 36" long
- Three tabs per shingle
- Three bundles (80 shingles) per square

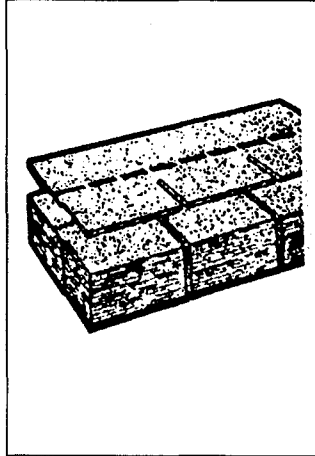

COLOR	SKU
White	102503
Black	102505

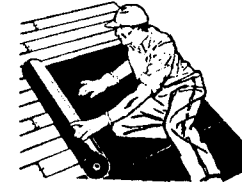

Mineral Surfaced Roll Roofing

This glass fiber based roll roofing incorporates modern technology in a popular roofing product. The strong glass fiber mat assures that it won't absorb moisture. This makes it lay flatter, last longer and resist weather better. Owens-Corning Fiberglas mineral surfaced roll roofing comes in two popular colors. It's attractive. It's economical. It's the really durable solution for the low sloped roof.

COLOR	SKU
White	102515
Black	102510

Ice & Water Shield™

Product Description

The Ice & Water Shield System consists of a primer and a membrane. They are economical and cold-applied with no special equipment necessary. Ice & Water Shield Membrane is composed of two waterproofing materials—rubberized asphalt and polyethylene. The rubberized asphalt surface is backed with a release paper that maintains the adhesive quality of the rubberized asphalt. During application the release paper is removed allowing the rubberized asphalt to bond tightly to the primed roof deck. Ice & Water Shield Membrane is supplied in rolls 36" wide and 75' long. It is self-adhesive and can be applied in temperatures down to 40°F.

SKU - 102562

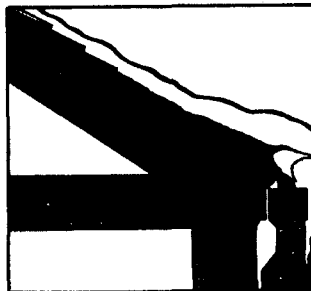

Ice & Water Shield waterproofs the roof deck preventing melted snow from leaking into structure. The interior and its contents are protected.

19" Selvege Mineral Surfaced Roll Roofing for use on roofs with minimum slope of 1" in 12"

Specifications

- 36" wide by 36' long
- 108 square feet per roll
- Covers ½ square per roll

COLOR	SKU
Black	102530

ASPHALT FELT

Asphalt felt underlayment consists of dry organic felt impregnated with asphalt saturant

TYPE	SKU
15 LB	102550
30 LB	102560

ROOFING MEMBRANE

Roofing membrane consists of a cotton fabric gauze impregnated with asphalt saturant used to prevent crack reformation on roofs.

SIZE	SKU
4" x 150'	102570
6" x 150'	102575
12" x 150'	102580

VYCOR PLUS
6" X 75' Flashing
SKU - 102563

RED ROSIN SHEATING

Red Rosin Roll, sheating is a heavy, paper in roll form that weighs approximately 2.7 LBS per 100 Sq. Ft. It must be applied over wood board decks before applying base felt. Can also be used as a low cost disposable floor runner during construction or move-in phases

SIZE	SKU
3' x 167'	102535

ICE MELT

*For deliveries that require hand unloading, use SKU No. SALTDEL

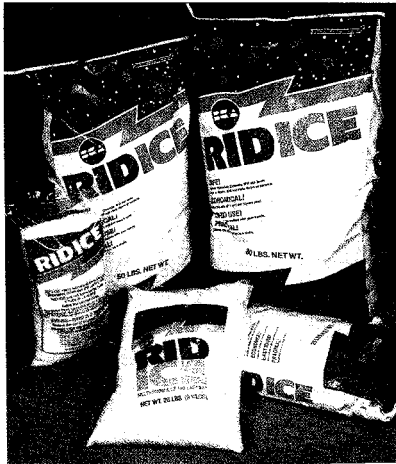

ICE MELT

*For deliveries that require hand unloading, use SKU No. SALTDEL

SKU NO.	POTASSIUM CHLORIDE
698142	12 LB. JUG
10PC	10 LB. BAG PELLETS
20PC	20 LB. BAG PELLETS
50PC	50 LB. BAG PELLETS
80PC	80 LB. BAG PELLETS
100PC	100 LB. DRUM

-15°

Melts Ice and Snow down to -15° F and is safe for sidewalks and lawns.



SNO MELT INSTANT ICE MELTER

SKU NO.	CALCIUM CHLORIDE
25CCF	25 LB. BAG FLAKES
50CCP	50 LB. BAG PELLETS

-30°

Melts Ice and Snow down to -30° F and is safe for sidewalks or grass.



ICE MELT

SKU NO.	SODIUM CHLORIDE
80RS	80 LBS. ROAD ROCK SALT

Melts Ice and Snow down to -5° F

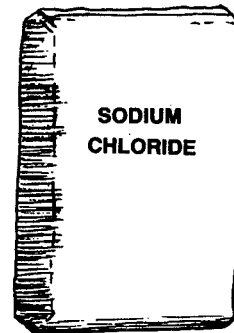

WATER CONDITIONING

SKU NO.	SODIUM CHLORIDE
80WCS	80 LBS. WATER CONDITIONING ROCK SALT
80SP	80 LBS. WATER CONDITIONING SALT PELLETS
50BS	50 LBS. WATER CONDITIONING SALT BLOCK
50WCS	50 LBS. WATER CONDITIONING ROCK SALT
50SS	50 LBS. WATER CONDITIONING SOLAR SALT

Visit our lawn and garden center for quality spreaders. You may purchase or rent one of our fine spreaders.

Sand and Stone Material Bulk Load

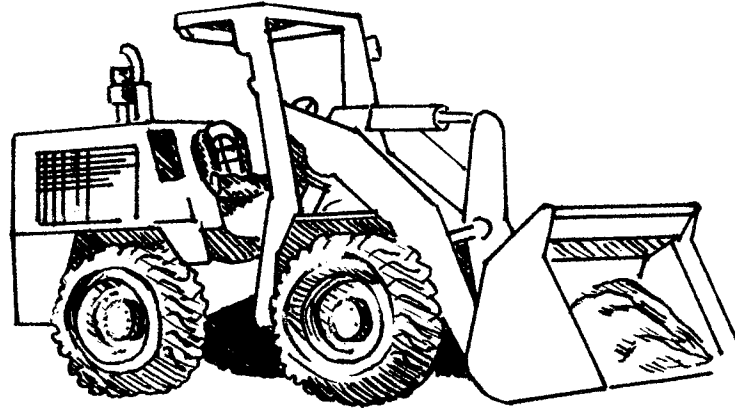

SKU	DESCRIPTION	WT/CU YD
SAND 1	Fine sand used as play sand and as an aggregate in general purpose mortar	2850#/yd
SAND 2	Coarse sand used as a land fill and as an aggregator in concrete	2850#/yd
GRAVEL P	1/4 - 3/8" size river bed gravel suitable for back filling, decorative ground cover and weed control	2700#/yd
GRAVEL 6	1/4 - 3/4" size river bed gravel suitable for use as ground cover or drainage field or as an aggregate in concrete	2650#/yd
GRAVEL 8	3/4 - 1" size river bed gravel suitable for use as ground cover or drainage field	2600#/yd
STONE 2	3/4" crushed size limestone (white) suitable for use in drainage fields or as an aggregate in concrete. (Irma Stone)	2700#/yd
STONE 14	A mixture of 3/4" and fine crush limestone that will pack hard if compressed suitable as a sub base for paving brick applications and as driveway/parking lot base	2800#/yd
All Bulk Material is also sold in less than cubic yard sizes:		
301320	5 Gallon	
301325	Bushel	
301335	20 Gallon Garbage Can	
301340	30 Gallon Garbage Can	
301345	Wheel Barrow	
106552	14" x 26" Empty Woven Plastic Sand Bag	

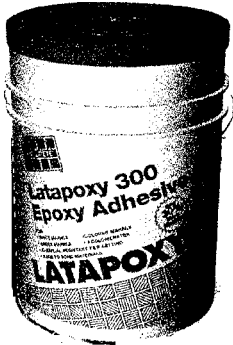

SKU	Mfg. No.	SIZE
375850	LATSP30	Full Unit (Appr. 4 gal)
375835	LATADHELATA	Half Unit (Appr. 2 gal)



Liquid Crak-Seal

Seals leaky inside cracks from outside wall.

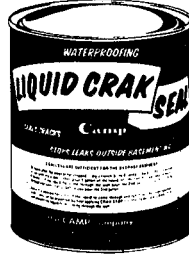

SKU NO. 301155 MFG. NO. 123
AVAILABLE IN 1-GALLON CANS ONLY
2 GALLONS ARE SUFFICIENT FOR THE AVERAGE
BASEMENT CRACK

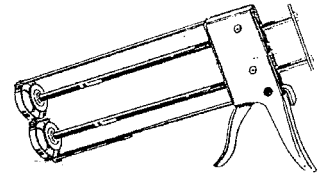

Dual caulking/injection gun available to purchase or rent. Please ask for more information.

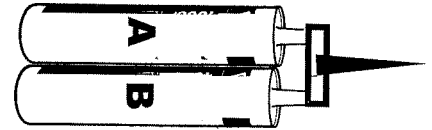

U-MIX TUBE INJECTION URETHANE (INSTANT ACTION)

No mixing mess, needs no premixing, no waste. Inject with a double barrel caulking gun.

SKU No.	Size A&B
301552	10 oz. ea.

EPOXY PATCHING & RESURFACING CEMENT/GROUT

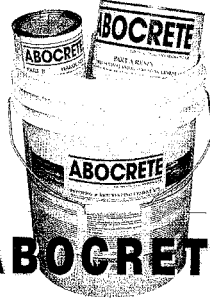

ABOCRETE™

SKU	SIZE
375840	1.3 gal Kit
375845	5 gal kit

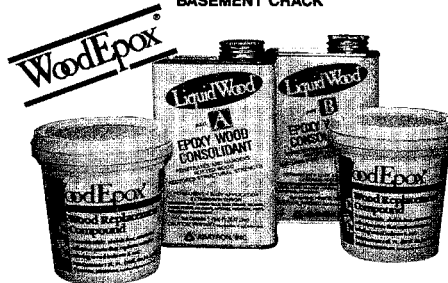

WoodEpoxy is a light weight, epoxy putty system consisting of 2 components: Resin paste (A) and hardener paste (B). When A & B are mixed, the blend hardens within 1 - 2 hours into a lighter-than-water non shrinking tough adhesive mass with high dimensional stability, chemical and water resistance.

SKU	SIZE
375847	24oz KIT

PRO-POXY 300 GEL SURFACE EPOXY

General purpose non-sag epoxy adhesive binder. A multi-purpose, 2 component, solvent-free, moisture insensitive structural epoxy adhesive with high-modulus, high-strength. Use with concrete, masonry, metals, wood and most structural materials. Easy to mix, fast setting. Also use with U-MIX for surface patching cracks.

SKU No.	Size
301553	Gal.
301554	20 oz. Dual Cartridge

Thompson's WATER SEAL® BRAND
Penetrates so water won't.

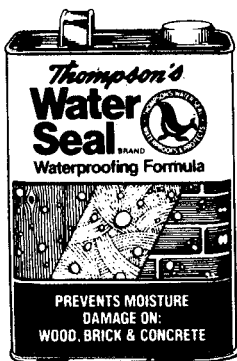

Waterproofs to help prevent moisture damage on wood, brick and concrete.

SKU NO.	MFG. NO.	SIZE
300503	10100	12 Oz.
300504	10104	Quart
300505	10101	Gallon
300115	10105	5-Gallon

VOLCLAY-GPG30

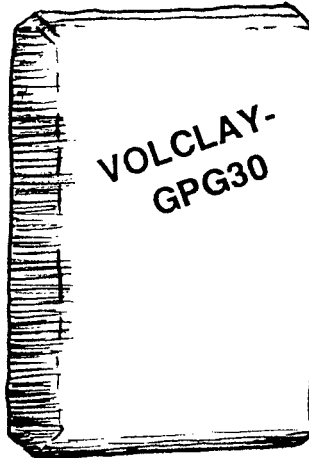

Granular sodium bentonite, sizes between 20 & 70 mesh, need for rapid dispersion in water specially contractors for remedial water proofing.

SKU NO.	Mfg No.	Size
300025	GPG-30/3	50 lb.



GENERAL PURPOSE EPOXY ADHESIVE BINDER

Pressure-injection of cracks in structural concrete, masonry, wood, grouting bolts, dowels, pins super slow viscosity. Excellent resistance for flooring systems.

SKU No.	Mfg. No.	Size
301550	B50	Gal



DAP Stucco Patch

Fills small cracks and holes in stucco.
 For use in doors or outdoors.

SKU NO.	MFG NO.	SIZE
455039	10506	Gallon

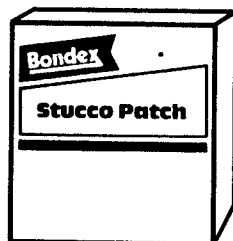

Stucco Patch

■ A powder mix for patching interior or exterior stucco above or below ground

SKU NO.	MFG. NO.	SIZE
301260	60515	15 LB

DURABOND™ **USG**



Wallboard joint compound for smooth high quality finishing of gypsum panel

SKU NO.	MFG. NO.	SIZE
357418	10100	Quart

Tile Grout



For use around tubs, sinks, floors, countertops and showers

SKU NO.	MFG NO.	SIZE
301255	50005	5 LB.

WHITE WALL GROUT

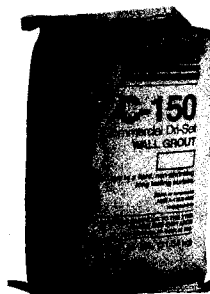

SKU NO.	MFG. NO.	SIZE
303520	C-150	5LB.
303525	C-150	25LB.

SET CEMENT

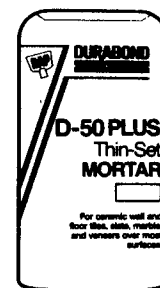

SKU NO.	MFG. NO.	COLOR	SIZE
301217	D-50	Gray	50LB.
301223	D-50	White	50LB.

PLUS 5
 is America's Leading Field Marker

The 5 Plusses are:
 A Bright, Whiter Line
 Easy to Apply
 Good for Turf
 Economical
 Harmless to Skin & Clothing
 ... And it's Officially Approved!

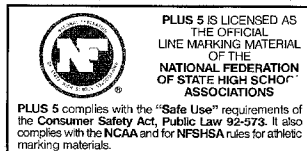

SKU NO.	SIZE
301771	50 lb

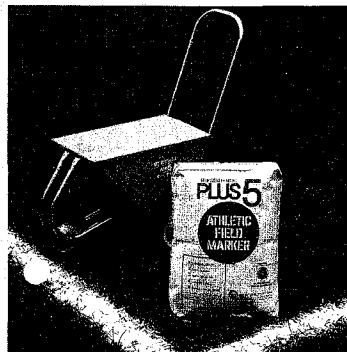

LATEX ADDITIVE FOR THINSET

SKU NO.	MFG. NO.	SIZE
301224	D-L16	Gallon

1

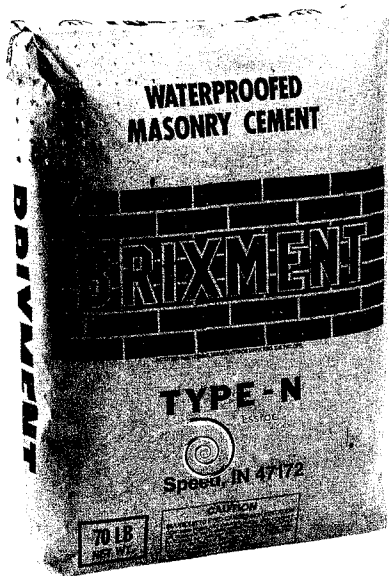

Type N
70 lbs.

**BRIXMENT
Masonry Cement
Type N**

Masonry cement is a factory-prepared combination of materials so that, when mixed with water and the proper amount of well-graded sand, the mortar has a good balance of desirable properties.

- sand carrying capacity
- high degree of workability
- adequate strength
- low volume change
- intimate bond
- reduced efflorescence
- resistance to freeze-thaw cycles

A bag of BRIXMENT Type N when mixed with 3 cubic feet of well-graded sand produces a mortar that is recommended for all general masonry work—veneer, curtain and partition walls, chimneys and backup construction.

SKU NO.	Color
300010	Gray
300012	White

**Smith's Mortar
Colors Stocked
As Concentrates
Color Charts
Are Available**

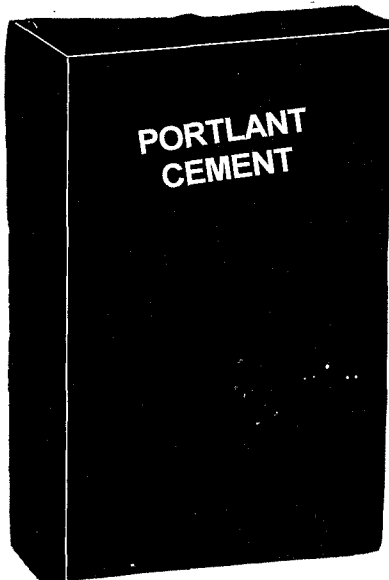

Portland Cements

A bag of Portland Cement type I or III when mixed with 3 cubic feet of stone and 2 cubic feet of coarse sand will produce concrete that is suitable for general purpose slab construction.

Type I is a general purpose portland cement suitable for all uses where the special properties of other types are not required.

SKU NO.	Color
300000	Gray
300005	White

Type III is a high-early strength portland cement that provides high strengths at an early period.

SKU NO.	Color
300008	Gray

MORTA-LOK LIME

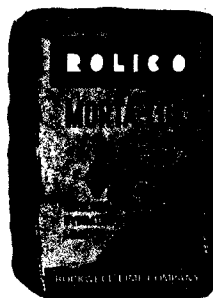

There is a great flexibility in specifying mixture of type S hydrated lime and portland cement for mortar, gives a good bond, and elasticity under structural stress.

SKU NO.	SIZE
300015	50LB.

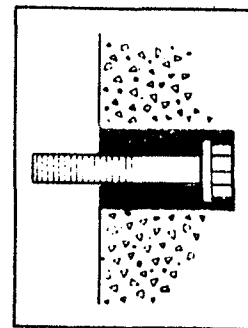

**POR-ROK®
Anchoring Cement**

Product Presentation

Por-Rok Anchoring Cement is a non-shrink hydraulic controlled expansion cement in a ready to use preparation. Water is added at the job site to create a pourable, yet durable, anchoring, patching or gouting compound.

POR-ROK sets in 15-20 minutes. Attains 5,090 psi compression strength after 60 minutes.

Pourable

When mixed according to directions, **POR-ROK** becomes pourable and will seep into pores and crevices.

SKU NO.	Size
301661	1 lb.
301662	5 lb.
301666	10 lb.
301667	25 lb.
301668	50 lb.



Blasting Sand

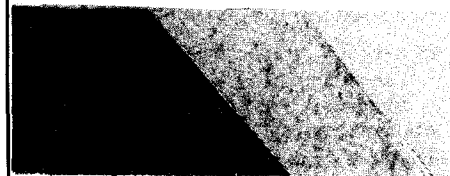

All sands are cleaned and there are no chunks to clog your nozzles.

SKU NO.	MFG. NO.	TYPE	SIZE
300020	2.4	Silica Sand	100LB.
301020	1240	Black Beauty	100LB.
301025	.45.55MM	Pool Filter	50LB.

Plasters



STRUCTO-LITE Gypsum Plaster contains mill-mixed perlite aggregate, and requires only addition of water at jobsite. Weighs less than half as much as sanded basecoats and provides greater insulation value with a "K" factor of 1.74.

SKU NO. 300050



Red Top Wood Fiber Plaster develops higher strengths than other conventional gypsum plasters. Recommended as scratch coat over metal lath. For machine application or use over masonry bases or other applications, add 1 cu. ft. sand per 100 lb. plaster. In 50-lb. bags.

SKU NO. 300055

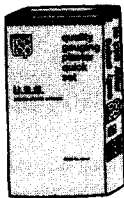

Red Top Gauging Plaster is usually darker in color than CHAMPION and STAR gauging. Blends easily with lime putty for durable, smooth-trowel or sand-float finishes in residential construction. Offers high strength, hardness and abrasion resistance. Easily decorated. Apply over gypsum basecoat.

Quick Set, 30-40 min.; **Slow Set**, 50-70 min. Meets ASTM C28. In 100-lb. bags.

SKU NO.	TYPE
300065	Quick-Set
300060	Slo-Set



Ivory and Snowdrift Finish Limes are fine, white, double-hydrate products for superior finishing over basecoat plasters. Blend with gauging plasters and water into a smooth-troweling, highly workable finish. Autoclaved hydration (over 92%) speeds mixing and virtually eliminates surface defects caused by delayed hydration. Meets ASTM C206, Type S. In 50-lb. bags.

SKU NO. 300045

Plaster Of Paris

■ For carts, molds and for many shapes.



SKU NO.	MFG NO.	SIZE
301230	53001	1 LB.
301235	53002	2½ LB.
301240	53005	5 LB.
301245	53015	15 LB.
301250	53025	25 LB.



DIAMOND Interior Finish Plaster gives a strong, hard surface for commercial or residential construction. Hand-applied ¼" thick over IMPERIAL Base or over a bonding agent on monolithic concrete. Also suitable in a two-coat system over IMPERIAL Basecoat or a sanded gypsum basecoat. High coverage, fast application provides cost savings where the extra hardness of IMPERIAL Plaster is not required. White; can be left undecorated for float finishing or skip troweling. However, decorating should be specified and may be eliminated if finished plaster is acceptable. Unaggregated for smooth or skip-trowel finish; may be job-aggregated for float or other texture. In 50-lb. bags.

SKU NO. 300071

USG Moulding Plaster is used for specialized work such as ornamental trim or cornices. The plaster grain is very fine, ideal for sharp detail when used neat for cast work. Controlled set provides uniform workability. For running cornice work, add a small amount of lime putty to add plasticity and act as lubricant for the template. Provides approx. 1.5 cu. ft. per 100 lbs. Complies with ASTM C28. In 50-lb. bags

SKU NO. 300068



Red Top Retarder and Red Top Accelerator are available for use with plaster when required by job or climate conditions. When used in excess, setting and drying problems can arise. Use of too much retarder can weaken plaster finish. In 1½-lb. package

SKU NO.	TYPE
300074	Accelerator
300076	Retarded



Patching Plaster

- For economical repair of plaster walls and ceilings
- Non-shrinking and sandable

SKU NO.	MFG. NO.	SIZE
301220	52002	2.2 LB.
301225	52005	4.4 LB.

WE ARE PLEASED TO SPECIAL ORDER ITEMS THAT ARE NOT ALREADY IN OUR INVENTORY

1

BLACKTOP 'N BOND® ASPHALT REPAIR MIX

A pre-blended, semi-flexible patching material for thin section repairs to asphalt surfaces. Made with finely graded aggregate, portland cement and specialty polymers, it may be applied in thicknesses from one inch down to a feather edge. Cures to the color of blacktop. Just add water.

SKU NO.	MFG. NO.	SIZE
301635	0685	40 lb. Pail
301636	0686	10 lb. tub

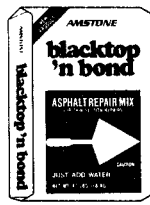

SAKRETE® BLACKTOP MIX & PREMIUM MIX

A blend of steam cured asphalt and graded aggregates. Can be used to build or repair any blacktop area. Simply place right as it comes from the bag in 1" layers and tamp firmly. Specifically designed for pothole applications.

SKU NO.	MFG. NO.	SIZE
301695	0071	60 lb. bag
301768	Premium	25lb pail



POUR 'N FILL™ CRACK FILLER

Seals cracks in concrete and blacktop. Moisture seeping through cracks can freeze and thaw causing even greater deterioration. Prevent it with POUR 'N FILL. For cracks up to 1/2" wide.

SKU NO.	MFG. NO.	SIZE
102639	0104	1 Gal.



SMOOTH 'R FILL® MASTIC PATCH

Heavy duty mastic filler for blacktop repair. Fills dips, scuffs and cracks. Resists gasoline and oil. Apply with trowel from 1/8 to 1/4 inch thick. Dries to a jet black color.

SKU NO.	MFG. NO.	SIZE
102641	0174	1 Gal.



SAKRETE® TAR SEALER

A tar pitch emulsion sealer with an easy stir formula designed to beautify blacktop surfaces while protecting the area from gasoline and oil drippings. Gives a jet black coating with a quick-dry additive. Resists weather and wear.

SKU NO.	MFG. NO.	SIZE
102630	0094	5 Gal.

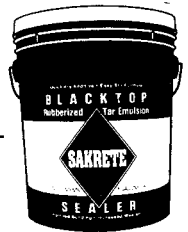

SAKRETE® GILSONITE ASPHALT SEALER

An asphalt base product, which cures to a hard weather resistant, protective finish. SAKRETE® Asphalt Sealer improves the appearance of older paved areas and retards the natural aging process of blacktop pavements. Recommended for sealing blacktop driveways, parking areas, walks and other blacktop surfaces.

SKU NO.	MFG. NO.	SIZE
102625	0096	5 Gal.



DRIVEWAY CLEANER

Ready to use from the can, DRIVEWAY CLEANER is an ideal and effective method of removing dirt, grease, oil and gasoline stains and prepares driveways for the application of driveway sealer.

SKU NO.	MFG. NO.	SIZE
102631	0175	1 Qt.



SPOT-X-BLACK TOP PRIMER

For priming of grease, oil and gasoline spots, stains, and discolorations. Prevents oil and grease spots from "bleeding" through fresh blacktop sealer.

SKU NO.	MFG. NO.	SIZE
102628	0087	1 Gal.
102633	0433	1 Qt.

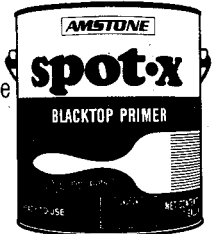

E-Z Stir Filler Sealer

Pro-Seal E-Z Stir Filler Sealer is a driveway reconditioner fortified with latex. Containing skid resistant particles, it fills cracks up to 1/8" wide. The combination of carefully selected ingredients and new processing methods allows the skid resistant particles to remain in suspension while maintaining ease of application. It will mix thoroughly and completely with minimal effort. E-Z Stir coats and protects blacktop and asphalt pavements only.

SKU NO.	MFG. NO.	SIZE
102635	23-1G	Gallon Can
102640	23-5G	5-Gallon
102636	23-1G	Squeeze Bottle Gal



CONCRETE SEALER

Ideal for application to basements; utility rooms, garages, mud rooms. Seals the surface of concrete to retard spreading of concrete dust to other areas. Also protects surface from water and oil stains.

SKU NO.	MFG. NO.	SIZE
102629	0172	GAL



18" METAL/WOOD SQUEEGEE

Professional quality squeegees for the application of driveway sealer material.

SKU NO.	MFG. NO.	SIZE
890345	1800A	18"

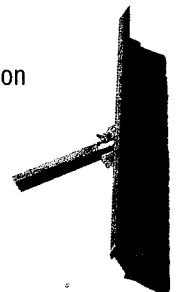



SAKRETE® CONCRETE MIX

A mixture of Portland cement, washed and graded sand and gravel. For repair and building jobs where concrete thickness exceeds 2". Ideal for pouring footings, for anchoring poles and posts; for building walks, drives, curbs and steps. Exceeds ASTM specification C 387.

SKU NO.	MFG. NO.	SIZE
301655	0026	80 lb. bag
301660	0021	40 lb. bag



SAKRETE® HIGH EARLY STRENGTH CONCRETE MIX

A mixture of Portland cement, washed and graded sand and gravel, and special additives. Especially designed for fast setting of posts and poles. Pre-blended, no tools required. Use direct from bag. Ideal for fast, high strength repairs of existing concrete surfaces. Hardens fast for same-day use. Exceeds ASTM specification C 387.

SKU NO.	MFG. NO.	SIZE
301633	0545	60 lb. bag



SAKRETE® MORTAR MIX

A mixture of masonry mortar cement and graded bank sand. Especially designed for laying brick, block and stone. Can be used to repair masonry or used as a stucco. Exceeds ASTM specification C 387.

SKU NO.	MFG. NO.	SIZE
301680	0039	80 lb. bag
301685	0035	40 lb. bag



WHITE MORTAR

A mixture of sand, white Portland Cement, and lime. Ideal for laying glass block. Can also be used for laying brick, concrete block or field stone when a white grout seam is desirable.

SKU NO.	MFG. NO.	SIZE
301693	0601	20 lb. bag



SAKRETE® SAND MIX

An accurate blend of Portland cement and washed sand. Designed for repair and building jobs of less than 2" in thickness. Can be used for patching steps, sidewalls and floors. Can be used as a topping over existing concrete, as a grout for drain tile, as a stucco and as a bedding mix for laying flagstone or slate. Exceeds ASTM specification C 387.

SKU NO.	MFG. NO.	SIZE
301665	0033	80 lb. bag
301670	0029	40 lb. bag



PLUG-TITE® HYDRAULIC CEMENT

Actually stops leaks instantly even when water is still flowing. Sets faster than similar products. Expands to lock in tight. Works under water for swimming pool repairs.

SKU NO.	MFG. NO.	SIZE
301705	0159	50 lb. pail
301710	0478	9 lb. tub



TOP 'N BOND® SELF-BONDING CONCRETE RESURFACER

Resurface broken or chipped concrete with a bright, new finish. Just trowel on TOP 'N BOND® Self-Bonding Cement Mix. Easy-to-use; just add water. Bonds stronger than regular cement mixes

SKU NO.	MFG. NO.	SIZE
301640	0144	40 lb. bag
301645	0143	10 lb. tub

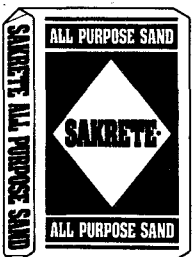

SAKRETE® ALL-PURPOSE SAND

A uniformly graded and sterilized sand. Perfect for use as a soil conditioner, traction material on icy walks, as an absorbent in greasy areas and in pet boxes.

SKU NO.	MFG. NO.	SIZE
301700	0138	60 lb. bag



TUBE BAG GENERAL PURPOSE SAND IN PORTABLE BAG

SKU NO.	MFG. NO.	SIZE
301765		70 LB



SWIFT-SET® SAND MIX

Quick setting! No need to wait days before using patched areas. Non-shrinking; dries to a cement gray color. It even can be used in freezing temperatures. Walk on it in 30 minutes time.

SKU NO.	MFG. NO.	SIZE
301650	0163	40 lb. bag
301651	0164	10 lb. tub



CONCRETE BONDER

For increased strength between new and existing concrete, mortar or plaster. Just brush it on. Increases bond 8 to 10 times. Also for use as a "bond coat" or "admix". Ideal for use with Sakrete Sand Mix or Sakrete Concrete Mix.

SKU NO.	MFG. NO.	SIZE
301720	0150	1 Gal.
301725	0149	1 Qt.



GRAY CRACK FILLER

Fills and seals cracks up to 1/2" wide and 1" deep in concrete. Remains flexible and cures to the color and texture of concrete. Protects from water penetration. Cures completely in 12 to 24 hours of normal temperature and humidity.

SKU NO.	MFG. NO.	SIZE
102644	0683	1 Gal.
102643	0684	1 Qt.

1

**WATER PROOFING
CONCRETE BLOCKS
BRICK & STONE**



THOROSEAL®

Thoroseal is a cement-base, aggregate type, heavy-duty, waterproof coating for concrete and masonry. The aggregates are graded and sized so as to mesh perfectly; are selected for purity, hardness, and structural strength and are non-metallic. When they are combined with other ingredients a free flowing, waterproof coating is produced that possesses high strength, great durability and density.

Uses

Waterproofing concrete, block, brick, stone and other masonry; interior and exterior, above or below grade. Waterproofing stucco and cement plaster. Waterproofing water reservoirs, tunnels, swimming pools, cisterns, basements and cellars. Waterproof back plastering for limestone panels. Also recommended as a base coat for Super Quickseal, Thorosheen and Thorocoat. Waterproof and finish concrete, eliminating the need for rubbing.

SKU NO.	MFG. NO.	COLOR	SIZE
300135	0510	White	10 lb
300130	0460	Gray	60 lb
300150	0560	White	60 lb

AQUA PLUG

Water Stop Hydraulic Cement

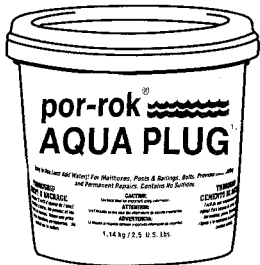

SKU	Mfg. No	Size
301671	49110000	10lb Pail

A durable water resistant hydraulic cement which sets in 3 to 5 minutes. Designed to stop leaks or running water, patch cracks and fill holes in masonry surfaces. Excellent for filling areas where floor and wall meet, or around pipes extending through masonry walls. May be used on interior or exterior surfaces.

**HYDRAULIC CEMENT
WATERPROOF**



WATERPLUG®

A cement-base, quick-set, hydraulic compound which instantly stops running water or seepage through concrete or masonry walls and floors. It actually becomes harder and more resistant when it is subjected to constant water pressure. Packaged in dry powder form, Waterplug requires only the addition of clean water to make ready for use. Waterplug contains no metallics, will not shrink or oxidize, and seals out water for the life of the structure. Waterplug sets in three to five minutes, depending upon the temperature of the mixing water and the surface into which it is applied. Low temperatures will retard the set; high temperatures will accelerate the set.

Uses

Stops running water or seeping through cracks and holes in concrete or masonry walls of basements, elevator pits, wells, mines, tunnels, cofferdams, sewers, cisterns, tanks; seals crack at junction of floor and wall; seals construction faults in concrete and holes left by tie wires, wood or steel separators. Grouts and seals around pipe, anchor bolts, conduits, etc.

SKU NO.	MFG. NO.	SIZE
300210	0203	2½ lb
300215	0210	10 lb
300220	0250	50 lb

**INTERIOR FLOOR
CEMENT**

**THORO®
UNDERLAYMENTS
SELF-LEVELING
AND TROWEL GRADE**



Thoro Underlayment is a cement based product designed specifically to level interior floors prior to applying floor surfacings. It is available in two grades, Self-Leveling and Trowel Grade.

Uses

Use Thoro Underlayment to level surfaces in new construction, remodeling work and corrective work. It is used as a subfloor finish for carpet, tiles, epoxy coatings and other floor-surfacing systems. It can be applied over concrete, wood, steel, ceramic tile and other sound, rigid flooring. It is compatible with common adhesives.

SKU NO.	MFG. NO.	SIZE
300337	2705	40 lb
300340	2700	55 lb
300342	Underlayment Primer #800	Gallon

**BONDING
AGENT**



ACRYL 60®

Acryl 60 is a special formulation of acrylic polymers and modifiers, available in liquid form for use as an additive with portland cement mixes to improve adhesion and mechanical properties. Cement mixes prepared with Acryl 60 are suitable for exterior or interior use; are hard, tough and fast curing; and possess good resistance to most common chemicals. Modified mixes are not affected by exposure to water. Provides positive adhesion over questionable surfaces.

Uses

To add extra bonding qualities when application is to be made over dense concrete or masonry. With Thoroseal and Thoroseal Plaster Mix. With pointing mortars, such as Dryjoint, to improve adhesion and curing. With cement

SKU NO.	MFG. NO.	SIZE
300190	0100	Qt
300195	0101	Gal
300200	0105	5 Gal

**MULTIGROUT
NON-SHRINK MULTI-FLOW
CEMENTITIOUS GROUT**



SKU	Size
301885	50 lb bag

MULTIGROUT is a non-shrink, cementitious grout that utilizes a unique expansion mechanism molecular composition. This composition allows the product to be ideal for a variety of applications/methods including: Packed, Rodded, vibrated, poured or pumped. Thoro MULTIGROUT meets or exceeds Corps of Engineers specifications CRD-C-621 and ASTM C-1107-91a.

ADVANTAGES & TYPICAL USES

Can be used in/to grout machinery bases, structural columns, pump and equipment bases, bearing plates, rail posts, dowel/rebar replacement seating bolts, power line stanchions, industrial plants, (including nuclear facilities, oil refineries, metal fabrication and meat processing, pharmaceutical and grain mills.

Yield: .4 to .5 cu.ft



**TWO
HOURS
TO
DRY**

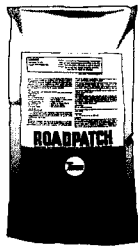

ROADPATCH®

Roadpatch is a cement-base, fibered, fast-setting patching material that develops high compressive strengths and will allow traffic-bearing patches to be put back in service after 2 hours from time of placement. Roadpatch is fortified with special alkali-resistant glass fibers that improve appreciably the impact, flexural and tensile strengths. The use of these special fibers contributes substantially to the ability of the product to resist cracking and abrasion.

Uses

Roadpatch has been used by maintenance departments to patch bridge decks, curbs, expressways and other areas where partial depth patching is required.

SKU NO.	MFG. NO.	SIZE
300275	1850	50 lb

**WATERPROOF
CEMENT**



THORO® STUCCO

Thoro Stucco is a waterproof, mill-mixed, carefully formulated cement-base stucco finish. Every ingredient is carefully prepared, cleaned and properly sized, blended in proper proportion so as to provide a stucco finish that is more durable, more uniform in color and performance.

Uses

As a stucco finish over: a scratch and brown coat of portland cement/lime or portland cement/masonry cement unpainted concrete block; over clean, untreated concrete or cement plastered surfaces; smooth or dense surfaces should receive an application of Thorobond to provide adequate bonding capabilities.

SKU NO.	MFG. NO.	SIZE
300253	1980	80 LB.

**WHITE
BASE
COATING**



SUPER QUICKSEAL®

Super Quickseal is a superior, cement-base coating with a built-in bonding agent for masonry and concrete. Super Quickseal is also recommended as a finish coat over Thoroseal when a smoother finish and an all cement-base coating system is required.

Uses

Superior dampproofing decorative finish for concrete and masonry, above or below grade, inside or out. Ideal for concrete and masonry walls in basements. Use over brick, concrete, block, tile or stone. Ideal for refinishing gunite and cement-plastered walls and stucco.

SKU NO.	MFG NO.	SIZE
300178	4350	50 lb.

**ACRYLIC
POLYMRE**



**CEMENT
BASE**

THOROPATCH®

A two-component, cement-base, acrylic polymer patching compound. Thoropatch is unusually strong, durable and crack-resistant because the bonding agent is acrylic resin, the base ingredient of tough Plexiglas. The dry ingredients are a perfect blend to produce a strong, durable, dense patch. The cement-base mix and acrylic combination produces a concrete surfacing or patch material that is non-shrinking, exceptionally adhesive, crack resistant, with high structural strength.

Uses

To patch, resurface and level concrete floors, walks, steps, ramps, etc., interior or exterior.

SKU NO.	MFG. NO.	SIZE
300285	1150	10 lb
300280	1150	56 lb can

**PATCHING
CONCRETE
MASONRY**



THORITE®

Thorite is a fast-setting, non-shrink patching material with excellent structural strength specifically formulated for patching concrete and masonry. Thorite is packaged ready for use, requiring only the addition of water. It does not contain calcium chloride or waxes, tars, emulsions, metallics of any type. Thorite will not slump from the edges of the patch; its freedom from oxidation and non-shrink qualities make it a very durable patching material.

Uses

Patching honeycomb, spalls, cracks, holes left by tie wires or spreaders and construction faults in concrete; restoring concrete even where reinforcing rods are exposed; patching concrete pipe; repairing stucco; patching precast concrete.

Thoro Underlayment Primer #800 is recommended for concrete, wood, slate, tile, terrazzo & brick. No primer is necessary when applying Thoro Underlayment Trowel Grade to concrete surfaces.

SKU NO.	MFG. NO.	SIZE
300225	01312	12 LB
300235	0360	60 LB

**WATER
PROOF**

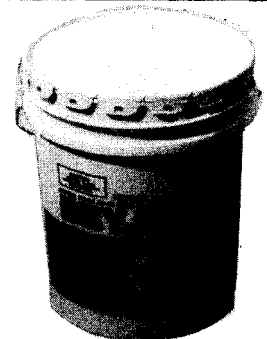

DRYJOINT®

A waterproof cement-base, non-staining pointing mortar packaged in powder form for repointing joints in all types of masonry; brick, stone, tile, terra cotta, limestone. Dryjoint possesses non-shrink qualities, contains no metallics to rust out and discolor the wall. Dryjoint can be applied by tuck-pointing trowel or caulking gun.

Uses

For tuck-pointing of brick, stone, tile, terra cotta or other types of masonry. Contact the manufacturer where a beaded joint is required.

SKU NO.	MFG. NO.	SIZE
300238		50 LB

A-10 ACCELERATORS

WINTER AD MIX
 For Concrete/Masonry

SPECCO® DATA

PRODUCT DATA: A liquid calcium chloride solution that is added to concrete and masonry mixes, to accelerate the normal set-time and to lower the freezing point of the mix. Additionally, A-10 increases the ultimate strength and improves the workability of the batch materials.
 BENEFITS: Provides faster set time...Permits earlier form removal... Provides faster mold turnover.



SKU SIZE
 301581 1 gal



SKU SIZE
 301584 5 gal

G-20 IRON GROUT

For anchoring

PRODUCT DESCRIPTION: A blend of portland cement, selected processed aggregates, clean, coarse and fine iron particles, and specific chemical additives. G-20 is suitable for interior or exterior use and may be used in moist and humid conditions. G-20 produces a tight surface oxidation and will not allow rusting of the inner iron particles. Due to the elongated shape of the iron particles in G-20, the product produces better vibration resistance than grouts containing round shape iron particles. G-20 is used for grouting anchor bolts, setting machinery structural members, embedding signs, posts and machinery in or on fully cured concrete.

BENEFITS: Fast setting...High Strength...Contains no added Chlorides...MIX WITH WATER ONLY.

SKU SIZE
 301578 60lb bag



SB MORTAR

INTERIOR & EXTERIOR
 Water Repellent

A two component concrete repair compound formulated to provide durability, crack resistance, exceptional bonding strength and water repellency. SB Mortar may be applied from feather edge up to 2 in. thick in one application. SB Mortar may be used interior or exterior, above or below grade, on vertical or horizontal concrete and masonry surfaces.

BENEFITS: Exceptional Bonding Strength...Very Durable...Water Repellent



SKU SIZE
 301585 60lb pail

SPECCRETE SPECCOPATCH-RS

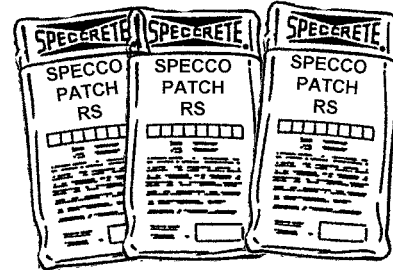

PRODUCT DESCRIPTION: A specially formulated, fast setting, cement based concrete and masonry patching material that requires only the addition of water for mixing. Speccopatch RS may be used interior or exterior, above or below grade on vertical, horizontal and overhead surfaces without forms. After initial set, SPECCOPATCH RS may be shaved to the contours of the surrounding area.

SPECCOPATCH RS is used to repair concrete pipe, manholes, sidewalks, driveways, expressways, ceilings, walls, curbs and panels. SPECCOPATCH RS may be used for applications under constant moisture contact.

BENEFITS: Rapid Setting...Non Shrink...No Added Chlorides...Shapeable... Shaveable...Use in Thin to Thick Layers...Tenacious Bond...Resistant to freeze-Thaw...Light Color.

SKU SIZE
 301540 40lb bag



JIF-SET® is a two component, powder & latex, floor patch/underlayment used for patching and leveling interior subfloors prior to finished floor covering. May be used over any sound concrete or wood subfloor, or for repairing cracks or holes in interior. JIF-SET® is non-shrinking, seeks its own level and is self-bonding to water dampened surfaces. When mixed with LEINWEBER'S LATEX/SILICONE LIQUID, JIF-SET® is self-bonding.

SKU NO.	SIZE	COLOR
302180	10 lb.	SNOW-WHITE
302185	25 lb.	SNOW-WHITE

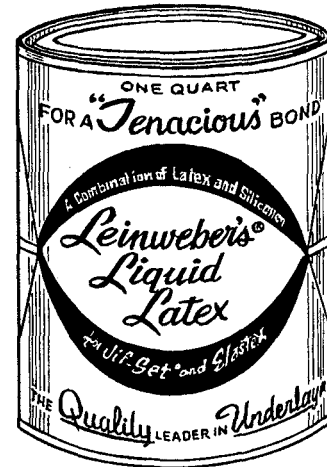

A high strength Latex-Silicone Liquid. Triples the bonding power of Jif-Set or any other manufacturers floor patch.

SKU NO.	SIZE
302190	Quart
302195	Gal.
302197	5 Gal.



VINYL-CRETE® is a two component (powder and latex/vinyl additive) floor underlayment material used for leveling, smoothing and patching both interior and exterior surfaces prior to the installation of finished floor covering.

VINYL-CRETE LIQUID is a special latex fortified with vinyl and silicones. When mixed, the blend is gray in color.

SKU NO.	TYPE	SIZE
302175	POWER	40 lb.
302177	LIQUID	Gal.
302178	LIQUID	5 GAL

PLACE YOUR ORDERS BY FAX ON OUR ORDER FORM TO RECEIVE YOUR SPECIAL 2% DISCOUNT.

WE ARE PLEASED TO SPECIAL ORDER ITEMS THAT ARE NOT ALREADY IN OUR INVENTORY

1

TILE REINFORCING MESH

300863	2 x 2	Sold by the foot 5' x 150' roll
--------	-------	------------------------------------



ASPHALT SATURATED FIBER TYPE

EXPANSION JOINTS

Since concrete contract and expands according to temperature changes, some type of filler is needed between slabs to keep the concrete from buckling when it expands, and to fill the resultant gaps when the concrete contracts. Expansion joints or isolation joints are used between slabs ant to separate slabs from structures, thus preventing damage during expansion and contraction cycles.

All strips are 5 feet in length and 1/2" thick.

WIDTH	4"	5"	6"
SKU	300890	300895	300900

FORM OIL

A release agent for concrete forms that is a straight petroleum oil (no additives) Low viscosity, non staining. Can be used on wood or metal forms.

SKU NO.	SIZE
301750	5-GAL

FORM TIES — D STYLE

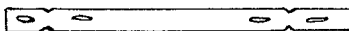

SKU	SIZE
301850	8"
301855	10"
301860	12"



REINFORCING MESH

Welded wire (10 gage) mesh 6" x 6" fabric provides uniform stress and distribution and more effective crack control in slab construction. Roges are 5' wide by 150' long

Wire mesh rolls have been used successfully in concrete crack control of concrete for 50 years. This product offers a convenient reinforcing material that can be cut to size for various project applications. The location of wire mesh in the slab is a very important consideration. The purpose of placing mesh in slab is a very important consideration. The purpose of placing mesh in slab on grade is to control cracking caused by shrinkage, temperature changes, and unequal subgrade support. Therefore, the proper location of the wire mesh is to place it close to the top surface, where cracking is most possible. A good rule of thumb for single layer slabs is to locate the mesh not less than 1", nor more than the top 1/3 of the slab depth from the surface.

STANDARE WIRE MESH ROLLS — PLAIN			
ROLL SIZE	SPACING	STEEL & WIRE GAUGE	APPROX. WT./PER ROLL
5' x 150'	6 x 6	10/10	155 lbs.

SKU	SIZE	
300860	5' x 150'	
300860F	5' x 1'	*Add cutting charge



ANCHOR BOLTS

SKU NO.	SIZE
300800	3/8" x 6"
300805	3/8" x 8"
300810	3/8" x 10"
300815	3/8" x 12"
300825	1/2" x 6"
300830	1/2" x 8"
300831	1/2" x 18"
300835	1/2" x 10"
300840	1/2" x 12"
300844	1/2" x 14"
300845	1/2" x 16"
300846	5/8" x 12"

CONCRETE FORMING TUBES

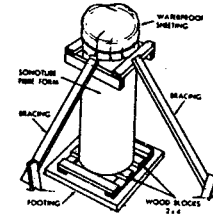

Fibre Forms are lightweight, easy-to-handle fibre tubes that can save you time and money in pouring beautiful round concrete columns.

The one-piece forms eliminate fabricating and assembly. They can be cut to length on the job site and erected, braced and stripped quickly. Since they are disposable, all forms can be poured at once.

SKU	SIZE
300994	6" x 4'
300997	6" x 12'
301000	8" x 4'
301004	8" x 12'
301005	10" x 4'
301006	10" x 12'
301010	12" x 4'
301014	12" x 12'
301017	24" x 4'

REBAR

Reinforcing Bar
Length - 20' Stock



DIA	3/8" #3	1/2" #4	5/8" #5	3/4" #6
SKU	300850	300855	300857	300858

Can be cut to any length at an additional charge

The design of reinforced concrete structures requires engineering analysis to determine the proper thickness of the concrete section and the amount and placement of the steel reinforcement required to handle tensile and shear stresses within the section. Steel reinforcement is also required to provide positive ties between vertical and horizontal structural elements, reinforce edges around openings, and control shrinkage movement.

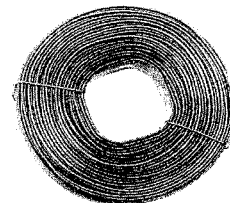

REBAR TIE WIRE

Georgia-Pacific rebar tie wire is manufactured to meet the specifications of most belt dispensers on the market today. It is a very soft annealed wire, assuring the utmost flexibility for fast tying, yet providing necessary strength for secure ties. **SKU NO. 300910**

CS-309™

ACRYLIC CURING AND SEALING COMPOUND



Cures and seals freshly placed concrete in one economical operation.

SEALTIGHT CS-309 Acrylic Curing and Sealing Compound is a clear, transparent, ready-to-apply non-yellowing liquid compound designed to cure and seal freshly placed concrete in one efficient operation.

Specifications
 ASTM C 309, Type 1, Class B
 AASHTO M 148, Type 1 Class B
 USDA Accepted

SKU NO.	MFG NO.	SIZE
301097	300SF	Gal.
301098	300SF	5 Gal.

Acrylic Sealer (Clear)



THOROGLAZE®

Thoroglaze is a clear, non-yellowing acrylic sealer for concrete and masonry. Sealer is a methyl methacrylate base. Thoroglaze finish has a clear, uniform "wet" look. The Thoroglaze film breathes.

Uses

For concrete and masonry, exposed aggregate panels, stucco and cement-based textured finishes.

SKU NO.	MFG. NO.	SIZE
300320	1201	GAL
300325	1205	5 GAL

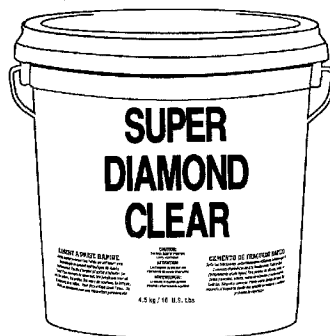

SUPER DIAMOND CLEAR

To provide a quality cure and seal while assuring a total resistance to yellowing from ultraviolet exposure and suitable for use on interior and exterior concrete. Has excellent bonding and forms a continuous glossy membrane to make the surface resistant to dirt penetration and other staining. Protect fresh concrete from rain damage after drying.

SKU NO.	MFG. NO.	SIZE
301840	EUCCO	1 GALLON
301820	EUCCO	5 GALLON



TIAH® Concrete Sealer

SEALTIGHT TIAH is an acrylic copolymer solution that dries to a clear, colorless, abrasion-resistant film. TIAH will not after-yellow or change the natural color of concrete. Specially formulated to enhance the beauty of most cementitious materials. TIAH provides a highly weatherproof, stain-resistant and dustproof sealer. It can be used on driveways, patios, swimming pool areas, exposed aggregate as well as any interior or exterior surface where protection and sealing of concrete is desired. TIAH is used where a high or medium sheen is desired on the concrete.

SKU NO.	MFG NO.	SIZE
301091	300SF	Gal.
301096	300SF	5 Gal.



SPECCO® PEBBLESHEEN® CLEAR/TINTED

SPECCO® PEBBLESHEEN® is a clear or tinted high solids, film-forming, curing, sealing, and dustproofing compound. It will provide good resistance against discoloration and wear. Use PEBBLESHEEN to enhance the beauty of natural stone aggregate surfaces, horizontal or vertical while providing maximum protection to the surface. The finished coating will have a shinely wet look.

SKU NO.	MFG. NO.	SIZE
301557	C15 Clear	Gal
301558	C15 Clear	5 Gal
301557	C15 Merrimac	Gal
301556	C15 Merrimac	5 Gal

1

DUR-O-WAL®

SINGLE WYTHE WALLS

Stack Bond Load
 Bearing Walls.
 8" c. to c.
 Top 3

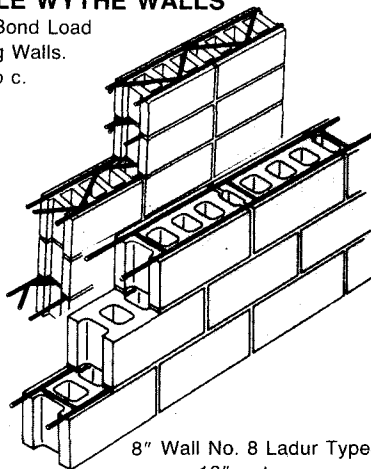

8" Wall No. 8 Ladur Type
 16" c. to c.

PRODUCT DESCRIPTION

Dur-O-wal truss is a prefabricated reinforcement especially designed for embedment in the horizontal mortar joints of masonry. It is manufactured in 10 ft. lengths. Dur-O-wal truss consists of two or more parallel, longitudinal rods weld-connected to a continuous, diagonally oriented cross rod, thus forming a truss design. The continuous, diagonally oriented cross rod is electrically butt-welded to deformed side rods, in a single plane. Out-to-out spacing of side rods is approximately two inches less than the nominal thickness of the wall or wythe in which the reinforcement is placed.

SKU NO.	MFG NO.	SIZE
300864	4-S Galv.	4"
300869	6-S Galv.	6"
300874	8-S Galv.	8"



NO. 600 DETERGENT

A concentrated blend of surface acting acids, chelating and wetting agents formulated as a high efficiency, general purpose cleaner for new masonry surfaces. No. 600 Detergent removes mortar/grout stains, efflorescence and other new construction stains from masonry and concrete surfaces which are not subject to metallic oxidation. Will not discolor or damage the surface—safer and more efficient than muriatic acid.

SKU NO.	MFG NO.	SIZE
301200	0100095	½ Gal
301205	010195	Gal
301206	00105	5 Gal

CORRUGATED WALL TIES

Galvanized steel, 7/8" wide x 7" long. Available in 28 gage, 22 gage, and 16 gage.

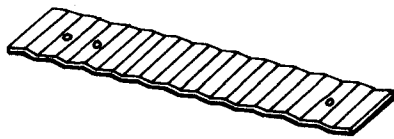

SKU NO.	PIECES PER PACK
300905	1
300906	1000

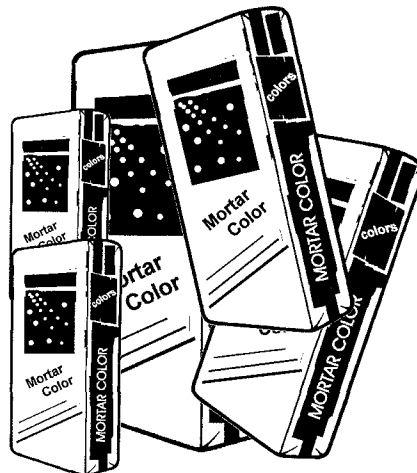

MORTAR COLORS DESCRIPTION

Basic Use: Mortar Colors are pure mineral pigments designed to be used with all cementitious material whether it may be a Type N, S, M or O strength masonry cement or portland and lime mixtures. The premeasured unit concept of colors provides uniform color control with the flexibility of utilizing local masonry and/or portland and lime cements to achieve the proper strength and mix design for brick, block, stucco or stone unit construction.

SKU NO.	MFG NO.	SIZE
300370	014	Light Buff
300380	018	Dark Buff
300375	060	Med. Buff
300452	070	Dark Buff 50#
300449	150	Light Buff 50#
300395	203	Patton Brown
300400	305	Brown
300443	350	Brown 50#
300385	518	Chocolate
300446	660	Chocolate 50#
300365	711	Red
300440	740	Red 50#
300456	965	Black 50#

MORTAR BOX

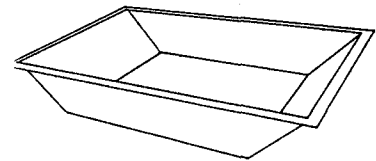

SKU NO.	MFG. NO.	DEPTH	WIDTH	LENGTH	WEIGHT	CAPACITY
300975	0	11"	24.5"	47.0"	33 lbs.	5.5 cu.ft
300980	1	11"	32.5"	60.0"	57 lbs.	9 cu.ft
300985	2	11"	40.5"	87.5"	117 lbs.	17.5 cu.ft

Foundation Vents

Cast aluminum vents used to provide ventilation to crawl spaces and basements

SKU NO	MANUFACTURER NUMBER	SIZE
301845	10 W	8" X 16"

Silt Fence

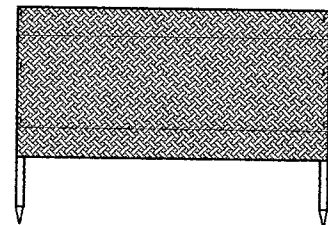

DGI Silt Fence is constructed utilizing the finest sediment control fabrics available. Water is allowed to pass through the fabric, while costly suspended soil particles are trapped to settle to the ground. This restricts the loss of costly job site material, keeps our roads and highways free of mud and protects our rivers and lakes from harmful silt build-up.

SKU NO.	SIZE
106100	36"X100' W/Stakes

SPLASH MATTS
SIZE 12" x 24"
NATURAL

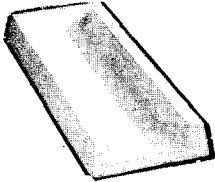

SKU NO. 221015

PATIO BLOCKS
MACHINE PRESSED

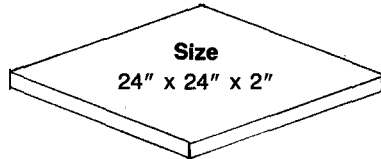

Size
 24" x 24" x 2"

SKU
 NO.
 221010

CHIMNEY CAPS

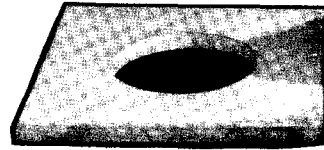

SKU No.	Size	Type
220985	16" x 16"	Square Flue
220995	18" x 18"	Square Flue
220990	18" x 18"	Round Flue
221000	24" x 24"	Square Flue
221005	24" x 24"	Round Flue
221011	28" x 28"	Square Flue
221008	28" x 28"	Round Flue

CONCRETE BLOCKS

0403

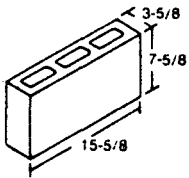

4 x 8 x 16
 STRETCHER
 SKU NO. 301035

0603

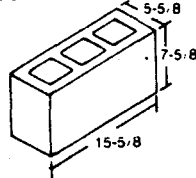

6 x 8 x 16
 STRETCHER
 SKU NO. 301040

0802

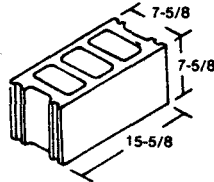

8 x 8 x 16
 STRETCHER
 SKU NO. 301045

1002

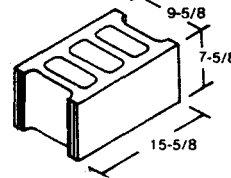

10 x 8 x 16
 STRETCHER
 SKU NO. 301050

1202

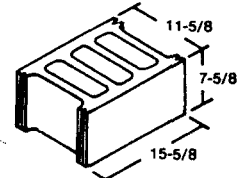

12 x 8 x 16
 STRETCHER
 SKU NO. 301055

BRICKS

0203

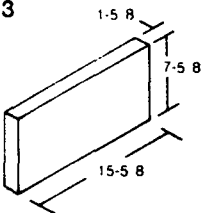

2 x 8 x 16
 SOLID
 SKU NO. 301059

0207

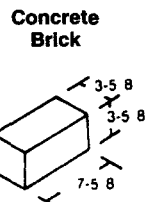

Concrete Brick
 4 x 4 x 8
 SOLID
 SKU NO. 301060

Fire Brick

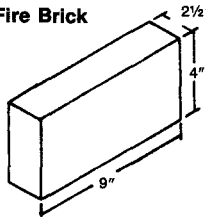

4 1/2" x 9" x 2 1/2"
 SOLID
 SKU NO. 301070

Solid End Blocks

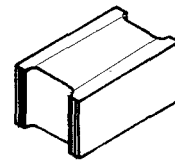

SKU Size
 301100 8"x8"x16"
 301103 6"x8"x16"

A/B Face Brick

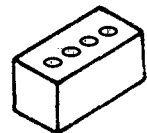

SKU Size
 301085

CHIMNEY BLOCK

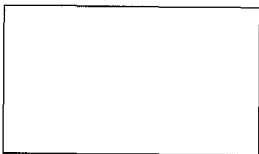

SKU Size
 201306 14"
 201309 16"

PARKING STOP

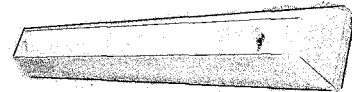

7' Standard - 12" Pin - Approx 235lbs - 6" H x 9" W

SKU
 201303

GLASS BLOCKS

Energy Conservation

When the two halves of a glass block are fused together, a partial vacuum is created within the block. This vacuum gives glass block the insulating value of a 12-inch thick concrete wall.

Security Advantages

Glass blocks are exceptionally rugged. The transparency and light transmission characteristics provide security without creating a "closed-in" feeling.

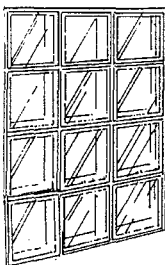

SKU	SIZE	TYPE
301300	6" x 6" x 4"	NUBIO*
301305	8" x 8" x 4"	NUBIO*
301310	8" x 8" x 3 1/8"	NUBIO*
301290	8" x 8" x 4"	CLEAR
301295	12" x 12" x 4"	CLEAR

*NUBIO offers excellent distortion and privacy random intersecting waves provide an attractive marble-like appearance

FIRE BARRIER SYSTEMS

metacaulk 1000 INTUMESCENT FIRESTOP SEALANT

Metacaulk® 1000 is a water based, flexible, highly intumescent sealant designed for use on metal, insulated, fiberglass and plastic pipes. It can also be used for top of the wall construction joints, power and telephone cables.

- ◆ UL Classified up to 3 hours
- ◆ Meets ASTM E 814, UL 1479 and UL 2079 Standards
- ◆ Remains flexible
- ◆ Non-sagging, non-toxic, no VOC's
- ◆ Economical
- ◆ Will not re-emulsify after cure
- ◆ Paintable
- ◆ Available in cartridges and pails

SKU	Size
458500	10.3 oz tube
458506	30 oz tube
458505	5 gal. pail



Metacaulk® 1000 has passed UL 2079 for top of the wall applications with fiberglass backing and as little as 1/4 inch depth of caulk. The test assembly was also subjected to 500 cycles on a specially built machine that successfully demonstrated the product's durability and movement characteristics.



FIRE RATED MORTAR

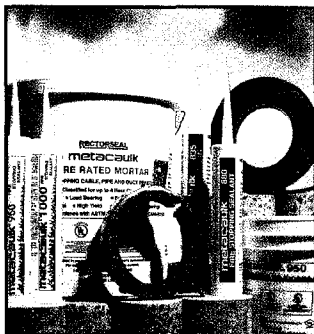

SKU	Size
307500	20 lb pail



**3M CP-25WB+
FIRE BARRIER CAULK**

Premium, intumescent latex/water-based caulk. Provides easy clean-up and routine disposal with no special handling. One-part system with no mixing or measuring require Intumescent and endothermic. Dries fast and tack-free in approximately 10-15 minutes.

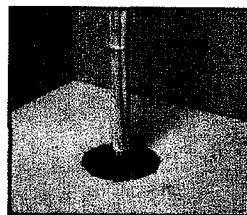
SKU NO.	MFG NO.	SIZE
457108	07580-3	10.5oz

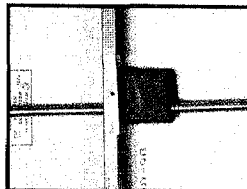

Metacaulk® Putty Sticks are used to seal around penetrating items through fire rated walls, floors and within blank openings. For use with electrical cables, conduit and metal pipes. Hand moldable with no curing time required. Will not dry out and can be re-used as additional penetrating items are removed or installed.



Metacaulk® Putty Pads are used to maintain the hourly rating of fire rated walls containing electrical outlet boxes and to reduce sound transmission. Only one pad thickness (1/8 inch) is required for a 1 or 2 hour fire rating. No additional putty material needed to plug the end of each electrical metallic tube or conduit at its connection to the box.



SKU	Size
458509	18 cu.in. Putty Stick
458512	6"x7"x1/8" Putty Pac

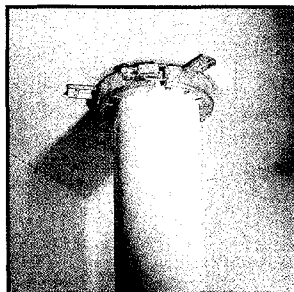

Metacaulk® Pipe Collars are prefabricated for through-penetration firestop systems using PVC, CPVC, ABS, PVC foam core and ABS foam core pipe. UL Classified for both open and closed pipe systems.

- ◆ 25% reduction of installation time
- ◆ Simple lock-in mechanism for easy installation
- ◆ Economical - no backfill required
- ◆ No measurement of material required
- ◆ Fits in limited access areas



SKU	Size
607100	1-1/2"
607103	2"
607106	3"
607109	4"

ASH DUMPS – SOLID CAST IRON

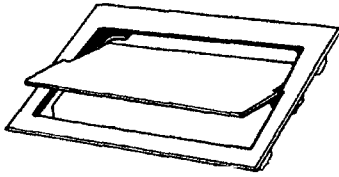

SKU NO.	Model No.	Size
300520	49	4½" x 9"

ASH DUMPS – ALL STEEL



SKU NO.	Model No.	Size
300525	ST-49	4½" x 9"

OUTDOOR FIREPLACE GRATES – CAST IRON
 FOR DO-IT-YOURSELF BARBECUE UNITS

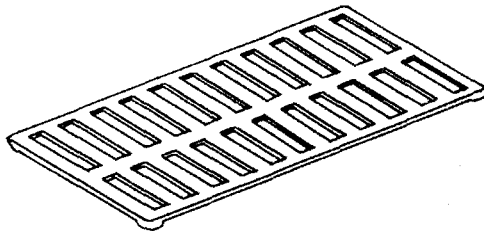

SKU NO.	Model No.	Description	Size
202110	16-G*	Grated	11½" x 16½"
202112	24-G	Grated	11 7/8" x 23 5/8"

**FIREPLACE DAMPER – CAST IRON BODY
 STEEL VALVE PLATE – POKER CONTROL**

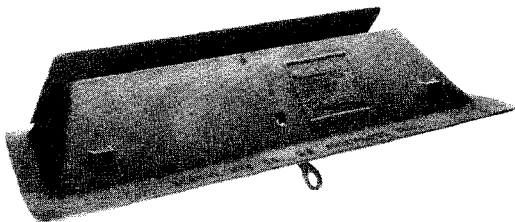

SKU NO.	Throat Dimensions			Height	Overall Dimensions		
	Front	Back	Depth		Front	Back	Depth
300460	24"	18"	10"	6"	28"	21"	13½"
300465	30"	23"	10"	6"	34"	26¾"	13½"
300470	33"	26"	10"	6"	37"	29¾"	13½"
300475	36"	29"	10"	6"	40"	32¾"	13½"
300480	42"	35"	10"	6"	46"	38¾"	13½"
300485	48"	41"	10"	6"	52"	44¾"	13½"

VENTED CAST IRON CLEANOUT DOOR

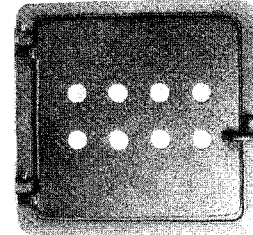

SKU NO.	Model Number	Description
300510	88C10A	Cast Iron Cleanout Vented for Outside Air 8x8

**SOLID CLEANOUT DOOR
 GALVANIZED STEEL TO PREVENT CORROSION**

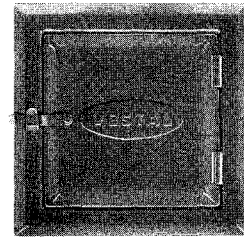

SKU NO.	Model No.	Width By Height
300515	ST88	8" x 8"

RECTANGULAR FLUE LINING

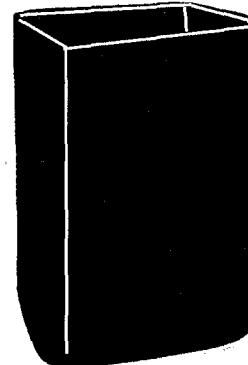

SKU NO.	SIZE
300455	8" x 8" x 2'
300450	8" x 12" x 2'
300445	12" x 12" x 2'
300758	13" x 18" x 2'

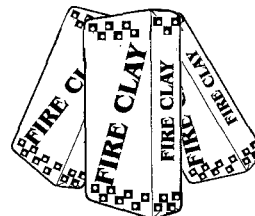

SKU	Size	Description
300035	50lb bag	
301570	9lb can	Powdered Fireplace Cement



PAVING STONES

TYPICAL CROSS SECTION OF HOLLANDSTONE INSTALLATION

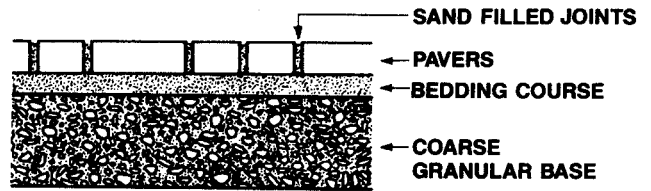

LAYING PATTERNS

HOLLANDSTONE

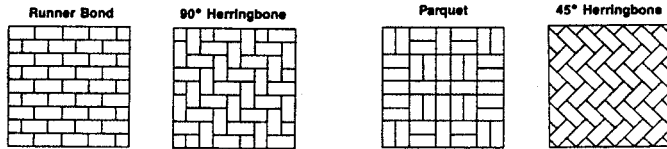

6 cm/2.36"

STONE SKU	Stock Colors
301068	Terra Cotta
301069	St. Clair
301071	Windy City
301066	Autumn Red
301067	Rustic Red
301056	Brown
301054	Charcoal
301052	Nevada
301051	Red

Layers/Bundle	9
Stones/Bundle	486
Square Ft./Bundle	106.1
Weight/Bundle	2977 lbs.
Sections/Bundle	6
Stones/Section	81
Square Ft./Section	17.7

HOLLANDSTONE

SIZE: 7.9" x 3.9"
 STONES/SQ. FT.: 4.57
 SQUARE FT./STONE: .218
 NOTE: Also available in 90° 8 cm Herringbone pattern for mechanical installation.

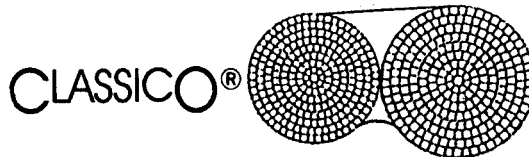
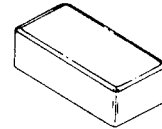

BUNDLE SKU	STOCK COLOR	Circle Bundle	7 cm/2.76"
301082	Rustic Red	Small Circle Stones/Bundle	32*
		Large Circle Stones/Bundle	256
		Square Stones/Bundle	280
		No. of Circles/Bundle	3
		Square Ft./Bundle	72.6
		Weight/Bundle	2359 lbs.
301083	Rustic Red	Square and Small Rectangle Bundle	
		Square Stones/Bundle	512
		Small Rectangle Stones/Bundle	96
		Square Ft./Bundle	88.7
301087	St. Clair	Layers/Bundle	9
		Weight/Bundle	2898 lbs.
STONE SKU	COLOR	Large Rectangle Bundle	
		Large Rectangle Stones/Bundle	448
		Square Ft./Bundle	93.3
		Layers/Bundle	8
301163	St. Clair	Weight/Bundle	3032 lbs.

CLASSICO®

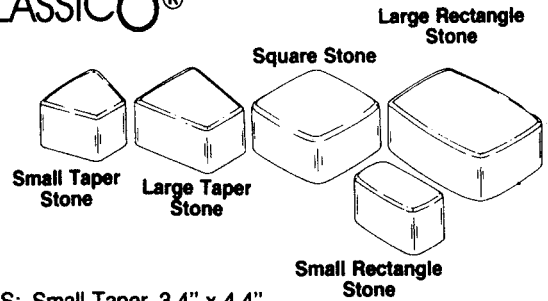

SIZES: Small Taper 3.4" x 4.4"
 Large Taper 4.5" x 4.4"
 Square Stone 4.5" x 4.5"
 Large Rect. 6.8" x 4.5"
 Small Rect. 4.5" x 2.2"

*Eight small circle stones are required for each circle.
 CANNOT BE SECTIONED.

UNILOCK Video tape available for loan to the do-it-yourselfers.....

SYMETRY

PAVING STONES

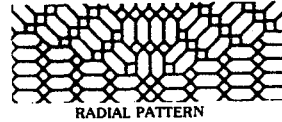

STONE SKU	STOCK COLOR		6 cm/2.36"	SYMETRY	
301143	ST CLAIR	Layers/Bundle Stones/Bundle Square Ft./Bundle	9 288 96.0	SIZE: 10.75" x 4.38" SQUARE FT./Stone: .335 U.S. Patent No. 4,544,305	
301144	TERRA COTTA	Weight/Bundle Sections/Bundle Stones/Section Square Ft./Section	2688 lbs. 4 72 24.0		
301146	BROWN	Layers/Bundle Stones/Bundle Square Ft./Bundle	9 378 104.4	SYMETRY SQUARE SIZE: 6.25" x 6.25" STONES/SQ. FT.: .362 SQUARE FT./STONE: .276 U.S. Patent No. 4,544,305	
301147	CHARCOAL	Weight/Bundle Sections/Bundle Stones/Section Square Ft./Section	2922 lbs. 7 54 14.9		

UNI-DECOR®

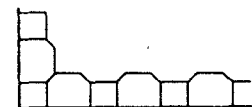
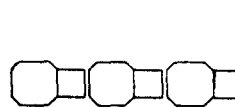
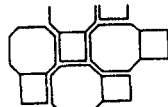
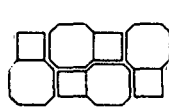

STONE SKU	STOCK COLOR			UNI-DECOR®	
301076	ST CLAIR	Layers/Bundle Stones/Bundle Square Ft./Bundle	9 360 102.9	SIZE: 8.9" x 5.4" STONES/SQ. FT.: 3.5 SQUARE FT./STONE: .286	
301074	TERRA COTTA	Weight/Bundle Sections/Bundle Stones/Section Square Ft./Section	2880 lbs. 5 72 20.5		
301072	RUSTIC RED			Unilock® is the authorized producer of this product covered under U.S. Patent No. 4,128,357.	
301077	ST CLAIR	Layers/Bundle Stones/Bundle Square Ft./Bundle	10 400 101.5	UNI-DECOR® EDGING SIZE: 8.9" x 4.5" STONES/SQ. FT.: 3.94 SQUARE FT./STONE: .254	
301078	REDWOOD	Linear Ft./Bundle Weight/Bundle Sections/Bundle	301 2842 lbs. 5		
301080	AUTUMN RED	Linear Ft./Section Square Ft./Section Stones/Section	60.2 20.3 80	Unilock® is the authorized producer of this product covered under U.S. Patent No. 4,128,357.	
301075	TERRA COTTA				
301073	RUSTIC RED				
301079	REDWOOD				
301081	AUTUMN RED				

ACCESSORIES

JOINTING SAND



PAVE TECH
10' Length, Rigid & Flex

301210 RIGID
301211 FLEXIBLE



SNAP EDGE
8' Length, One-Piece System

301207



10' ARDOX SPIKES

850547 PER LB



FILTER FABRIC

751485 3' x 150'
751486 6' 3" x 300'

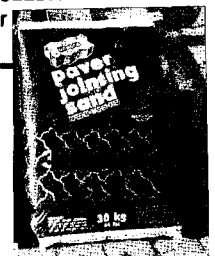

302371



PAVER BOND
300182



RETAINING WALLS

PISA II®

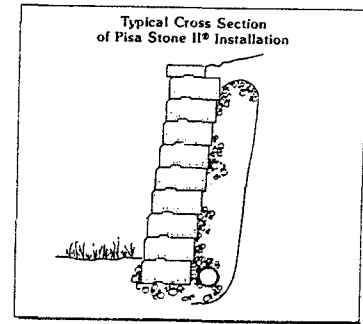
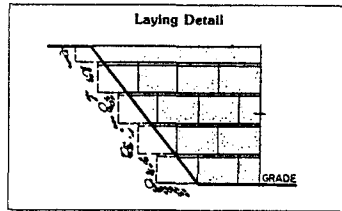

DOUBLE STONE SKU	STOCK COLOR	PISA II®	Pisa II® Wall																								
		<p>NOTE: Minimum Inside Radius = 8 feet</p>	<table border="1"> <tr> <td>Size</td> <td>Tapered</td> </tr> <tr> <td>Face Ft./Bundle</td> <td>19.8</td> </tr> <tr> <td>Double Units/Bundle</td> <td>30 Double Units</td> </tr> <tr> <td>Units/Ft.</td> <td>3</td> </tr> <tr> <td>Weight/Double Unit</td> <td>90 lbs.</td> </tr> <tr> <td>Weight/Bundle</td> <td>2700 lbs.</td> </tr> <tr> <td>Sections/Bundle</td> <td>2</td> </tr> <tr> <td>Double Units/Section</td> <td>15</td> </tr> <tr> <td>Weight/Section</td> <td>1350 lbs.</td> </tr> </table>	Size	Tapered	Face Ft./Bundle	19.8	Double Units/Bundle	30 Double Units	Units/Ft.	3	Weight/Double Unit	90 lbs.	Weight/Bundle	2700 lbs.	Sections/Bundle	2	Double Units/Section	15	Weight/Section	1350 lbs.						
Size	Tapered																										
Face Ft./Bundle	19.8																										
Double Units/Bundle	30 Double Units																										
Units/Ft.	3																										
Weight/Double Unit	90 lbs.																										
Weight/Bundle	2700 lbs.																										
Sections/Bundle	2																										
Double Units/Section	15																										
Weight/Section	1350 lbs.																										
302225	ST CLAIR	<p>After Split</p>																									
302335	ST CLAIR	<p>Corner After Split</p>	<table border="1"> <tr> <td>Corner Unit</td> <td>Size</td> <td>6" x 8" x 20"</td> </tr> <tr> <td>Double Units/Bundle</td> <td></td> <td>9 Double Units</td> </tr> <tr> <td>Weight/Double Unit</td> <td></td> <td>160 lbs.</td> </tr> <tr> <td>Weight/Bundle</td> <td></td> <td>1440 lbs.</td> </tr> <tr> <td>Sections/Bundle</td> <td></td> <td>3</td> </tr> <tr> <td>Double Units/Section</td> <td></td> <td>3 Double Units</td> </tr> <tr> <td>Weight/Section</td> <td></td> <td>480 lbs.</td> </tr> </table>	Corner Unit	Size	6" x 8" x 20"	Double Units/Bundle		9 Double Units	Weight/Double Unit		160 lbs.	Weight/Bundle		1440 lbs.	Sections/Bundle		3	Double Units/Section		3 Double Units	Weight/Section		480 lbs.			
Corner Unit	Size	6" x 8" x 20"																									
Double Units/Bundle		9 Double Units																									
Weight/Double Unit		160 lbs.																									
Weight/Bundle		1440 lbs.																									
Sections/Bundle		3																									
Double Units/Section		3 Double Units																									
Weight/Section		480 lbs.																									
302220	NATURAL	<p>Reverse-A-Cap</p>	<table border="1"> <tr> <td>Revers-A-Cap®</td> <td>Size</td> <td>Tapered</td> </tr> <tr> <td>Units/Bundle</td> <td></td> <td>72</td> </tr> <tr> <td>Weight/Unit</td> <td></td> <td>26.43 lbs.</td> </tr> <tr> <td>Weight/Bundle</td> <td></td> <td>1492 lbs.</td> </tr> <tr> <td>Sections/Bundle</td> <td></td> <td>3</td> </tr> <tr> <td>Units/Section</td> <td></td> <td>24</td> </tr> <tr> <td>Weight/Section</td> <td></td> <td>635 lbs.</td> </tr> <tr> <td>Layers/Bundle</td> <td></td> <td>6</td> </tr> </table> <p>NOTE: 6 end Caps per bundle</p>	Revers-A-Cap®	Size	Tapered	Units/Bundle		72	Weight/Unit		26.43 lbs.	Weight/Bundle		1492 lbs.	Sections/Bundle		3	Units/Section		24	Weight/Section		635 lbs.	Layers/Bundle		6
Revers-A-Cap®	Size	Tapered																									
Units/Bundle		72																									
Weight/Unit		26.43 lbs.																									
Weight/Bundle		1492 lbs.																									
Sections/Bundle		3																									
Units/Section		24																									
Weight/Section		635 lbs.																									
Layers/Bundle		6																									
302330	ST CLAIR	<p>Unilock® is the authorized producer of this product covered under U.S. Patent No. 4,490,075. Pisa II® and Revers-A-Cap® exclusively licensed by Risi Stone, Ltd.</p>																									

NOTE: Video tape cassettes are available at no charge which are instructional and give the user a first hand view of how to install the paving stone and retaining wall systems

**PLACE YOUR ORDERS BY FAX ON
 OUR ORDER FORM TO RECEIVE
 YOUR SPECIAL 2% DISCOUNT.**

**WE ARE PLEASED TO SPECIAL
 ORDER ITEMS THAT ARE NOT
 ALREADY IN OUR INVENTORY**



RETAINING WALLS

1

GARDEN STONE®

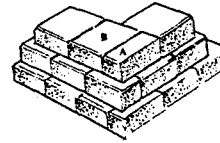

DOUBLE STONE SKU	STOCK COLORS	GARDEN STONE®		Size	
302010	Natural	Tapered Unit Tapers to 7" NOTE: 1 Double Unit = .5 sq.ft. Garden Stone does not require a coping unit.		4.5" X 8"	
302020	Sand			Face Ft./Bundle	27
302000	Natural			Double Units/Bundle	54 Double Units
302015	Sand			Weight/Double Unit	42.5 lbs.
				Weight/Bundle	2295 lbs.
				Sections/Bundle	3
				Double Units/Section	18 Double Units
				Weight/Section	765 lbs.

PISA STONE®

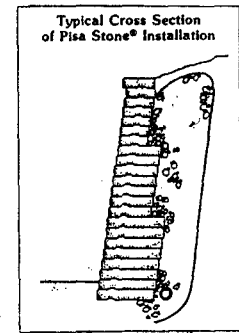
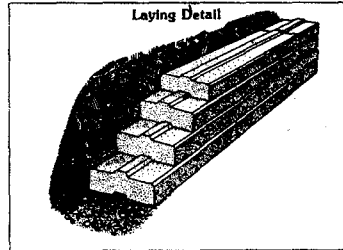

DOUBLE STONE SKU	STOCK COLOR	PISA STONE®		Packaging for 8", 12", 16", Corner, & 12" Coping	
302100	Natural	NOTE: 8" x 8" x 8" Unit has 24 sq.ft./bundle. All other units - 16 sq.ft./bundle Unilock® is the authorized producer of this product covered under U.S. Patent No. 4,490,075.		Slabs/Bundle	16
302194	St. Clair			Slabs/Section	8
302120	Natural	Corner Unit		Weight/Section	1160 lbs.
302110	Natural	Coping Unit		Weight/Slab	145 lbs.
302198	St. Clair				Weight/Bundle
				Sections/Bundle	2
				Slabs/Section	8

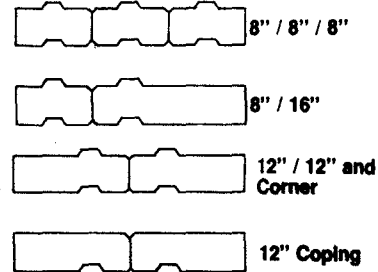

CLEANER for PAVING STONES & RETAINING WALLS

SKU	SIZE	DESCRIPTION
300161	Gallon	UNICARE #1: Natural oil and grease remover.
300165	Gallon	UNICARE #2: Efflorescence remover and general purpose cleaner to prepare surfaces for sealer applications.



SKU	SIZE	DESCRIPTION
300166	1/2 Gallon	UNICARE #3: Rust Remover.
300168	Qt	UNICARE #4: Paint & Tar remover.

1

WINDOW WELLS

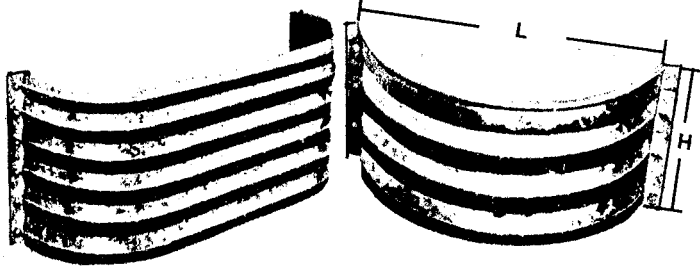

STRAIGHT STYLE

ROUND STYLE

18 GAUGE CULVERT CORRUGATION

SKU NO.	CODE	"L"	"W"	"H"	STYLE
300585	ER	37	20	12	ROUND
300595	ER	37	20	24	ROUND
300620	ER	40	20	12	ROUND
300630	ER	40	20	24	ROUND
300655	ERS	46	20	12	ROUND
300690	EAC	42	24	12	STRAIGHT

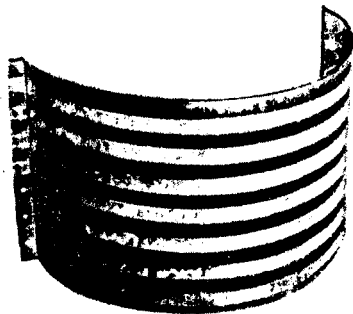

STANDARD-HEAVY CORRUGATES (20 GAUGE) ROLLED TOP

SKU NO.	CODE	"A"	"B"	"C"	STYLE
300725	TR	37	16	12	ROUND
300735	TR	37	16	24	ROUND

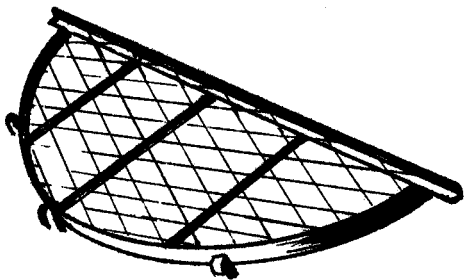

EDGEKO EXPANDED METAL WINDOW WELL GUARDS

SKU NO.	SIZE	STYLE
300570	R32 x 16	32 x 16 ROUND GUARD
300560	S37 x 12	37 x 12 SQUARE GUARD
300550	S37 x 16	37 x 16 ROUND GUARD
300545	R37 x 20	37 x 20 ROUND GUARD
300565	R40 x 20	40 x 20 ROUND GUARD
300580	S42 x 24	42 x 24 SQUARE GUARD
300575	R46 x 20	46 x 20 ROUND GUARD

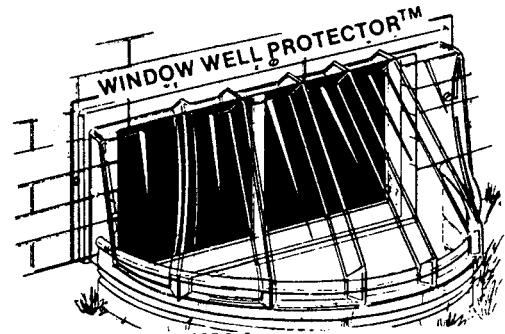

CIRCULAR WELL INSTALLATION

SKU NO.	ITEM #	L x W x H
750915	W42171	42 x 17 x 15

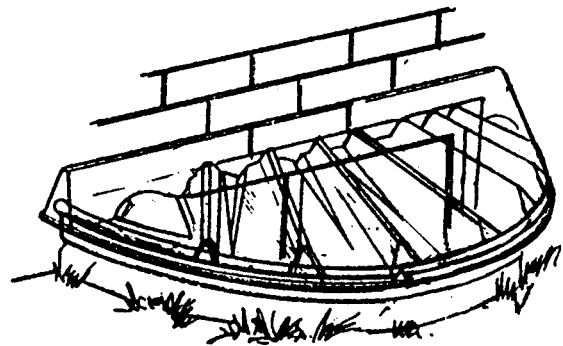

SKU NO.	ITEM NO.	SHAPE	UNIT SIZE (L x W x H)
750894	4017C		40" x 17" x 4"
750912	3517C		35" x 17" x 4"
750909	4020C		40" x 20" x 4"
750900	4822C	C-CIRCULAR	48" x 22" x 4"
750903	4425R		44" x 25" x 4"
750897	4013E		40" x 13" x 4"
750906	4425E		44" x 25" x 4"

WINDOW WELL COVER

SKU	Mfg. No.	Size
750922	4236EG	44"x38"x4"
750925	5836EG	60"x38"x4"