



PISTOL GRIP NOZZLES

Comfort Grip Nozzle



- Molded on, black vinyl grip is cushioned for comfort
- Male hose threaded front for attaching accessories
- Solid brass valve stem with permanent adjusting nut
- Hold-open clip for continuous spraying

MFG. NO. 593TFGT SKU NO. 296855

Insulated Pistol Grip Nozzle with Threaded Front



- Insulated molded grip for spraying hot or cold water
- Male hose threaded front for attaching accessories
- Rubber head guard to protect threads
- Solid brass valve stem with permanent adjusting nut

MFG. NO. 591TFRGT SKU NO. 492832

Full Size Zinc Pistol Grip Nozzle

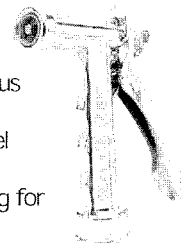

- Solid brass valve stem with permanent adjusting nut
- Hold-open clip for continuous spraying
- Rust resistant stainless steel spring
- Self-adjusting "duck" packing for lifetime leakproof seal

MFG. NO. 593GT SKU NO. 147934

Full Size Zinc Pistol Grip Nozzle with Threaded Front

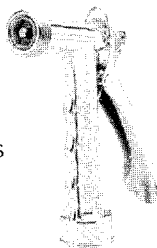

- Male threaded front for attaching accessories
- Solid brass valve stem with permanent adjusting nut
- Hold-open clip for continuous spraying
- Rust resistant stainless steel spring

MFG. NO. 573FGT SKU NO. 249227

Mid-Size Zinc Pistol Grip Nozzle with Polymer Stem



- Polymer valve assembly with fixed nut
- Hold-open clip for continuous spraying
- Self-adjusting "duck" packing for lifetime leakproof seal
- Heavy-duty, mid-size, die cast zinc body

MFG. NO. 564GT SKU NO. 147926

Full Size Polymer Pistol Grip Nozzle



- Male hose threaded front for attaching accessories
- Polymer valve assembly with fixed nut
- Hold-open clip for continuous spraying
- Self-adjusting "duck" packing for lifetime leakproof seal

MFG. NO. 474GT SKU NO. 728496

Metal Body Select-A-Spray Nozzle

- 4-position dial for spray pattern selection
 - Full action - Gentle shower - Sharp stream - Flat spray
- All brass valve stem with permanent adjusting nut

MFG. NO. 584GT SKU NO. 306985

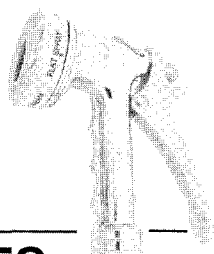

STRAIGHT NOZZLES



Solid Brass Twist Nozzle (Full Size)

- All brass valve stem
- Four large openings at nozzle tip for full flow
- Replaceable front and rear O-ring seals for leakproof shut-off
- Precise tip angle eliminates side spray

MFG. NO. 528GT
SKU NO. 122044

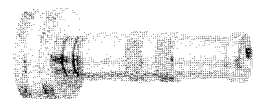

Solid Brass Twist Nozzle (Mid Size)

- All brass valve stem
- Four large openings at nozzle tip for full flow
- Front and rear O-ring seals for leakproof shut-off
- Precise tip angle eliminates side spray

MFG. NO. 529GT
SKU NO. 295063



Solid Brass Water Jet Nozzle

- Sprays a concentrated jet stream
- Ideal for cleaning driveways and walks
- Attaches to threaded front nozzles or hose end
- Heavy-duty solid brass construction

MFG. NO. 06BJGT
SKU NO. 122036

MENDERS & CONNECTORS

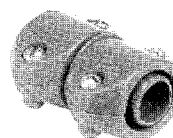

Hose Menders

- Hose mender fits all 5/8" or 3/4" rubber or plastic hose

MFG. NO. 01HMGT SKU NO. 141200

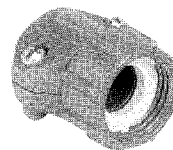

Female Replacement Hose Couplings

- Fits all 5/8" to 3/4" rubber or plastic hose

MFG. NO. 01FGT SKU NO. 141218

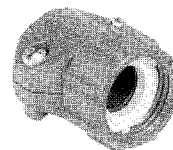

Male Replacement Hose Couplings

- Fits all 5/8" to 3/4" rubber or plastic hose

MFG. NO. 01MGT SKU NO. 141200



Hosemobile

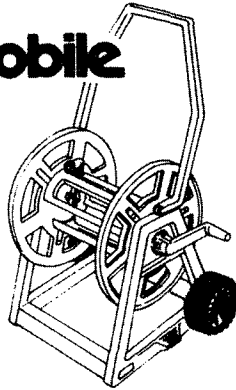

**Hosemobile® Deluxe
 Hose Reel Cart**

- Holds up to 200 feet of 5/8" hose
- Fast, easy snap-together assembly
- Includes Easylink® Faucet Adapter and Hose Connector for a snap-together, watertight connection

Model HRC 200

SKU NO. 750049

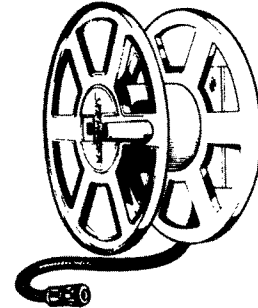

**Sidewinder™
 Wall-Mount Hose Reel**

- Holds up to 150 feet of 5/8" hose
- Reel detaches from the permanently mounted hub for easy storage
- Includes Easylink® Faucet Adapter and Hose Connector for a snap-together, watertight connection

Model SW 150

SKU NO. 750052

**Rubber Water Hose
 Abbot**

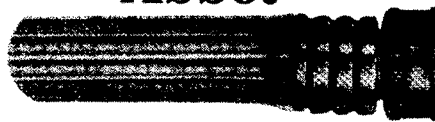

WATER PRESSURE 125#

(SERIES 1112)

APPLICATION

Service: Moderate pressure water hose assembly for contractors and industrial service.

SKU NO.	SIZE	LENGTH
751487	3/4"	25'
751490	3/4"	50'
751493	3/4"	75'

10Z Female & Male Couplings

Available in: 1/2", 5/8" and 3/4"

SKU NO.	MFG. NO.	SIZE
750489	1 Oz.	1/2"
750492	1 Oz.	5/8"

Color-Coded Clinch Couplings & Menders

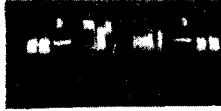

Brass Fittings

30Z Mender

Available in: 1/2", 5/8" and 3/4"

SKU NO.	MFG. NO.	SIZE
750516	3Z	1/2"
750522	3Z	3/4"
750519	3Z	5/8"



20Z Female Coupling

Available in: 1/2", 5/8" and 3/4"

SKU NO.	MFG. NO.	SIZE
750498	2 Oz.	1/2"
750504	2 Oz.	3/4"
750501	2 Oz.	5/8"



25Z Male Coupling

Available in: 1/2", 5/8" and 3/4"

SKU NO.	MFG. NO.	SIZE
750507	25Z	1/2"
750513	25Z	3/4"
750510	25Z	5/8"

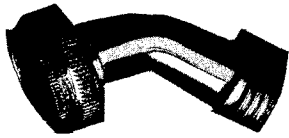

360S Metal Swivel Hose Connector
(45° angle)

SKU NO. 750531

Automatic Water Timer

Water timer delivers exact amount of water required, then shuts off. Easy to set for 35 to 1800 gallons, watering time from 20 minutes to 6 hours.

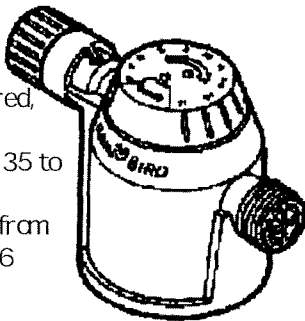

SKU NO. 750658

Super Flex Hose Connector

Heavy duty hose connector, with brass couplings. Eliminates kinks of hose at the faucet, maintains full flow at even a 90 degree angle, 60 O PSI burst pressure, drinking water safe.

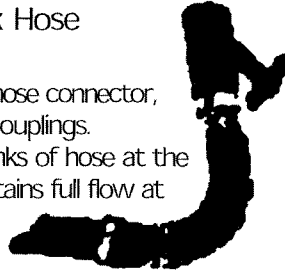

SKU NO. 750550

Rubber Water Hose Abbot

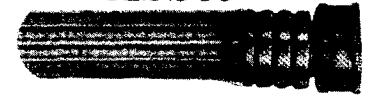

WATER PRESSURE 125#
(SERIES 1112)

APPLICATION

Service: Moderate pressure water hose assembly for contractors and industrial service.

SKU NO.	SIZE	LENGTH
751487	3/4"	25'
751490	3/4"	50'
751493	3/4"	75'



Hosemobile

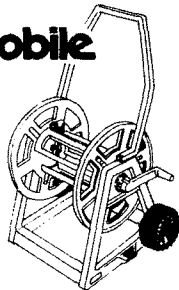

Hosemobile® Deluxe Hose Reel Cart

- Holds up to 200 feet of 5/8" hose
- Fast, easy snap-together assembly
- Includes Easylink® Faucet Adapter and Hose Connector for a snap-together, watertight connection

Model HRC 200

SKU NO. 750049

Sidewinder™ Wall-Mount Hose Reel

- Holds up to 150 feet of 5/8" hose
- Reel detaches from the permanently mounted hub for easy storage
- Includes Easylink® Faucet Adapter and Hose Connector for a snap-together, watertight connection

Model SW 150

SKU NO. 750052

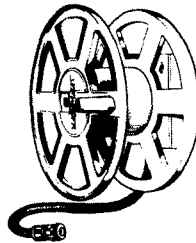

Steel Swing Mount Hose Reel

Holds 200' of 5/8" hose, easily detaches from bracket for storage, 2 lock positions: parallel or perpendicular to wall. Dual coated baked paint, extra long leader hose.

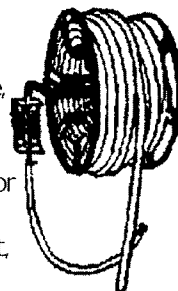

SKU NO. 750509

Standard Metal Hose Hanger

Baked enamel finish, welded 1-piece construction.

SKU NO. 141952

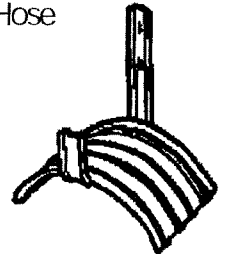

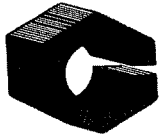

COUPLINGS COMPANY, INC.

BRASS GARDEN HOSE FITTINGS

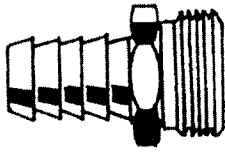

619 - HOSE BARB X MALE GARDEN HOSE

CAT NO.	SIZE	SKU NO.
619FJ	1/2 X 3/4	750511
619HJ	5/8 x 3/4	750514
691JJ	3/4 x 3/4	750517

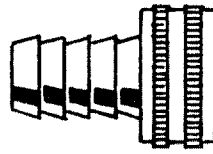

620 - HOSE BARB X FEMALE GARDEN HOSE SWIVEL NUT

CAT NO.	SIZE	SKU NO.
620FJ	1/2 X 3/4	750502
620HJ	5/8 x 3/4	750505
620JJ	3/4 x 3/4	750508

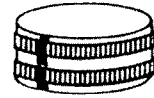

708 - CAP FEMALE GARDEN HOSE - SOLID TOP

CAT NO.	SIZE	SKU NO.
708J	3/4	140830

WHERE TO GET IT?
If you can't find it
in our catalog check
us out at our website:
addisononline.com
or e-mail us at:
abmsls@aol.com

10Z Female & Male Couplings

Available in: 1/2", 5/8" and 3/4"

SKU NO.	MFG. NO.	SIZE
750489	1 Oz.	1/2"
750492	1 Oz.	5/8"

Color-Coded Clinch Couplings & Menders

Brass Fittings

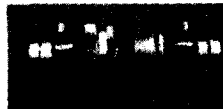

30Z Mender

Available in: 1/2", 5/8" and 3/4"

SKU NO.	MFG. NO.	SIZE
750516	3Z	1/2"
750522	3Z	3/4"
750519	3Z	5/8"



20Z Female Coupling

Available in: 1/2", 5/8" and 3/4"

SKU NO.	MFG. NO.	SIZE
750498	2 Oz.	1/2"
750504	2 Oz.	3/4"
750501	2 Oz.	5/8"

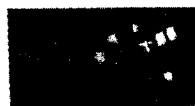

25Z Male Coupling

Available in: 1/2", 5/8" and 3/4"

SKU NO.	MFG. NO.	SIZE
750507	25Z	1/2"
750513	25Z	3/4"
750510	25Z	5/8"





Irrigation Products, Inc.

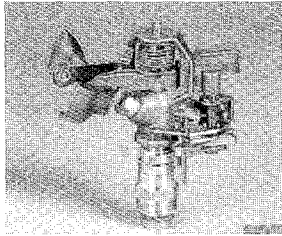

1/2" Brass Impact Sprinkler Head

- 1/2" MNPT connection
- Single brass 5/32" nozzle
- Full or part circle coverage
- Deflector and diffuser pin assembly
- Stainless steel air spring, trip spring, trip collars, & trip pin
- Anti-backsplash arm

MFG. NO. 55032 SKU NO. 754033



2" Adjustable Pop-Up Head

- Metal cap on Hard Top™ models reduce cap damage from lawn mowers, trimmers, and edgers
- Instant pattern nozzle easily adjusts from 25° to 360°.

MFG. NO. 54116 SKU NO. 75018



4" Adjustable Pop-Up Head

- Metal cap on Hard Top™ models reduce cap damage from lawn mowers, trimmers, and edgers
- Instant pattern nozzle easily adjusts from 25° to 360°.

MFG. NO. 54117 SKU NO. 754020

w/Hard Top MFG. NO. 54118
 SKU NO. 754022

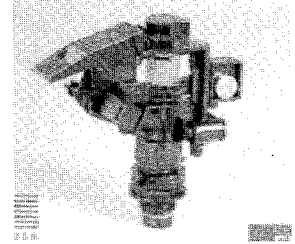

Orbit® Jet

- Use independently or to replace head for Satellite® pop-up impact
- 9/64" standard nozzle
- Deflector and diffuser pin assembly
- Anti-backsplash arm
- Brass-weighted driver arm
- 1/2" MNPT connection

MFG. NO. 55011 SKU NO. 754030

GEAR DRIVES



Saturn III™

- 40°-360° adjustable arc for fast, hassle-free adjustment
- 15' to 30' adjustable radius
- Proven gear drive quality
- Extra large filter screen traps debris to prevent clogging

MFG. NO. 55059 SKU NO. 754000



Voyager II™ Pop-Up

- Ideal for medium to large area coverage
- 40°-360° adjustable arc for fast, hassle-free adjustment
- Rubber cover
- Standard 3/4" FNPT inlet
- 25' to 45' adjustable radius
- Comes with pre-installed #7 nozzle

MFG. NO. 55060 SKU NO. 754002



Voyager II™ Canister

- Ideal for medium to large area coverage
- 40°-360° adjustable arc for fast, hassle-free adjustment
- Rubber cover
- Standard 1/2" FNPT bottom or side inlet (plug included)
- Comes with pre-installed #7 nozzle

MFG. NO. 55066 SKU NO. 754004



Voyager II™ Retrofit

- Easily replaces broken or worn out impact heads without digging up the existing canister
- Comes with 12 interchangeable nozzles, adjustment key, and snap on lid
- Replaces: WaterMaster® SuperJet™ and RainBird® Maxi-Paw™ & MiniPaw®

MFG. NO. 55067 SKU NO. 754006

Sprinkler Head Wrench

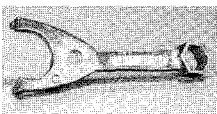

- Die-cast aluminum construction
- Use to install and remove sprinkler heads and insert nozzles

MFG. NO. 53027 SKU NO. 754027



Adjustable Shrub

- 1/2" FNPT inlet
- Nozzle easily adjusts from 25° to 360°
- Brass flow adjustment screw
- Filter prevents debris clog

MFG. NO. 54020 SKU NO. 754024



Cut-Off Riser

- Molded, polyethylene material
- Full (ASTM) standard threads
- Not for use under continuous pressure
- Cut to desired length

MFG. NO.	Size	SKU No.
37069	1/2" x 6"	754008
37169	1/2" x 12"	754010
37113	3/4" x 6"	754012
37114	1/2" x 3/4" x 6"	754014
37126	1/2" x 6" MxM	754016

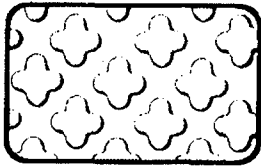

ALUMINUM & GALVANIZED SHEETS

SKU NO.	MFG.	SIZE	TYPE
.019" THICKNESS			
803624	57794	2' X 3'	PLAIN MILL
803630	57810	2' X 3'	LEATHERGRAIN MILL
803627	57000	3' X 3'	PLAIN MILL
803633	57026	3' X 3'	LEATHERGRAIN MILL



PERFORATED ALUMINUM SHEETS

SKU NO.	MFG.	SIZE	TYPE
.020" THICKNESS			
803636	57042	2' X 3'	CLOVERLEAF MILL
803645	57067	2' X 3'	LINCAINE MILL
803657	57083	2' X 3'	UNION JACK MILL
803637	57109	2' X 3'	CLOVERLEAF ALBRAS
803648	57125	2' X 3'	LINCAINE ALBRAS
803660	57141	2' X 3'	UNION JACK ALBRAS
803639	57166	3' X 3'	CLOVERLEAF MILL
803651	57182	3' X 3'	LINCAINE MILL
803663	57208	3' X 3'	UNION JACK MILL
803642	57240	3' X 3'	CLOVERLEAF ALBRAS
803654	57265	3' X 3'	LINCAINE ALBRAS
803666	57281	3' X 3'	UNION JACK ALBRAS

expanded steel sheet 24" x 30"

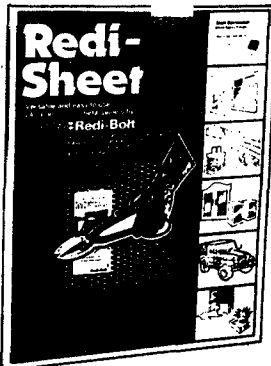

SKU NO.	MFC NO.	ITEM
853125	74301	white
853128	74401	silver

Our catalog does not contain everything in our inventory. If there are products you do not find that are related to those in this catalog call 437-1288 so that we may assist you.

WINDOW SYSTEM II

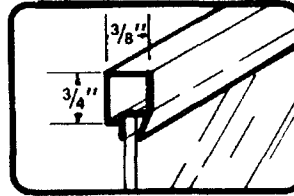

DOWN WINDOW FRAME SECTION

3/4" WIDE X 3/8" THICK FOR 1/8" THICK MATERIAL

SKU NO.	MFG.	SIZE
803723	36004	72" MILL
803726	36012	96" MILL

SCREEN WINDOW SYSTEM II

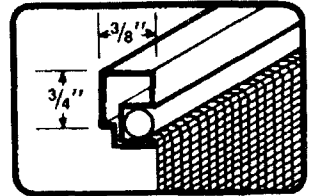

SCREEN FRAMES 3/4" WIDE X 3/8" THICK

SKU NO.	MFG.	SIZE
803711	36061	72" MILL
803714	36079	96" MILL
803717	36087	72" WHITE
803720	36095	96" WHITE

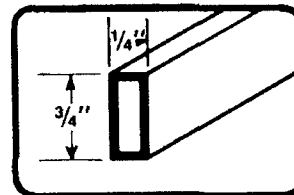

CENTER BRACES 3/4" WIDE X 1/4" THICK

SKU NO.	MFG.	SIZE
803708	36129	72" MILL

SCREEN FRAME CORNER LOCKS

SKU NO.	MFG.	COLOR	4 PER PKG.
803729	36236	WHITE	

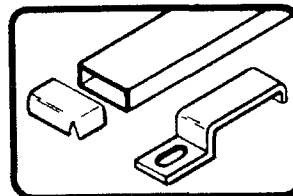
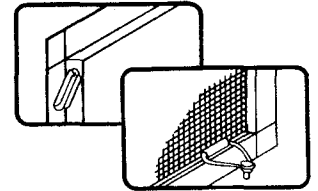

CENTER BRACE INSERT

SKU NO.	MFG.	2 PER PKG.
803732	36335	

TACKLESS CARPET STRIP

WOOD NAIL

SKU NO.	MFG.	SIZE
802395	75176	48" BULK

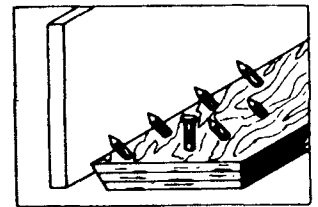



Staralum®

Aluminum

Bright

18 x 16 mesh .011 diam

Standard roll—

100 linear feet

SKU No.	Width In.	Square ft per roll	Mesh (.011 diam)
751191	24	200	18 x 16
751194	26	216 ² / ₃	18 x 16
751197	28	233 ¹ / ₃	18 x 16
751200	30	250	18 x 16
751203	32	266 ² / ₃	18 x 16
751206	36	300	18 x 16
751209	42	350	18 x 16
751212	48	400	18 x 16
751215	60	500	18 x 16
751218	72	600	18 x 16



Starglas®

Fiberglass

Gray

18 x 16 mesh .011 diam

Standard roll—

100 linear feet

SKU No.	Width In.	Square ft per roll	Mesh (.011 diam)
751221	24	200	18 x 16
751224	26	216 ² / ₃	18 x 16
751227	28	233 ¹ / ₃	18 x 16
751230	30	250	18 x 16
751233	32	266 ² / ₃	18 x 16
751236	36	300	18 x 16
751239	42	350	18 x 16
751242	48	400	18 x 16
751245	60	500	18 x 16
751248	72	600	18 x 16



Starbrite®

Commercial Bronze

Bright Finish

18 x 14 mesh .011 diam

Standard roll—

100 linear feet

SKU No.	Width In.	Square ft per roll	Mesh (.011 diam)
751251	24	200	18 x 14
751254	36	300	18 x 14
751257	48	400	18 x 14

WIRESCREEN INSTALLATION TOOLS



For Screen Spline And Drop-In Glazing

SKU NO.	PACKED
700112	EACH



SKU NO.	MFG NO.	SIZE
806770	SR-130	1/8"
806772	SR-140	9/64"
806773	SR-156	5/32"
806775	SR-170	11/64"
806776	SR-200	13/64"
806778	SR-230	15/64"
806779	SR-250	1/4"



The fastest and easiest way for screen spline and drop-in glazing. To replace broken screens or broken windows in aluminum frames.

SKU NO.	MFG NO.
806782	S-100

Our catalog does not contain everything in our inventory. If there are products you do not find that are related to those in this catalog call 437-1288 so that we may assist you.

OVERSIZE STORAGE BAGS



CB-36 Regular
5 bags 3' x 5'

SKU NO.	SIZE
750069	36" x 60"



CB-40 Large
4 bags 40" x 6'

SKU NO.	SIZE
750071	40" x 72"



CB-45 Giant
3 bags 45" x 8'

SKU NO.	SIZE
750073	45" x 96"



Warp's

SKU NO.	MFG NO.	SIZE	MIL THICKNESS	PACK
750048	FB26-100	26 Gal	1 1/4	100
750051	FB30-100	30 Gal	1 1/2	100
750054	FB33-100	33 Gal	1 1/2	100
750057	FB55-50	55 Gal	1 3/4	50
750063	HB33-60	33 Gal	2 1/2	60
750060	HB55-30	55 Gal	3	30

CLEAR POLYFILM

SKU NO.	MFG. NO.	SIZE	GAUGE
100001	4CH350	3' x 50'	4 MIL
100017	4CH10	10' x 25'	4 MIL
100018	4CH1050	10' x 50'	4 MIL
100032	4CH15	15' x 25'	4 MIL
100033	4CH1550	15' x 50'	4 MIL
100037	4CH20	20' x 25'	4 MIL
100038	4CH2050	20' x 50'	4 MIL
100082	6CH10	10' x 25'	6 MIL
100097	6CH15	15' x 25'	6 MIL
100102	6CH20	20' x 25'	6 MIL

BLACK POLYFILM

SKU NO.	MFG. NO.	SIZE	GAUGE
100147	4CH10-B	10' x 25'	4 MIL
100148	4CH1050-B	10' x 50'	4 MIL
100162	4CH15-B	15' x 25'	4 MIL
100163	4CH1550-B	15' x 50'	4 MIL
100167	4CH20-B	20' x 25'	4 MIL
100168	4CH2050-B	20' x 50'	4 MIL

CLEAR POLYFILM

SKU NO.	MFG. NO.	SIZE	GAUGE
100015	PC8	8' x 100'	3 MIL
100020	PC10	10' x 100'	3 MIL
100025	PC12	12' x 100'	3 MIL
100035	PC16	16' x 300'	3 MIL
100040	PC20	20' x 100'	3 MIL
100065	6 X 3	3' x 100'	6 MIL
100070	6 X 4	4' x 100'	6 MIL
100075	6 X 6	6' x 100'	6 MIL
100080	6 X 8	8' x 100'	6 MIL
100085	6 X 10	10' x 100'	6 MIL
100090	6 X 12	12' x 100'	6 MIL
100100	6 X 16	16' x 100'	6 MIL
100105	6 X 20	20' x 100'	6 MIL
100110	6 X 24	24' x 100'	6 MIL
100120	6 X 32	32' x 100'	6 MIL
100125	6 X 40	40' x 100'	6 MIL
100266	10 x 206	20' x 100'	6 MIL

BLACK POLYFILM

SKU NO.	MFG. NO.	SIZE	GAUGE
100145	PC8-B	8' x 100'	3 MIL
100150	PC10-B	10' x 100'	3 MIL
100155	PC12-B	12' x 100'	3 MIL
100165	PB16-B	16' x 100'	3 MIL
100170	PC20-B	20' x 100'	3 MIL
100169	6 x 1-B	12' x 300'	6 MIL
100205	6 x 6-B	6' x 100'	6 MIL
100210	6 x 8-B	8' x 100'	6 MIL
100215	6 x 10-B	10' x 100'	6 MIL
100220	6 x 12-B	12' x 100'	6 MIL
100230	6 x 16-B	16' x 100'	6 MIL
100235	6 x 20-B	20' x 100'	6 MIL
100240	6 x 24-B	24' x 100'	6 MIL
100250	6 x 30-B	30' x 100'	6 MIL
100255	6 x 40-B	40' x 100'	6 MIL



REINFORCED POLYFILM

SKU NO.	MFG. NO.	SIZE
100260	RE12	12' x 100'
100263	RE24	24' x 100'

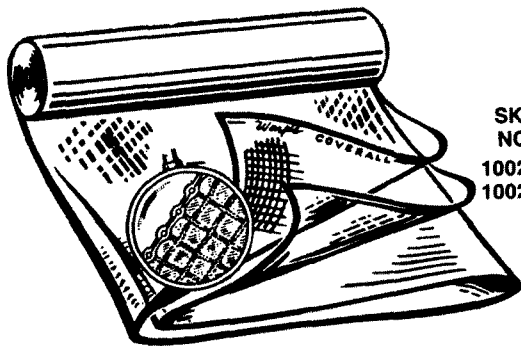

FLAME RETARDANT POLY FILM

SKU NO.	MFG. NO.	MIL	SIZE
100269	6X20FR	6	20' x 100'

WHITE POLY FILM

SKU NO.	TYPE	SIZE
100261	4 mil	20' x 100'



Lord & Hodge, Inc.

HANDI-GROMMET KITS AND REFILLS

For professional grommet repairs to tents, sails, awnings, patio and pool covers, shower curtains and boat covers. Instructions are easy to follow. Tools included are cutting block, hole cutter, inserting punch and die. Handi-Grommet Kits are carded,

SKU NO.	Catalog No.-Size	Grommet Inside Diameter	Grommets per Kit
750983	1073A-0	1/4"	48
750985	1073A-2	3/8"	24
750986	1073A-4	1/2"	24



PACKED 24
Refill
Grommets

SKU NO.	MFG NO.
750988	1074-0
750989	1074-2
750991	1074-4

Double Coated Poly-Woven Tarp

SKU NO	MFG NO	COLOR	SIZE
750984	BLUE	BLUE	5' X 7'
750987	BLUE	BLUE	8' X 10'
750990	BLUE	BLUE	9' X 12'
751093	BLUE	BLUE	12' X 12'
750993	BLUE	BLUE	12' X 20'
750996	BLUE	BLUE	16' X 20'
750999	BLUE	BLUE	20' X 20'
751095	BLUE	BLUE	20' X 30'
751094	BLUE	BLUE	25' X 40'
751096	BLUE	BLUE	40' X 40'
751097	BLUE	BLUE	30' X 50'
751098	BLUE	BLUE	40' X 60'
651745	770068	BROWN	6' X 8'
654803	770810	BROWN	8' X 10'
656634	771012	BROWN	10' X 12'
648485	771020	BROWN	10' X 20'
651737	771220	BROWN	12' X 20'
656655	771520	BROWN	15' X 20'
648501	771530	BROWN	15' X 30'
205260	772030	BROWN	20' X 30'
205263	773050	BROWN	30' X 50'



SNAP FASTENER KITS AND REFILLS

Install or replace snap fasteners quickly and effectively with the Snap Fastener Kit. Six sets of brass nickel plated snaps and setting tool are packaged for canvas or cloth (#1100). Screw studs (#1110) may be ordered for mounting to hard surfaces. Refills contain six sets of fasteners (without tools)

SKU NO.	Catalog Number	Stud Style	Sets per Kit	SKU NO.	Refill Fasteners
750992	1100	Canvas	6	750995	1100A
750994	1110	Screw	6	750997	1110A

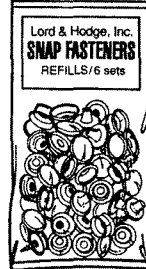

SCREW TYPE

Packed 6

SKU NO.	MFG. NO.
750997	1110A

CLAMP TYPE

Packed 6

SKU NO.	MFG. NO.
750995	1100A

GOSPORT THE KING OF TARPAULINS

"MAJESTIC STYLE" with

ROPE-IN-HEM

(THE FIRM-TOUGH EDGE)

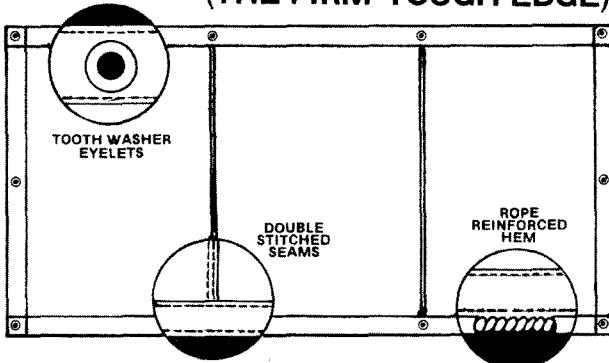

Made of quality Canvas Duck and sealed with our special CANVAK Treatment to make our tarps absolutely water and mildew resistant. All seams are double stitched for added strength. For the customer who wants a firm edged tarpaulin that deters wear. The hem is 1 1/2" wide with the rope on the outer edge of a 1 1/2" turned under hem with two (2) rows of stitching. The tooth washer grommet is placed between the two rows of stitching, locating on the joining seams and 3-4 feet apart. The thread used throughout is a heavy duty, rot resistant type. Individual tarps are packaged attractively with a descriptive information label.

SKU NO.	MFG NO.	SIZE	CANVAS TARP
751029	101210GB	10' x 12'	10 oz.
751032	101410GB	10' x 14'	10 oz.
751035	101610GB	10' x 16'	10 oz.
751038	121410GB	12' x 14'	10 oz.
751041	121610GB	12' x 16'	10 oz.
751044	141610GB	14' x 16'	10 oz.
751047	152010GB	15' x 20'	10 oz.
751050	162410GB	16' x 24'	10 oz.
751053	202010GB	20' x 20'	10 oz.
751056	203010GB	20' x 30'	10 oz.
751017	5710GB	5' x 7'	10 oz.
751020	6810GB	6' x 8'	10 oz.
751023	7910GB	7' x 9'	10 oz.
751026	81010GB	8' x 10'	10 oz.



FENCE POSTS

Polyester Coated
Over Steel

For use with lighter
weight fencing

Special channel
construction
for maximum
strength

Heights:
3',4',5',6'



SKU NO.	MFG. NO.	HEIGHT
751143	165236	36"
751146	165248	48"

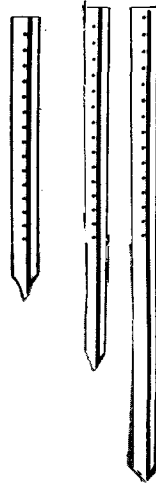
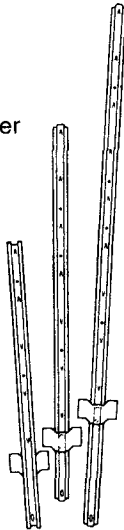

STEEL STAKES

SKU NO.	MFG. NO.	LENGTH
801137	UP-5	20"
801140	UP-5	26"
801143	UP-5	36"

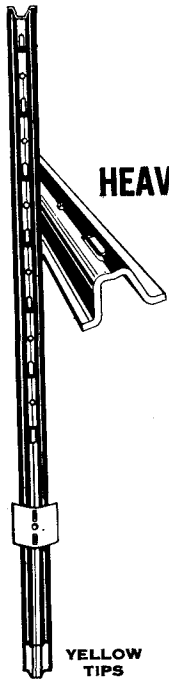

HEAVY DUTY

Universal
MULTI-PURPOSE
FENCE POSTS

HEAVY DUTY

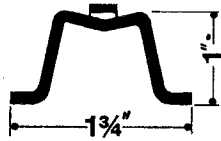

4 SIZES
5, 6, 7 and 8 ft.
13 Gauge Steel
Green finish
with yellow tips

SKU NO.	LENGTH
808124	5 FT.
808127	6 FT.
808130	7 FT.
808133	8 FT.

YELLOW TIPS

ANCHORS EARTH

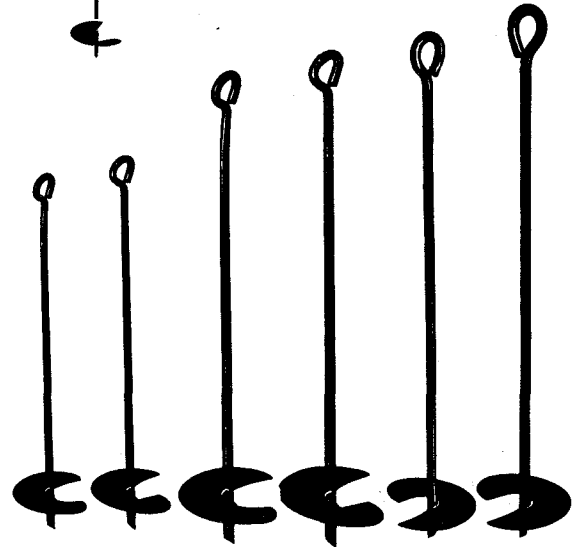

SKU NO.	MFG. NO.	SIZE	ROD
139527	404	40"	1 1/16"
139535	604	48"	1 1/16"
180471	315SA	15"	KEEP STAKE
139519	330SA	30"	7/16"



Universal POST DRIVER

The SAFE easy way to install posts.
24" long weighs 22 pounds

SKU NO. 808136



HEX NETTING



Handy 25 ft. Rolls

Protect newly seeded lawns
 Support for vegetables and flower vines
 Protect gardens from predators

SKU NO.	MFG. NO.	LENGTH
751423	012035	18" HEX
751426	012035	24" HEX
751429	012035	36" HEX
751431	012035	48" HEX
751433	012035	60" HEX
751436	012035	72" HEX

GILBERT & BENNETT REDI-ROLLS HARDWARE CLOTH

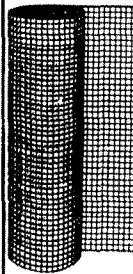
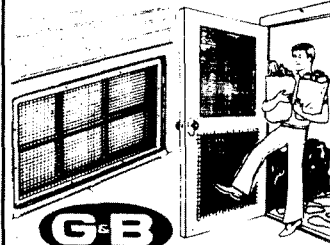

- Handy lengths for ready use.
- Re-galvanized for durability.
- Keep a roll or two in the workshop for unexpected projects or repairs.
- Available in 1/2" mesh or 1/4" mesh.

SKU NO.	MFG. NO.	LENGTH
751179	453035	1/2" SQ. x 24"
751182	453035	1/2" SQ. x 30"
751185	453035	1/2" SQ. x 36"
751188	453035	1/2" SQ. x 48"
751155	453066	1/4" SQ. x 24"
751158	453066	1/4" SQ. x 30"
751161	453066	1/4" SQ. x 36"
751164	453066	1/4" SQ. x 48"
751167	453071	1/8" SQ. x 24"
751170	453071	1/8" SQ. x 30"
751173	453071	1/8" SQ. x 36"
751176	453071	1/8" SQ. x 48"

GREEN POLY GENERAL PURPOSE FENCING

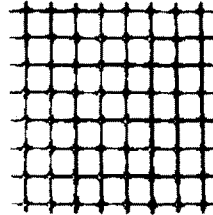

Polygrid, 4' x 50' fencing. Lightweight, safe for children and animals. Makes an attractive perimeter fence or trellis material for shelter of trees, shrubs and flowers.

SKU NO.	MFG. NO.	LENGTH
758755	BX2070149P	48" x 50'

RABBIT GARD

Protect your Garden From Nibblers!

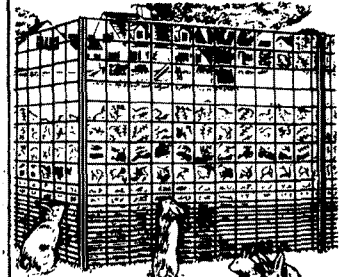

- Designed to keep out rabbits and other small animals.
- Bottom 16" has 12 - 1" plus 2 - 2" horizontal openings. Balance 4" x 4" mesh.
- 50' rolls 28" and 40" high.

SKU NO.	MFG. NO.	LENGTH
751125	272010	28" x 50'
751128	272010	40" x 50'

ALL SEASON SAFETY FENCE

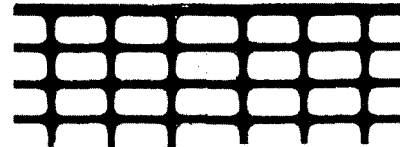

High density polyethylene visibility orange safety fencing. Also can be used for effective snow control. Openings 1 1/8" x 2 1/4" Approximate 50% porosity.

SKU NO.	Size and Length
751333	48" x 50'

TEE POST

SKU NO	SIZE
751469	5'
751472	6'
751478	7'
751481	8'

CHAIN LINK ACCESSORIES

2-3/8" Walk Gate Set



Includes: drop fork latch assembly, 2 hinge assemblies

SKU NO. 755212

2-3/8" Drive Gate Set



Includes: 4 hinge assemblies

SKU NO. 755212

6-1/2" Chain Link Cut Tie (30 pk.)

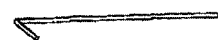

11 gauge cut tie.

SKU NO. 755316

Chain Link Tension Band 2-3/8"

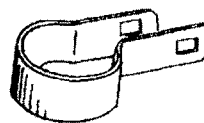

Tension band, recommended 4 per bar.

SKU NO. 755300

Chain Link Brace Band 2-3/8"



Use 1 per bar..

SKU NO. 755302

OD Chain Link Post Cap 2-3/8"

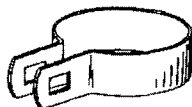

OD Terminal post cap.

SKU NO. 755306

1-3/8" OD Cup for Chain Link Rail

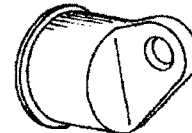

OD cup for top rail.

SKU NO. 755304



Loop Cap 1-5/8" Post and 1-3/8" Rail

Loop cap for 1-5/8" line post and 1-3/8" top rail.

SKU NO. 755308

5/8" x 47" Chain Link Tension Bar

5/8" W x 47" L tension bar, 3/16" thickness.

SKU NO. 755310



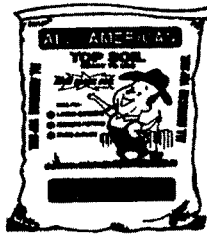

40 lb. Top Soil

MFG. NO.
020RDC01

SKU NO.
732370

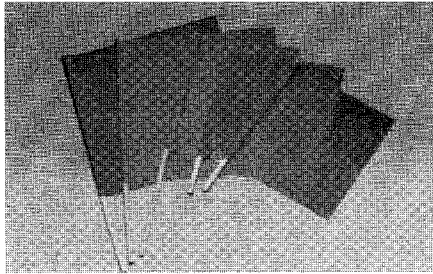

SAFE-T-FLAGS

18" x 18" w/24" handle.

MFG. NO.
5130

SKU NO.
701555

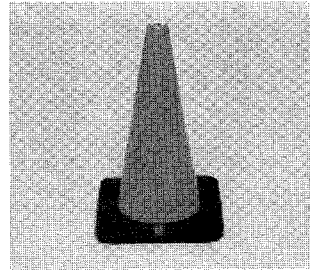

ORANGE SAFE-T-CONE

MFG. NO.	SKU NO.	SIZE
18PO	870088	18"
28PO	870091	28"
36PO	870094	36"

**Multi Crush
 Aluminum Can Compactor**

SKU NO
587816

MFG NO.
W7-24

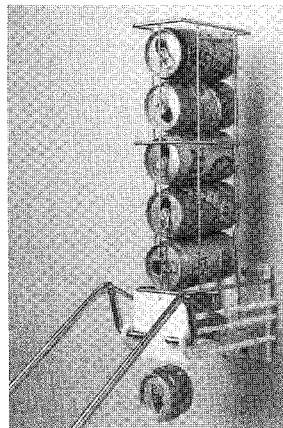
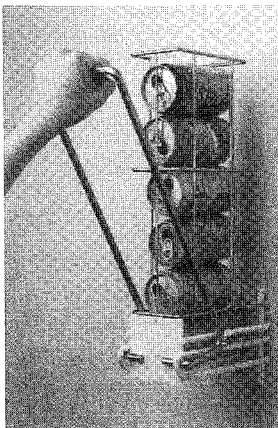

- Loads up to six standard size aluminum cans at once.
- Instantly flattens cans down to about 1"
- Automatically ejects cans into your recycling container.
- Crushed cans save five times as much storage and transport space.
- Makes recycling easy and fun.
- Sturdy all-steel construction.

GERMAIN'S®

Germain's TWIST-EMS® Ties and related products are a unique assortment of highly practical items that create maximum impulse sales and fast turn-over. TWIST-

EMS® ties, now super-laminated for quality, are "the original" all-purpose handy tie with positive-locking ability for home, garden and hundreds of other uses.

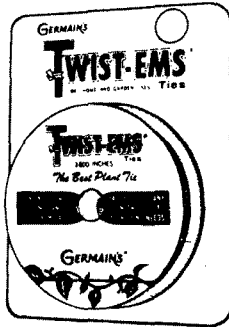

TWIST-EMS® TIES

T-15—5/32" x 150 ft. roll plastic tie with wire for long lasting tying.

SKU NO. 750262

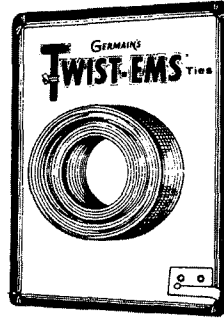

TWIST-EMS® TIES

T-17—5/32" x 100 ft. continuous roll with cutter attached. A handy all-purpose tie.

SKU NO. 750260

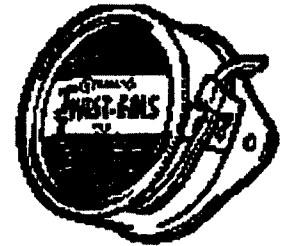

TWIST-EMS® TIES

T-001 - 100' plastic sturdy twist tie with cutter, for home and garden use. A handy tie for vegetables, shrubs and flowers.

SKU NO. 750262

OPEN STOCK HITCH PINS



HITCH PIN

ENDERES TOOLS

When ordering Hitch Pin Clips for Enderes Hitch Pins, order the following:

SKU Number	Pin #	Clip #
850189	HO	#11
850186	H1 thru H5	#9

SKU Number	Stock Number	Description	Working Length	Std. Pkg.
850159	0355	H-00	3/8" x 3"	1
850162	0357	H-0	1/2" x 3-1/2"	1
850168	0359	H-1	5/8" x 4-1/2"	1
850171	0361	H-2	3/4" x 6"	1
850174	0363	H-3	7/8" x 6"	1
850177	0365	H-4	1" x 6"	1
850183	0367	H-5	1-1/8" x 7"	1

SMOOTH GALVANIZED WIRE - FOR GENERAL SECURING & LANDSCAPING

SKU NO	GAUGE	FEET/ROLL
751460	9	190
751463	12.5	380
751466	14	580
751487	16	960

Taylor
 PRODUCTS

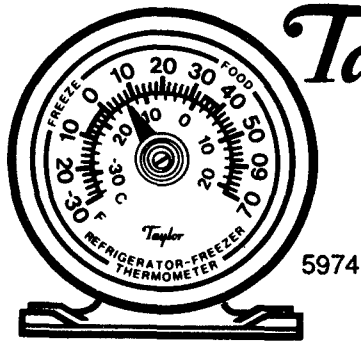

5974 Valuline™ Refrigerator/Freezer Thermometer
 New rotating case design for more secure hanging or standing on refrigerator racks. 2 1/2" x 2 3/4". F° and C° scale with refrigerator and freezer zones. Stainless steel.

SKU NO. 750981

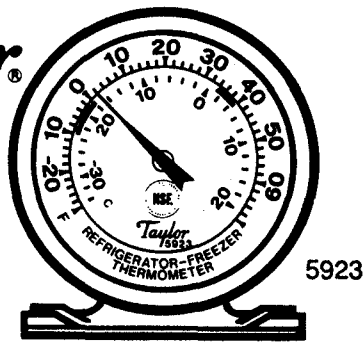

5923 Dial Refrigerator/Freezer Thermometer
 Hi-visibility Bi-Therm® dial graphics and a unique hang-or-stand rotating case design. All stainless steel construction with shatterproof plastic crystal meets National Sanitation Foundation specifications. Food storage and freezing zone markings. Product dimensions are 2 1/2" x 2 3/4". Temperature range is -30°F to 70°F with equivalent Celcius.

SKU NO. 750942

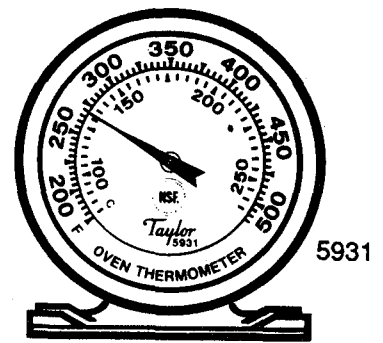

5931 Dial Oven Thermometer
 New swivel case design allows for more secure hanging or standing on oven racks. Hi-visibility Bi-Therm® dial graphics for easier readings. All stainless construction with tempered glass crystal to meet National Sanitation Foundation specifications. Product is 2 1/2" x 2 3/4" with a range of 175°F to 500°F with equivalent Celcius.

SKU NO. 750324

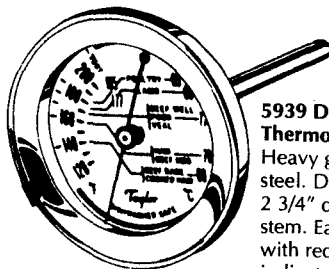

5939 Dial Meat Thermometer
 Heavy gauge stainless steel. Dishwasher safe. 2 3/4" dial with 5 1/2" stem. Easy to read dial with red pre-set indicator. F° & C°. Zoned dial with National Livestock & Meat Board recommended temperatures.

5939

SKU NO. 750972

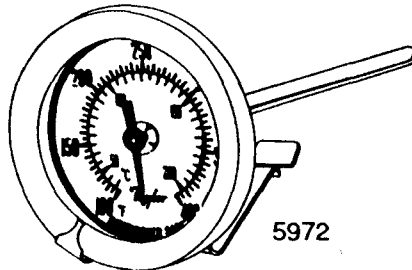

5972 Valuline™ Candy/Deep-Fry Thermometer
 Stainless steel. Dial type. 2 1/4" diameter. 5 1/2" slim stem. Pre-set indicator for quick, easy reading. F° & C°. Adjustable pan clip. Dishwasher safe.

5972

SKU NO. 750969

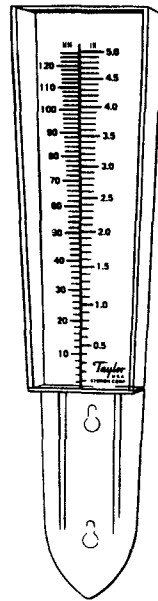

2702

2702 Clear-Vu™ Rain Gauge
 Tapered spear end for ground or post mount. Measures 5" or 127mm of rainfall. 12 1/2" lg. Collector opening 2 1/4" x 1 1/4".

SKU NO. 750939

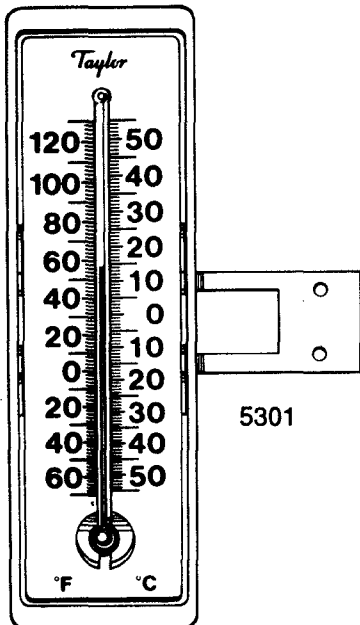

5301

5301 Hi-Lite™ Window Thermometer
 Recessed tube, 7 5/8" x 2 1/4". Aluminum bracket. Easy-to-read, large numerals. F° & C°

SKU NO. 750948

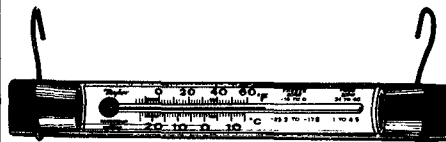

5977

5977 Refrigerator/Freezer Thermometer
 Simple, economical clear tube design for monitoring temperatures inside refrigerator or freezer. Compact to hang or lay on rack. Cold zones. Non-toxic filling. F° & C°.

SKU NO. 750933

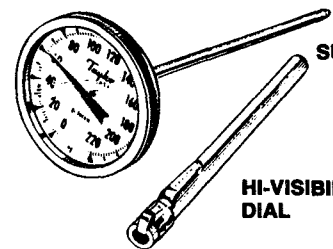

SUPERIOR GRADE

HI-VISIBILITY DIAL

1" Dial with 5" pointed stem. Unbreakable polycarbonate crystal all stainless steel construction.

SKU NO.	MFG NO.	RANGE
750975	6071-1	-40° to 120°F
750978	6072-1	0° to 220°F

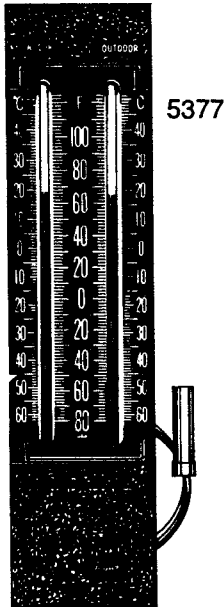

5377 Biltmore
 Black pebble-grained finish case. Read indoor and outdoor temperatures indoors. Recessed tubes 9 3/4" x 2 1/4". F° & C° scales.

SKU NO. 750936

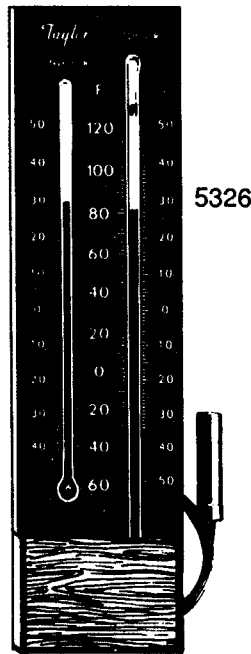

5326 Grove Park
 Read outside and inside temperatures indoors on same F° & C° scales. Molded brown with a wood grain finish. Bottom insert for logos or copy in premium applications. 9" x 2 1/2".

SKU NO. 750252

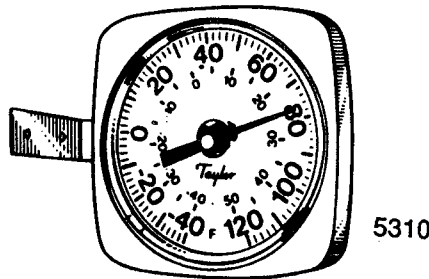

5310 6" Dial Window Thermometer
 Bright, clean design for easy reading of outdoor temperatures through a window. Compact 6" dial area with both F° and C° numerals. All rust proof materials including secure, multi-angle window bracket.

SKU NO. 750954

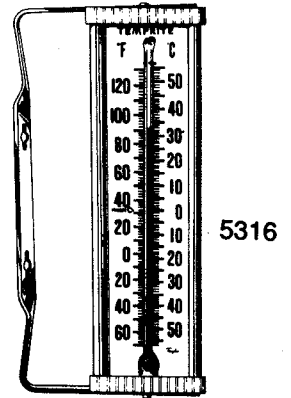

5316 Temprite® Window Thermometer
 Aluminum scale. Large easy-to-read numerals. Non-rusting aluminum bracket. F° & C°. 8".

SKU NO. 750291

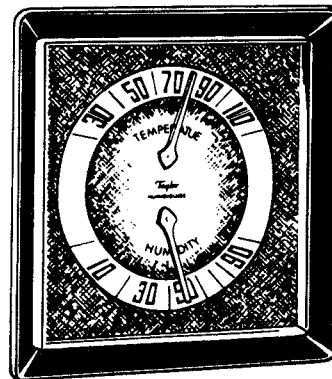

5502 Ashton Humidiguide® Hygrometer Thermometer
 Brushed aluminum dial in light gold, framed by a 4" square brown pebble-grained case. Range 20°F-120°F and 0%-100% rel. humidity.

SKU NO. 750930

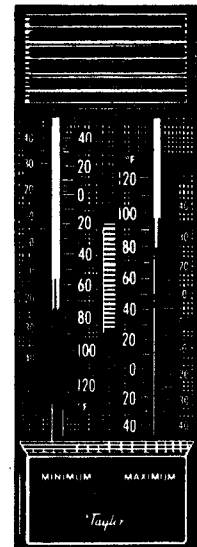

5460 Maximum-Minimum Thermometer
 Thermometer registers high and low readings from last setting. Modern design with black pebble-grain finish. Pushbutton reset. F° & C° scales. 8 3/4" x 2 3/4".

SKU NO. 750957

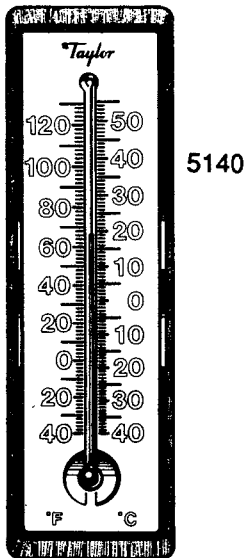

5140 Comforter™ Wall Thermometer
 Attractive wall thermometer blends with any decor. Wood grained frame finish. Bold numbers and graduations. F° & C°. 7 5/8" x 2 1/4".

SKU NO. 750963

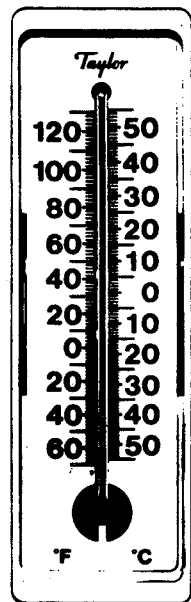

5152A-5 Wall Thermometer
 Ideal for energy conservation in the home. F° & C°. 7 5/8" x 2 1/4". Attractive almond decorator color with easy-reading numerals and graduations.

SKU NO. 750966

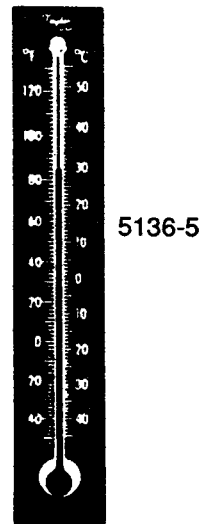

5136-5 Wall Thermometer
 High impact plastic cannot rust. Use indoors or outdoors. F° & C°. 6" x 1 1/8".

SKU NO. 750960

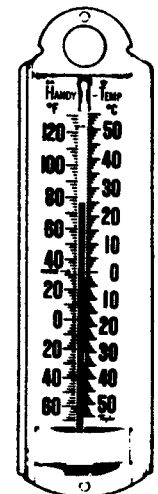

5135 Handy-Temp™ Wall Thermometer
 Indoor or outdoor use. All aluminum, can't rust. F° & C°. 8 7/8".

SKU NO. 750945

Plain Toe Knee Boots



- 16" one piece molded PVC construction
- 100% leak proof protection
- Cushion insole, steel shank, cleated outsole

SKU NO.	MFC NO.	BOOT SIZE
751015	7210-8	8
751016	7210-9	9
751018	7210-10	10
751019	7210-11	11
751021	7210-12	12
751022	7210-13	13

17" Yellow Strap Boot



- Top strap pull over boot
- Wide throat for easy on/off
- Net lining

SKU NO.	MFC NO.	BOOT SIZE
751060	7275-8	8
751061	7275-9	9
751063	7275-10	10
751064	7275-11	11
751066	7275-12	12
751067	7275-13	13

5-Buckle Boot



- 14" high black rubber over the shoe
- Stretch net lining
- Heavy duty cleated outsole

SKU NO.	MFC NO.	BOOT SIZE
751078	7260-8	8
751079	7260-9	9
751081	7260-10	10
751082	7260-11	11
751084	7260-12	12
751085	7260-13	13

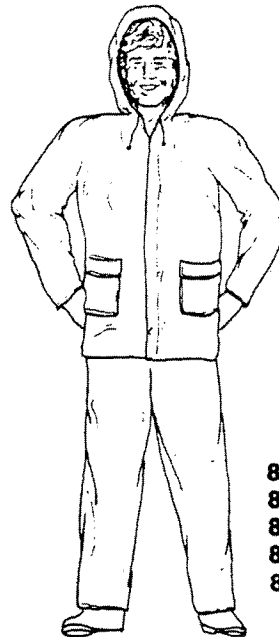

HEAVY DUTY 3-PIECE RAINSUIT

SKU NO.	MFG NO.	SIZE
809291	801-L	Large
809293	801-M	Medium
809295	801-S	Small
809289	801-XL	Ex-Large
809298	801-XXL	XX-Large

WATER HAULER.



- Heavy-duty plastic construction.
 - Snap vent for smooth pouring.
 - Available in Brilliant Blue.
 - Full 6-year warranty.
 - Model No. 1166 - 6-Gallon.
- SKU NO. 750885

KEROSENE CAN

- Won't rust ... resists corrosion.
- Large, easy-to-grip handle.
- Flexible spout.
- Attached vent cap.
- Built-in fuel filter.



Model No. 1151.
 SKU NO. 750882

COOLER SPOUT AND CAP
 SKU NO. 750951

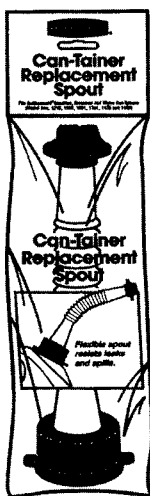

Can-Tainer Replacement Spout
 fits all Gasoline, Kerosene and Water Can-Tainers
 Model No. 0706.

SKU NO. 750950

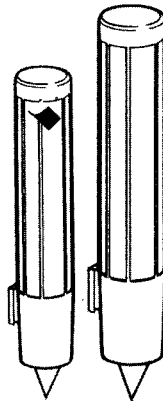

Cup Dispenser – 7 oz.
 Model No. 8257
 SKU NO. 750956

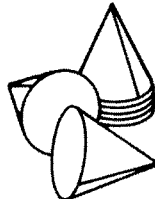

Cone Paper Cups – 7 oz.
 Model No. 0157
 SKU NO. 750893

GAS HANDLER.

- Won't rust.
- Large to-grip handle.
- Flexible spout fits unleaded tanks.
- Safety Red color.

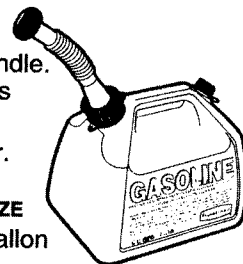

SKU NO.	Model	SIZE
870141	1251	5-Gallon

2 GALLON

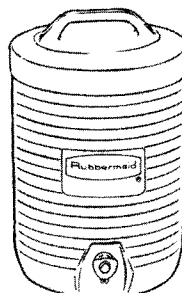

SKU NO. 551119 MFG NO. 1692-01-11

3 GALLONS TO GO.

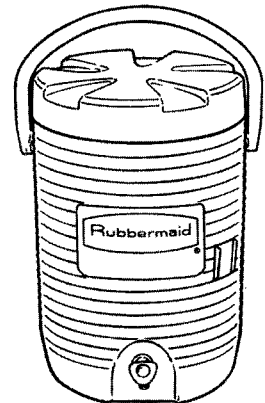

- Heavy-duty construction resists dents and corrosion.
- Screw-tight insulated lid.
- Bail handle for easy carrying.
- Recessed fast-flow faucet for easy pouring.
- Attached cup dispenser bracket.

Model No. 1683.
 SKU NO. 750870

10 GALLON

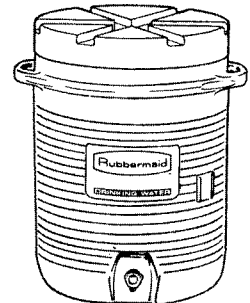

No. 1610



- Quikgrip® handles.

SKU NO. 750876

5-GALLON

- Model No. 1685.

SKU NO. 750873

	SCOOP, POLISHED CAST ALUMINUM, 10" X 3 ³ / ₈ ", LABELED SKU NO. 705548	502
	SCOOP, AS ABOVE, 12 ³ / ₄ " X 4 ³ / ₈ " SKU NO. 705551	503
	SCOOP, AS ABOVE, 14 ¹ / ₄ " X 5 ¹ / ₄ " SKU NO. 705554	504
	SCOOP, AS ABOVE, 15 ¹ / ₂ " X 5 ³ / ₄ " SKU NO. 705557	505
	SCOOP, POLISHED CAST ALUMINUM, 9 ¹ / ₄ " X 3 ¹ / ₈ " LABELED SKU NO. 705560	511

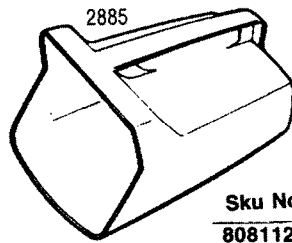

Rubbermaid® Scoop

SKU No.	No.	Description
808112	2885	64 oz.
		Color: White

WASTE RECEPTACLES AND PLASTIC CONTAINERS

SKU	MFG#	DESCRIPTION
890110	2361	PAPER TOWEL HOLDER ALMOND
606000	2820	SHOWER CADDY
751102	3091	1 QUART SERVIN SAVER BOTTLE
751103	3092	2 QUART SERVIN SAVER BOTTLE
751109	1345EV	45 GAL WHEELED REFUSE CONTAINER
751077	2892EV	20 GAL ROUGHNECK REFUSE CONTAINER
751080	2894EV	32 GAL REFUSE CONTAINER 32-1/2" HIGH



GALVANIZED PAILS

Hot dipped galvanized steel construction. Reinforced wire rim — 26-31 gauge material.

HOUSEHOLD TYPE

Sku No. Model	Size	Dimensions		
		Top	Bottom	Height
377242 1208	8 Qt.	9 ³ / ₄ "	7 ¹ / ₂ "	8 ³ / ₈ "
376715 1210	10 Qt.	10 ¹ / ₄ "	8 ¹ / ₂ "	9 ¹ / ₄ "



UTILITY BASKET

Economical 1 bushel measure - manufactured of galvanized sheet steel. Light weight steel handles. Household use.

UTILITY BASKET

Sku No. Model	Capacity	Dimensions	
		Dia.	Height
622449 32S	1 Bu.	18"	12"

Rubbermaid®

Smoking Urn

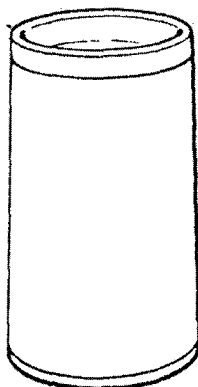

2585

SKU NO. 890115

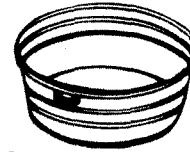

GALVANIZED TUBS

Hot dipped galvanized construction — reinforced wire rim — riveted drop handles - 30 gauge.

WASH TUBS

Sku No. Model	Size	Dimensions		
		Top	Bottom	Height
282210 1 RD	10 ¹ / ₂ Gal.	20"	16 ³ / ₄ "	10 ¹ / ₂ "

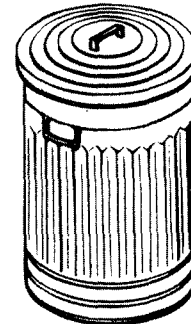

GALVANIZED GARBAGE CANS

GALVANIZED SHEET CANS

Corrugated and swedged sides for strength. Wire reinforced rim. Shipped with covers.

Sku No.	Capacity	Dimensions		
		Top	Bottom	Height
375816 1211	20 Gal. garbage and trash can drop handles.	17"	15 ¹ / ₄ "	23"
375485 1270	31 Gal. garbage and trash can drop handles.	20"	17 ⁷ / ₈ "	27"

WASTE BASKET

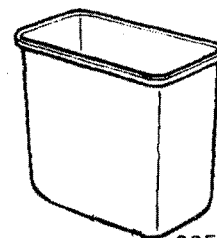

2956

SKU NO.
751106
751108

COLOR
Beige
Brown

Rubbermaid®

**Roughneck®
 Refuse Container
 20 Gallon**

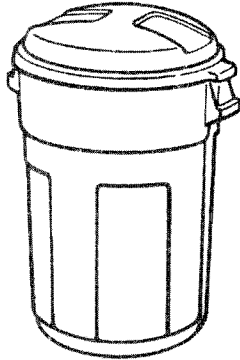

SKU NO. MFG NO.
 751077 2892

**Roughneck®
 Refuse Container
 32 Gallon**

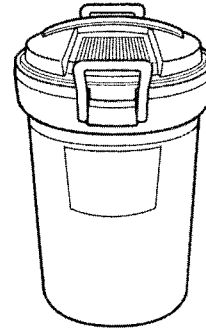

SKU NO. MFG NO.
 751113 1339

**Roughneck® Wheeled
 Refuse Container
 45 Gallon**

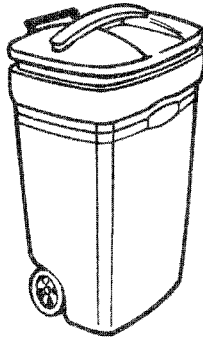

SKU NO. MFG NO.
 751109 1345

**Roughneck®
 Refuse Container
 32 Gallon**

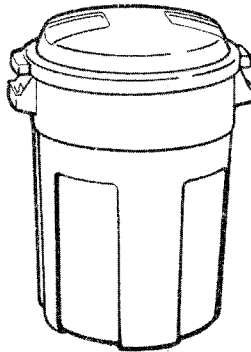

SKU NO. MFG NO.
 751180 2894

**Roughneck®
 Refuse Container
 30 Gallon**

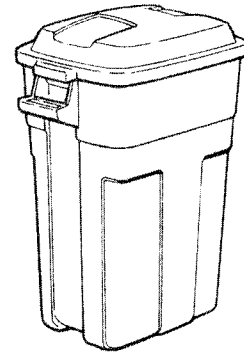

SKU NO. MFG NO.
 751120 2979

**Roughneck®
 Refuse Container
 35 Gallon**

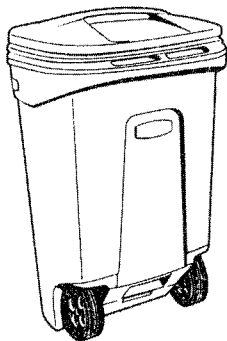

SKU NO. MFG NO.
 751123 1346

**Hooded Wastebasket
 50 Qt.**

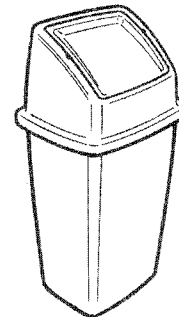

SKU NO.	MFG NO.	COLOR
752120	2804	ALMOND
751123	2804	DARK HUNTER GREEN
751126	2804	SLATE