

ROUND CHIMNEY BRUSHES

SQUARE CHIMNEY BRUSHES

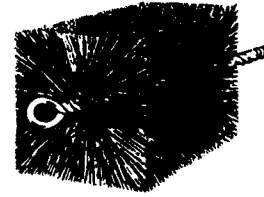
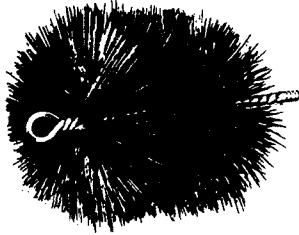

PLASTIC CHIMNEY BRUSHES

Synthetic fibre – 1/4" threaded pipe nipple attached, ring end.

SKU	NO.	BRUSH DIA.	BRUSH LENGTH
650045	36156	5"	6"
650048	36166	6"	6"
650051	36186	8"	6"
650054	36206	10"	6"
650057	36226	12"	6"

SQUARE PLASTIC CHIMNEY BRUSHES

Synthetic fibre – 1/4" threaded pipe nipple attached, ring end.

SKU	NO.	BRUSH SIZE
650060	36258	8" X 8" X 6"
650063	36260	10" X 10" X 6"
650066	36270	12" X 12" X 6"

Use in cold chimneys and pipes for soot removal only.

Use in cold chimneys and pipes for soot removal only.

GALVANIZED FLUE BRUSH HANDLE

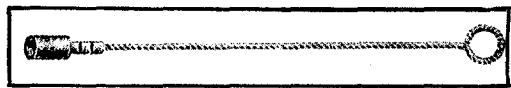

3FEET
 SKU No.
 650102 30328



ROUND FLUE BRUSHES SINGLE SPIRAL

Round black tempered wire – threaded nipples – brush part 4 1/2" long.

SKU	NO.	FLUE SIZE	BRUSH DIA.
650078	43206	1"	3/4"
650081	43208	1 1/4"	1"
650084	43212	1 1/2"	1 1/4"
650087	43216	2"	1 3/4"
650090	43222	2 1/2"	2 1/4"
650093	43226	3"	2 3/4"
650096	43232	3 1/2"	3 1/4"
650099	43236	4"	3 3/4"

Note: Can be furnished in larger diameters.

MECHANICAL CHIMNEY CLEANER

Our mechanical cleaners expand as they're through your chimney, removing the soot that has accumulated in the flue. Three shapes available to clean most common chimneys.

SKU 650069
MODEL NO. 37017
 Fits All Round Chimneys
 6", 7", 8", 9", 10", 11"
 And All Sizes In Between

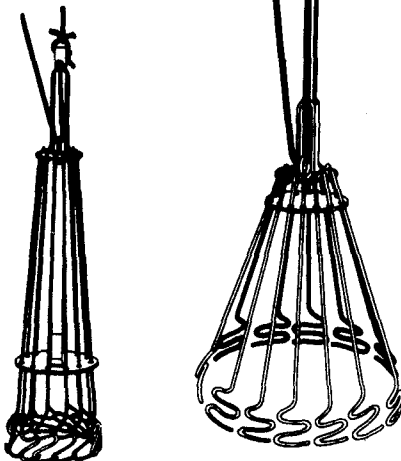

SKU 650072
MODEL NO. 37027
 Fits All Square Chimneys
 6", 7", 8", 9", 10", 11"
 And All Sizes In Between

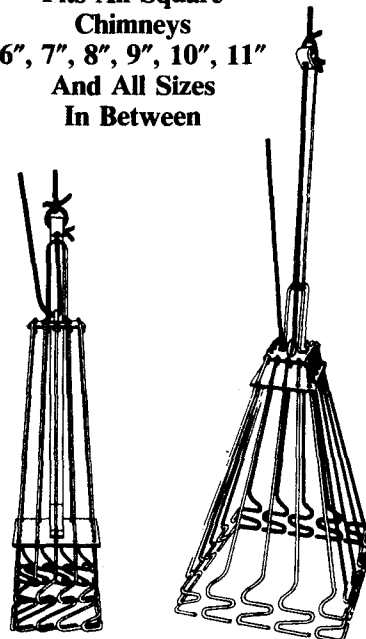

SKU 650075
MODEL NO. 37037
 Fits All Rectangular Chimneys
 6" x 10", 7" x 11",
 8" x 12", 9" x 13",
 10" x 14"
 And All Sizes In Between

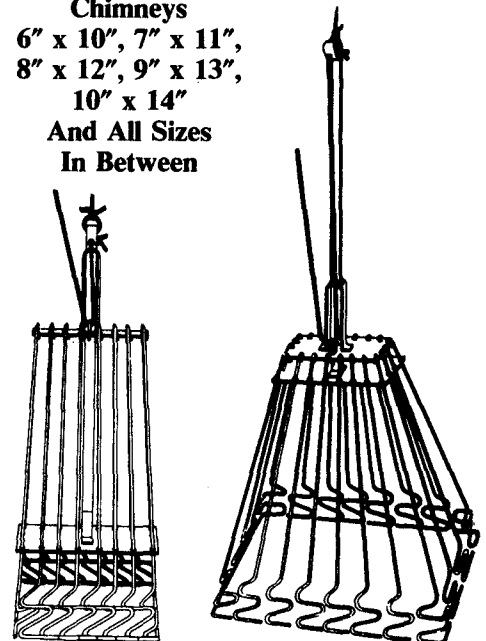

**Grant Wilson
ASBESTOS-FREE**

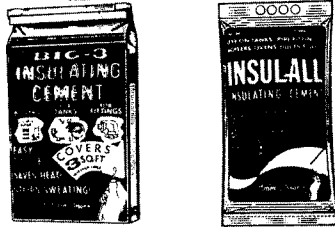

**BIG-3
CEMENT** **1525-10**

These non-toxic insulating cements are a dry compound of high temperature fibrous material and incombustible bonding agents. Mix with water to a thick paste or plaster-like consistency and apply to any clean metal surface. Allow to air-set or dry by low heat.

Big-3 handy pak covers 3 sq. ft. (1/2" thick). Ideal for small patch work, and insulating fittings, joints, etc. for temps. up to 1800°F. Easy to use. Stops sweating. Saves heat.

SKU	MFG#
650150	1533

Insul-All (10 lb. bag) covers up to 15 sq. ft. 1/2" thick for temps. up to 1800°F.

SKU	MFG#
650147	1525-10

**Grant Wilson
SPIRAL-ON INSULATING TAPE**



Thermal Insulating Tape with a closed-cell smooth surfaced, pressure sensitive long-life. Comes in 30 ft. rolls, is 1/8" thick & 2" wide, has a 2" diameter hard paper core. Excellent for preventing sweating and temperature loss-or-gain on cold or hot water lines.

SKU	MFG#	SIZE
650186	2150	2" x 30'



**Grant Wilson
FIREPLACE MORTAR & STOVE CEMENT**

Traditional formula high-temperature mortar for smooth facing, caulking, coating etc., for fireplaces and woodburning stoves. Fireproof, smokeless, non-toxic, odorless, and will not crack, shrink or spall.

SKU NO.	Mfg No.
301440	04343



**Grant Wilson
FYREX PAPER
HANDY ROLL**

18 in. width x 60 ft.
(10 rolls per ctn.)

Economical home and shop size roll of strong, white fireproof Paper. It's vermin proof and acid resistant for all household and garage repair and maintenance needs. Temperature limit 350°F.

SKU	MFG#	SIZE
650153	2250	10" x 60'
650165	2123	18" x 110'

**Grant Wilson
ASBESTOS-FREE
FURNACE & RETORT CEMENT**

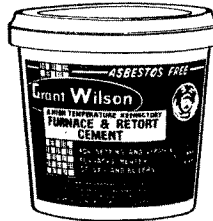

A high grade compound of Long Mineral Fibers, silicates refractory grains and high temperature bonding material. Air-sets to rock hard body. Has high affinity for all metals, making a joint that is air-tight, gas-tight and fireproof for temperatures up to 3000°F. Also used as firebrick mortar and to patch fire boxes. "Packaged to Sell" in colorful lithographed plastic pails.

SKU	MFG#	SIZE
650174	1352	1/2 PT
650180	1354	1 QT
650183	1345	2 QT

FIREPLACE SHOVEL

SKU NO	MFG NO
266932	3

**CHIMNEY BRUSH FIBERGLASS ROD
45" LONG**

SKU NO	MFG NO
650101	30612

**DURO-SHIELD
ALUMINUM / MULTI-FIT**

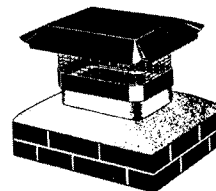

SKU NO.	MFG. NO.	OUTSIDE TILE SIZE (IN INCHES)	FITS OUTSIDE TILE DIMENSION (IN INCHES)
651500	MF303	9 x 9	7 x 7 to 9 1/2 x 9 1/2
651503	MF304	13 x 13	11 1/2 x 11 1/2 to 13 1/2 x 13 1/2
651506	MF305	18 x 18	17 1/2 x 17 1/2 to 18 1/2 x 18 1/2

**Grant Wilson
HIGH TEMPERATURE
PIPE-JOINT TAPE**



This strong paper tape is machine trimmed to exact widths and is used for sealing joints and seams of furnace pipe, and ducts, cabinets, etc., wherever you want to prevent air escape or intake. Also for neat appearance. Temperature limit 350°F.

SKU	MFG#	SIZE
650162	2121	2" x 180'
650165	2123	3" x 180'
650168	2124	3" x 50'

**Grant Wilson
NON-ASBESTOS
MILLBOARD**

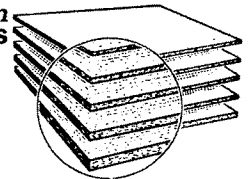

Structurally strong rigid board, made of long mineral fibers and mineral binders formed under pressure, so as to be level, smooth and fireproof. For interior use only. Ideal for protecting areas from fire, gas, and acid fumes. Can be nailed, punched, die cut. Make gaskets, shields, table tops, linings, etc. Sheet size 42" x 48" is correct for 12", 16" and 24" center framing.

Standard thicknesses:

SKU	MFG#	SIZE
650171	1026-3/16	42" x 48"

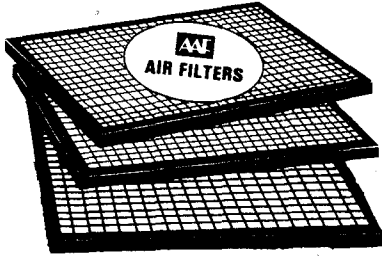

AAF American Air Filter
 Better Air is Our Business®

**DISPOSABLE
 PANEL FILTERS**

**More Adhesive — Higher
 Dust Holding Capacity
 Woven Scrim Retainers —
 Stronger Construction
 Stronger Frame Bond**

- 100% polyester fibers
- 1/2", 1" and 2" thicknesses, blue tint on the air leaving side.
- Available in pre-cut pads and rolls
- Tackified adhesive on the air leaving side

**"CUT - TO - SIZE" FILTERS FOR
 ROOM AIR CONDITIONERS**



15" x 24"

STANDARD SIZES 1" THICK

SKU NO.	MFG. NO.	SIZES
8161	223-035-051	1" x 8" x 16"
8301	223-041-051	1" x 8" x 30"
10101	223-100-051	1" x 10" x 10"
10201	220-200-051	1" x 10" x 20"
10241	220-208-051	1" x 10" x 24"
10251	220-210-051	1" x 10" x 25"
10301	220-214-051	1" x 10" x 30"
12201	220-314-051	1" x 12" x 20"
12241	220-319-051	1" x 12" x 24"
12251	220-321-051	1" x 12" x 25"
12301	220-324-051	1" x 12" x 30 ⁵ / ₈ "
14201	220-371-051	1" x 14" x 20"
14251	220-375-051	1" x 14" x 25"
14301	220-410-051	1" x 14" x 30"
15201	220-400-051	1" x 15" x 20"
15251	220-406-051	1" x 15" x 25"
15301	220-415-051	1" x 15" x 30 ⁵ / ₈ "
16161	220-448-051	1" x 16" x 16"
16201	220-500-051	1" x 16" x 20"
16221	220-515-051	1" x 16" x 22 ¹ / ₄ "
16251	220-600-051	1" x 16" x 25"
18201	220-627-051	1" x 18" x 20"
18241	220-635-051	1" x 18" x 24"
18251	220-631-051	1" x 18" x 25"
19271	220-665-051	1" x 19" x 27"
20201	220-700-051	1" x 20" x 20"
20221	220-715-051	1" x 20" x 22 ¹ / ₄ "
20241	220-782-051	1" x 20" x 24"
20251	220-800-051	1" x 20" x 25"
20301	220-716-051	1" x 20" x 30"
22221	220-839-051	1" x 22" x 22"
24241	220-863-051	1" x 24" x 24"
25251	220-870-051	1" x 25" x 25"
2" THICK		
10102	197-100-052	2" x 10" x 10"
10202	198-200-052	2" x 10" x 20"
14202	217-371-052	2" x 14" x 20"
15202	198-400-052	2" x 15" x 20"
16202	198-500-052	2" x 16" x 20"
16252	220-600-052	2" x 16" x 25"
20202	220-700-052	2" x 20" x 20"
20252	198-800-052	2" x 20" x 25"
24242	198-863-052	2" x 24" x 24"
25252	198-870-052	2" x 25" x 25"

650195 8410 Polyfoam Washable Filters

APRILAIRE HUMIFIER PAD

SKU NO.	MFG. NO.
651208	110
651211	112

**BLUE
 TINT
 MATERIAL
 ROLL**

One-half and one inch thick
FRONTLINE Blue Type S medias are made from single denier polyester fibers bonded together with a fire retardant resin. Two inch thick media is made from dual denier polyester fibers for higher arrestance and dust holding capacity. The fibers are formed into a high loft mat to provide maximum filtration effectiveness with minimum resistance.

A general purpose air filter media for those applications where a synthetic media is preferred. **FRONTLINE** Blue Type S is not recommended for extra heavy dust loading conditions or for installation in systems operating above 500 FPM face velocity.

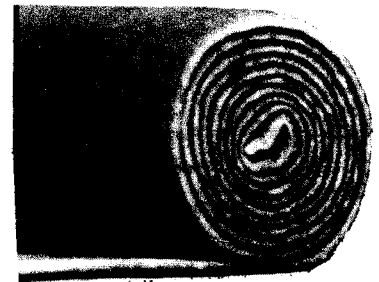

SKU NO.	MFG. NO.	SIZES
242401	150-850-112	24" x 240" x 1"
302401	150-888-112	30" x 240" x 1"
362401	150-908-112	36" x 240" x 1"

FIBREGLASS PADS

650342	250-550-700	20" x 20"
--------	-------------	-----------

Operating Temperature Limits

Fiberglass Medias	
FRONTLINE Gold	175°F (79°C)
FRONTLINE Blue Type FG	175°F (79°C)
FRONTLINE Blue Type FG - Dry	200°F (93°C)
FRONTLINE Green Type FG	175°F (79°C)
FRONTLINE Red	250°F (121°C)
Synthetic Medias	
FRONTLINE Blue Type S	175°F (79°C)
FRONTLINE Green Type S - Dry	175°F (79°C)

Underwriters' Laboratories, Inc. Classification
 All **FRONTLINE** medias are classified U.L. Class 2, except **FRONTLINE Red** which is classified U.L. Class 1.

deflect-o®

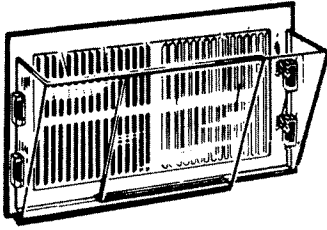

for wall registers

Model 51—Adjusts from 10-inches to 16-inches. Used on wall registers for cooling or heating. Model shown in cooling position, can be reversed for heating. Now with 4 powerful magnets.

SKU
650411 51

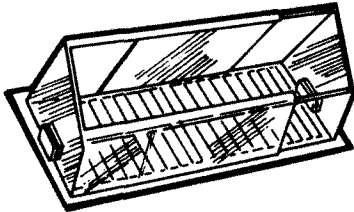

for floor registers

Model 40—Adjusts from 10-inches to 14-inches. Necessary for all floor registers where air conditioning is used. Recommended for more effective cooling.

SKU
650414 40

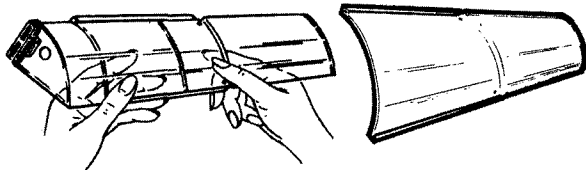

Model 67—Extension Sleeve — Adds up to 12-inches to length of Deflector Models 52, 99 & 53. Can be used in multiples.

SKU
650408 67

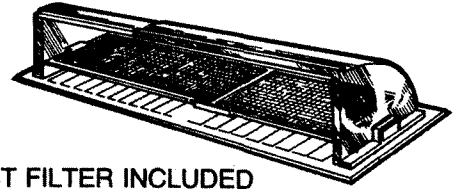

DUST FILTER INCLUDED

Model 52—Adjusts from 10-inches to 14-inches. With replaceable dust filter included in each unit. Used for heating and cooling.

SKU
650402 52

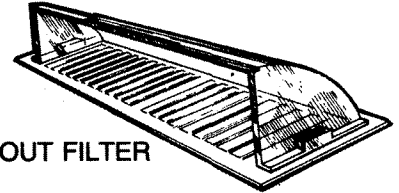

WITHOUT FILTER

Model 99—Adjusts from 10-inches to 14-inches. Does not have a filter. For floor and sidewall registers. Used for heating and cooling.

SKU
650001 99

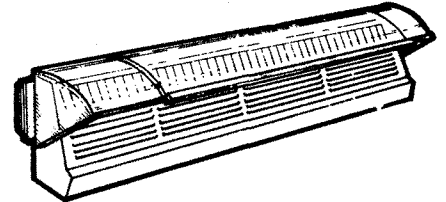

Model 53—Adjusts from 15-inches to 25-inches. For baseboard registers. Used for heating and cooling.

SKU
650405 53

CLOTHES CHUTE DOORS

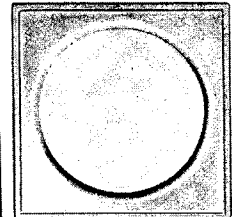
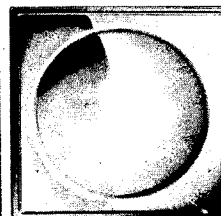

Chrome Plated Finish • White Baked Enamel

Hinged door swings inward as clothes are pushed into chute. Suitable for rubbish and incinerator chutes. Made of heavy-gauge steel, door is spring-loaded. Wide flange covers edge of opening. Specify finish: white enamel or chrome plated.

SKU NO.	MFG No.	Opening Size, Inches
802500	3210	10 x 10
802501	3212	11½ x 11½"

Standard Fire-Rated Access Door

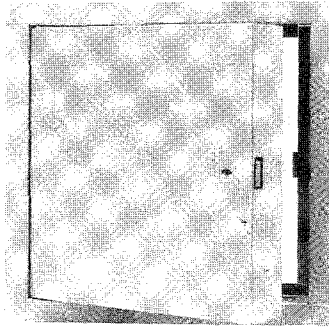

Construction Features:

Door: 18 ga. steel.
Trim and Return Frame: 16 ga. steel.
Insulation: 1-7/8" thick mineral wool contained within door cavity.
Hinge: fully concealed, pivot type hinge. Allows opening to 170°.
Latches: Self-latching direct action lock, opposite hinge. The lock will accept both key and knurled knob which will be included with each door

SKU No.	Door Size	Wall Opening
611878	12" X 12"	12 1/4" X 12 1/4"
611803	18" X 18"	18 1/4" X 18 1/4"
611800	24" X 24"	24 1/4" X 24 1/4"

Access Door for Drywall Surfaces

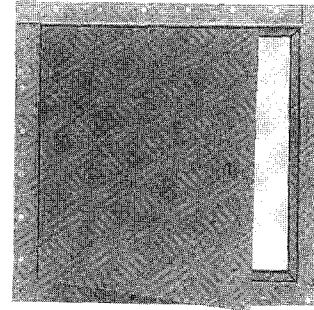

Construction Features:

Door: 14 ga. steel.
Box Return Frame: 16 ga. steel. these models have a 1" wide perforated flange of 24 ga. galvanized material for mounting purposes.
Hinge: fully concealed piano type hinge. Number of hinges varies with size of door unless otherwise requested
Latches: Flush. Stainless steel cam operated with screwdriver. Latches are positioned opposite hinge as well as top and bottom on larger sizes.

SKU No.	Door Size	Wall Opening
611872	12" X 12"	12 1/4" X 12 1/4"
611878	18" X 18"	18 1/4" X 18 1/4"
611876	24" X 24"	24 1/4" X 24 1/4"

Premium General Purpose Access Door

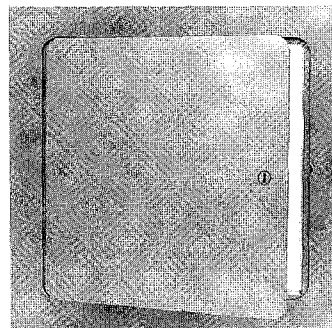

Construction Features:

Door & Trim: 14 ga. steel. trim being 1-1/2" wide.
Return Frame: 18 ga. steel having a depth of 1-3/4".
Hinge: fully concealed piano type hinge. Allows opening to 170°. Number of hinges varies with size of door and will be placed on long side of door unless otherwise requested.
Latches: Flush. Stainless steel cam operated with screwdriver. Latches are positioned opposite hinge as well as top and bottom on larger sizes.

SKU No.	Door Size	Wall Opening
611850	8" X 8"	8 1/4" X 8 1/4"
611853	8" X 12"	8 1/4" X 12 1/4"
611856	12" X 12"	12 1/4" X 12 1/4"
611859	12" X 18"	12 1/4" X 18 1/4"
611862	16" X 24"	16 1/4" X 24 1/4"
611865	18" X 18"	18 1/4" X 18 1/4"
611868	24" X 24"	24 1/4" X 24 1/4"

Lakewood

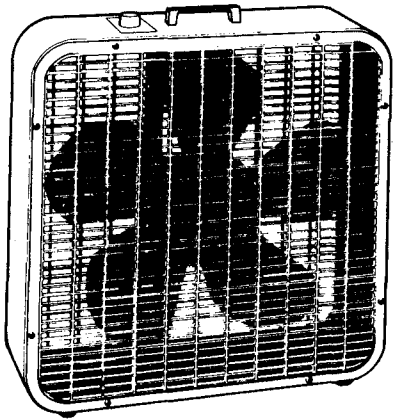

3-SPEED

- Color (P-223)—Almond with White
- Switch—Rotary Dial: High, Medium or Low Speed
- Versatility—

SKU #	MODEL	SIZE
650663	P-223	20"

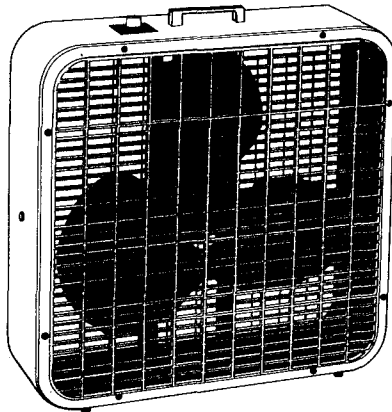

3-SPEED

- Color—Almond with White
- Blade—Aluminum
- Switch—Rotary Dial: High, Medium or Low Speed • Versatility—

SKU #	MODEL	SIZE
650664	P-23	20"

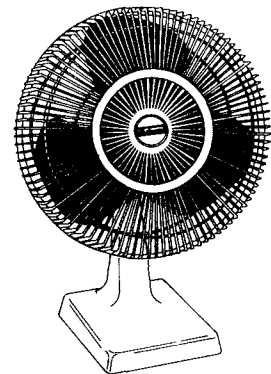

3-SPEED

- Color—Ivory with Slate Grey
- Switch—Slide Type: High or Low Speed
- Safety Grilles—Plastic – Will Not Rust

SKU #	MODEL	SIZE
650678	1200-DX	12"

3-SPEED

SKU #	MODEL	SIZE
650682	1600-DX	16"

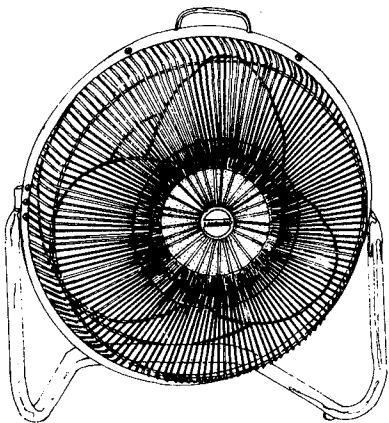

3-SPEED

- Color—Ivory with Slate Grey & Chrome
- Blade—Plastic
- Switch—Rotary Dial: High, Medium or Low Speed
- Stand—Chrome Plated – Adjustable: 360° Circle
- Guards—Chrome Plated
- Cord—3-Wire, 9-Foot Useable – O.S.H.A. Approved

SKU #	MODEL	SIZE
650675	P-1289	12"

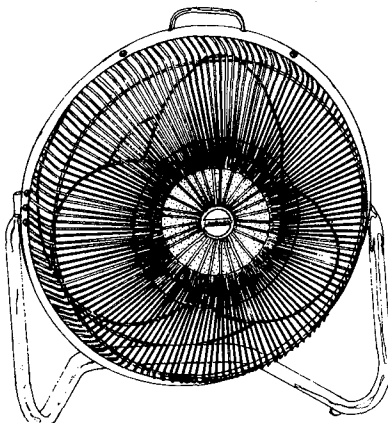

3-SPEED

- Color—Ivory with Slate Grey & Chrome
- Blade—Plastic

NOTE: ALL SPECIFICATIONS IDENTICAL TO No. HV-1289

SKU #	MODEL	SIZE
650672	HV-1889	18"

8

WHERE TO GET IT?
If you can't find it
in our catalog check us
out at our website at:
addisononline.com
or e-mail us at:
abmsls@aol.com



BATH FANS AND COMBINATION UNITS

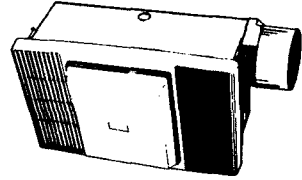

Model 655 Heater/Fan/Light
 • 70 CFM, 3.5 Sones
 • Use with Broan Model 66 Heater/Fan/Light Control (available separately)
 • 20 amp circuit required
 • Suitable for use in insulated ceilings
SKU
 650654

Model 657 Fan/Light
 • 70 CFM, 3.5 Sones
 • Does not include heater
 • Type IC
 • Use with Model 68 Dual Toggle Control (available separately)
SKU
 650705

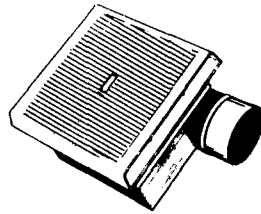

Model 676 Ceiling Fan
 • 110 CFM, 4.0 Sones
 • For bathrooms up to 105 sq. ft.
 • Adjustable mounting brackets span up to 24"
SKU
 650714

Model 678 Fan/Light
 • 50 CFM, 2.5 Sones
 • For bathrooms up to 45 sq. ft.
 • Type IC
 • Polymeric impeller
SKU
 650717

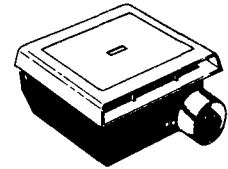
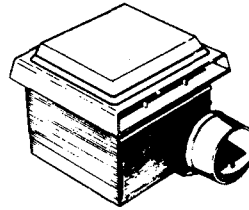

Model 671 Ceiling/Wall Fan*
 • 70 CFM, 3.0 Sones
 • For bathrooms up to 65 sq. ft.
SKU
 650708

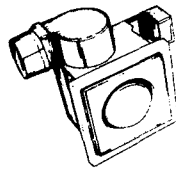
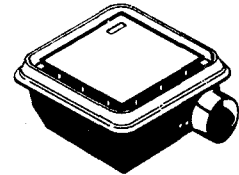

Model 161 One-Bulb Heater
 • 70 CFM, 3.5 Sones
 • Grille 10 $\frac{1}{2}$ " x 10 $\frac{1}{2}$ "
 • One infrared bulb (not included)
 • UL listed for 60° C wiring, without ventilating fan
SKU
 650657

Model 688 Ceiling/Wall Fan*
 • 50 CFM, 2.0 Sones
 • For bathrooms up to 45 sq. ft.
SKU
 650720

UTILITY VENTILATORS

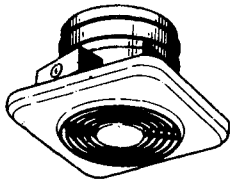

Model 504 10" Vertical Discharge Fan
 • 350 CFM, 6.5 Sones
 • Installs easily between ceiling joists
 • Housing features built-in backdraft damper
 • Fits 10" round duct—uses reducer damper Model 472 for 8" round duct
SKU
 650687

Model 505 8" Vertical Discharge Fan
 • 180 CFM, 5.0 Sones
 • All other features same as Model 504 with an 8 $\frac{1}{4}$ " diameter housing
 • Fits 8" round duct
SKU
 650696

Model 502 10" Side Discharge Fan
 • 270 CFM, 7.0 Sones
 • Installs easily between ceiling joists or wall studs
 • Built-in damper prevents backdrafts
 • Fits 3 $\frac{1}{4}$ " x 10" duct
SKU
 650690



Model 503 8" Side Discharge Fan
 • 160 CFM, 5.0 Sones
 • All other features same as Model 502
SKU
 650693

Model 506 10" Chain-Operated Wall Fan
 • 480 CFM, 6.5 Sones
 • Specially designed polymeric fan blade
 • Pull chain opens door, turns on fan—no wall switch to wire
 • Housing adjusts to fit walls from 4 $\frac{1}{2}$ " to 9 $\frac{1}{2}$ " thick
SKU
 650699

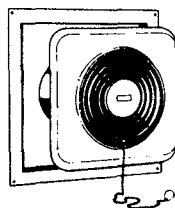

Model 507 8" Chain-Operated Wall Fan
 • 250 CFM, 4.5 Sones • All other features same as Model 506 with an 8 $\frac{3}{8}$ " diameter sleeve
SKU
 650702

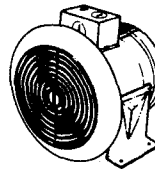

Model 673 Vertical Discharge Ceiling Fan
 • 60 CFM, 4.0 Sones
 • For bathrooms up to 55 sq. ft.
 • Durable, polymeric fan blade
 • Spin-on, white-white polymeric grille
 • Galvanized steel housing
 • Double strength steel mounting brackets with keyhole slots for fast, sturdy installation
SKU
 650711

HOOD AND FAN ACCESSORIES

Model 634 Roof Cap
 • For 3 $\frac{1}{4}$ " x 10" or up to 8" round duct
 • Built-in backdraft damper and bird screen
 • Baked black enamel finish
SKU
 650105

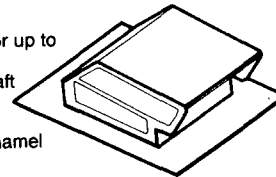

Model 430 Short Eave Elbow
 • For 3 $\frac{1}{4}$ " x 10" duct
 • Includes backdraft damper and grille
SKU
 650106

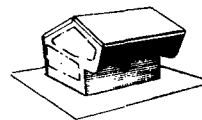

Model 636 Roof Cap
 • For 3" or 4" round duct
 • Built-in damper and bird screen
 • Baked black enamel finish
SKU
 650108

Model 641 Wall Cap
 • For 6" round duct
 • Built-in backdraft damper and bird screen
 • Aluminum
SKU
 650107



No. 472 REDUCER-DAMPER
 Use with No. 471 fan. Reduces from 10" to 8" round. Damper included.
SKU
 650103

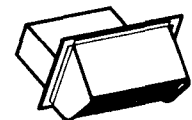

Model 639 Wall Cap
 • For 3 $\frac{1}{4}$ " x 10" duct
 • Spring-loaded backdraft damper
 • Baked enamel finish
SKU
 650104

HEAT STREAM

ARVINAIR

Setting the standards in instant heat.

Heat Stream fan-forced instant heaters have a reputation for their safety, durability and dependability. Year after year, these uprights consistently out perform the competition.

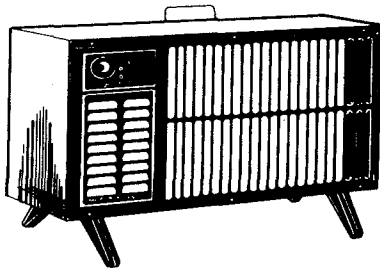

ECONOMY PORTABLE – FAN FORCED INSTANT HEATER

Model 30H25-01
1 heat – 1320 watts (4505 BTUs) • Sturdy steel construction • Energy-saving automatic room thermostat with positive "off" • Automatic safety overheat protection • Safety tip-over switch • Fan-forced instant heat for immediate comfort • Power light • Safety overheat indicator light • Convenient carrying handle • Feet for added stability • Light grey case • 120 volt/60 cycle AC • Has earned U.L. Mark of Safety • 11-1/4"H x 18-1/4"W x 6-3/8"D • 6.3 Lbs • Made in the U.S.A.

SKU NO. 650636

Heat Stream Alert

The original heater with its own safety alarm.

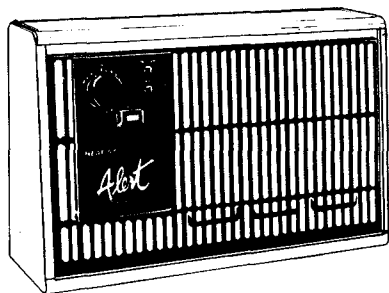

Model 30H50 – Patent #4,755,653
2 heats – 1250/1500 watts (4266/5120 BTUs) • Audible safety alarm • Alert light • Sturdy steel construction • Energy-saving automatic room thermostat • Automatic safety overheat protection • Safety tip-over switch • Fan-forced instant heat for immediate comfort • Heat selector on/off switch • Power light • Convenient carrying handle • Dark grey case • 120 volt/60 cycle AC • Has earned U.L. Mark of Safety • 11-3/4"H x 18-3/8"W x 5-1/4"D • 8.0 Lbs. • Made in the U.S.A.

SKU NO. 650642

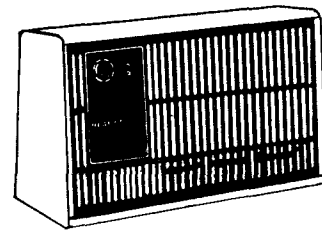

TWO HEAT – FAN-FORCED INSTANT HEATER

Model 30H21
2 heats – 1250/1500 watts (4266/5120 BTUs) • Sturdy steel construction • Energy-saving automatic room thermostat with positive "off" • Automatic safety overheat protection • Safety tip-over switch • Fan-forced instant heat for immediate comfort • Heat selector switch • Power light • Safety overheat indicator light • Convenient carrying handle • Light grey case • 120 volt/60 cycle AC • Has earned U.L. Mark of Safety • 11-3/4"H x 18-3/8"W x 5-1/4"D • 7.7 Lbs. • Made in the U.S.A.

SKU NO. 650633

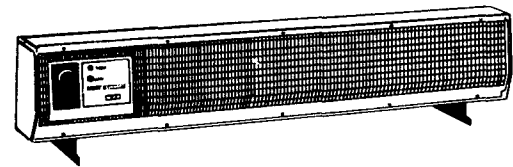

40 INCH TWO HEAT PERIMETER HEATER

Model 49H20-1
2 heats – 1250/1500 watts (4266/5120 BTUs) • Sturdy steel construction • Energy-saving automatic room thermostat with positive "off" • Automatic safety overheat protection • Safety tip-over switch • Fan-forced instant heat for immediate comfort • Heat selector switch • Power light • Safety overheat indicator light • Convenient carrying handle • Feet for added stability • Light grey case • 120 volt/60 cycle AC • Has earned U.L. Mark of Safety • 9"H x 40"W x 4-1/8"D • 11.1 Lbs. • Made in the U.S.A.

SKU NO. 650624

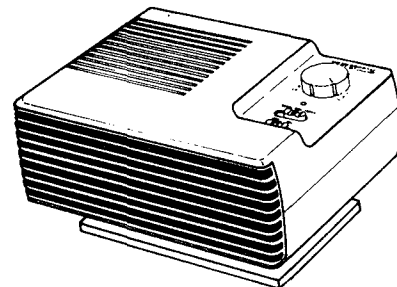

TWO HEAT – LOW PROFILE HEATER/FAN

Model 29H40
2 heats – 800/1500 watts (2731/5120 BTUs) • Powerful fan-forced whole room heat • Fan only setting for cooling • Two separate slide switches for on/off and heat/cool settings • Adjustable tilt base • Energy-saving automatic room thermostat • Automatic safety overheat protection • Power light • White and Black • 120 volt/60 cycle AC • Has earned U.L. Mark of Safety • 5-3/16"H x 10"W x 8"D • 3.5 Lbs.

SKU NO. 650630

MasterPlumber
 Gas Water Heaters

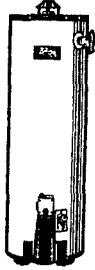

helps you save energy too!
 Heavy-gauge steel construction with foam insulation.

SKU NO.	CAPACITY	DESCRIPTION
811844	40 Gallon	Model 5-40-NKRT 5 year tank warranty, 2 year parts warranty 35,500 BTU's 36 gallons per hour 3" draft hood .58 energy factor 1" foam insulation R-value 8.33 factory installed T&P valve. unit dimensions 60" tall x 18" diameter
811901	40 Gallon	Model 5-40-nort 5 year tank warranty 1 year parts warranty 32,000 BTU's 33 gallons per hour 3" draft hood .57 energy factor 1" foam insulation R-value 8.33 factory installed T&P valve unit dimensions 60" tall x 18" diameter
811919	50 Gallon	Model 5-50-nort 5 year tank warranty 1 year parts warranty 32,000 BTU's 33 gallons per hour 3" draft hood .54 energy factor 1" foam insulation R-value 8.33 factory installed T&P valve unit dimensions 60" tall x 20" diameter
142486	75 Gallon	Model 5-75-NRRT-J 5 year tank warranty 1 year parts warranty 75,100 BTU's 76 gallons per hour 4" draft hood .57 energy factor 1" foam insulation R-value 8.33 factory installed T&P valve Unit dimensions 64" tall x 24" diameter

FLEXIBLE COPPER WATER CONNECTORS



SKU 611311 Model PS 0012	Water Connector - 12" 3/4" F.I.P. x 3/4" F.I.P. x 12" 1 Per Bag. 15.5"H x 2.5"W x 0.8"D
SKU 611314 Model PS 0018	Water Connector - 18" 3/4" F.I.P. x 3/4" F.I.P. x 18" 1 Per Bag. 18"H x 2.5"W x 1.1"D
SKU 611318 Model PS 0024	Water Connector - 24" 3/4" F.I.P. x 3/4" F.I.P. x 24" 1 Per Bag. 24"H x 2.5"W x 1"D

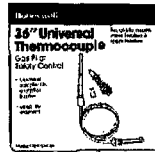

UNIVERSAL THERMOCOUPLE

SKU NO.	MFG. NO.	LENGTH
609280	CQ100A-1021	18"
609285	CQ100A-1013	24"
609290	CQ100A-1039	30"
609295	CQ100A-1005	36"
609300	Q340A-1108	48"

**LOWER THERMOSTAT
 SINGLE ELEMENT**



Single Element Water Heater Lower Thermostat With High Limit Reset. For 240V Water Heaters, Clam Shell.
 SKU Mfg. No.
 304220 304220

**UPPER THERMOSTAT
 DOUBLE ELEMENT**



Adjustable Water Heater Upper Thermostat With High Limit Reset. For Use With 240V Double Element Water Heaters, Clam Shell.
 SKU Mfg. No.
 304238 304238

**LOWER THERMOSTAT
 DOUBLE ELEMENT**



Double Element Water Heater Lower Thermostat, For 240V Water Heaters, Clam Shell.
 SKU Mfg. No.
 304279 304279

**SOCKET WRENCH
 FOR HEAT ELEMENTS**



Water Heater Element Wrench, Heavy Duty, 1-1/2" x 5" Socket With Handle And Extension, For Replacing Screw In Water Heater Elements Which Have 3" Offset From Jacket To Element, Clam Shell.
 SKU Mfg. No.
 605849 808444

**ELEMENT WITH
 GASKET 4-BOLT**

1440W 120V Electric Water Heater Universal Flange Element With High Watt Density, Contains 1 - "UP" Element And 1 - "TG" Gasket, 8" Minimum Tank Diameter, A Direct Replacement Or Can Replace Either Round Head Or Flat Head Flange Elements Using Supplied Gaskets, Fits Most Makes & Models Other Than Those Using Screw In Flange Type Elements, Clam Shell.

SKU Mfg. No.
 605504 808576



**SCREW IN ELEMENTS
 120V - 1440 WATTS/2000 WATTS**



1440W 120V Electric Water Heater Screw In Flange Element With High Watt Density, Contains 1 - "TR" Screw In Element And 1 - "TR" Gasket, Minimum Tank Diameter: 8", Use With Model #9000030 (ITEM #808774) Element Adapter Kit, Fits Master Plumber, Ace, State, Reliance, Sears, Rheem, Rudd, Montgomery Ward & Most Other Water Heaters, Clam Shell.
 2000W 120V Electric Water Heater Screw In Flange Element With High Watt Density, Contains 1 - "TR" Screw In Element And 1 - "TR" Gasket, 12" Minimum Tank Diameter, Use With Model #9000030 (ITEM #808774) Element Adapter Kit, Fits Master Plumber, Ace, State, Reliance, Sears, Rheem, Rudd, Montgomery Ward, & Most Other Water Heaters, Clam Shell.

SKU Mfg. No.
 808485 808485 1440 watt
 608500 808535 2000 watt

**DIALECTRIC HEAT
 TRAPPER**



Heat Trap, Contains - 1 Cold Water Inlet Heat Trapper And 1 Hot Water Outlet Heat Trapper, Energy Saving Water Heater Connection, Prevents Rising Heat From Escaping Through Connections, Also Serves As A Dielectric Fitting To Prevent Corrosion And Prolong Tank Life.

SKU Mfg. No.
 605486 808709

**SCREW IN ELEMENT
 240V/4500 WATT**

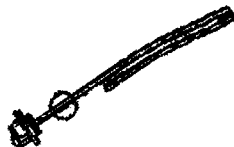

4500W 240V Electric Water Heater Screw In Flange Element With Low Watt Density, Contains 1 - "TR" Element And 1 - "TR" Gasket, 14" Minimum Tank Diameter, Use With Element Adapter Kit (Item #808774), Fits Ace, State, Reliance, Sears, Rheem, Rudd, Montgomery Ward And Most Other Water Heaters, Clam Shell.

SKU Mfg. No.
 808451 808451

**SCREW IN ELEMENT
 240V/4500 WATT**

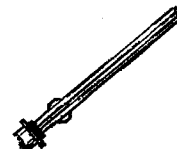

4500W 240V Electric Water Heater Screw In Flange Element With High Watt Density, Contains 1 - "TR" Screw In Element And 1 - "TR" Gasket, 12" Minimum Tank Diameter, Use With Model #9000030 (ITEM #808774) Element Adapter Kit, Fits Master Plumber, Ace, State, Reliance, Sears, Rheem, Rudd, Montgomery Ward & Most Other Water Heaters, Clam Shell.

SKU Mfg. No.
 608394 808394

**ALUMINUM WATER
 HEATER PAN 24"**

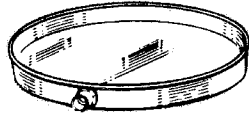

SKU Mfg. Co.
 134312 134312

**NO BURST
 WATER HEATER
 CONNECTORS**

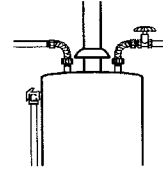

SKU Mfg. Co. Size
 604885 B1H12 12" 3/4" Female Iron Pipe
 604890 B1H18 18" X
 604895 B1H24 24" 3/4" Female Iron Pipe

Counter-Sunk B.P.I. Plugs



SKU No.	Catalog #	Size
605267	3790	1½"
605273	3791	2"
605276	3792	2½"
605279	3793	3"
605282	3794	3½"
605288	3795	4"
605294	3797	5"
605303	3799	6"

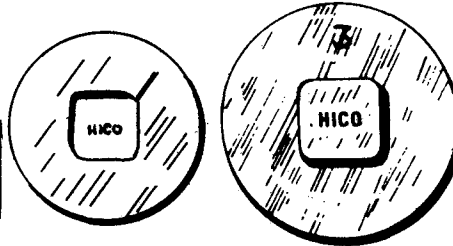

**B.P.I. Cleanout Plug
 Southern Pattern**

SKU No.	Catalog #	Size
605207	3800	1½"
605213	3801	2"
605216	3802	2½"
605219	3803	3"
605222	3804	3½"
605228	3805	4"
605234	3807	5"
605243	3809	6"

CAST IRON SOIL PIPE AND FITTINGS

**5' FOOT
SINGLE HUB SOIL PIPE**

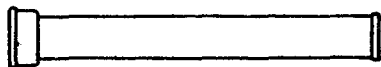

SKU NO.	Mfg. No.	Size
607780	0006	4" x 5'
607925	0010	6" x 5'

5' DOUBLE HUB SOIL PIPE

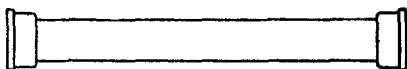

SKU NO.	Mfg. No.	Size
607785	0026	4" x 5'
607930	0030	6" x 5'
607790	0086	4" x 30"

DOUBLE HUB



SKU NO.	Mfg. No.	Size
607830	6502	4"
607960	6504	6"

1/8 BEND



SKU NO.	Mfg. No.	Size
607800	0128	4" x 45°
607940	0130	6" x 45°

1/4 BEND

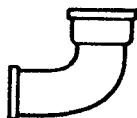

SKU NO.	Mfg. No.	Size
607795	0102	4" x 90°
607935	0104	6" x 90°

LARGE SERVICE

607805	0251	4" x 90°
--------	------	----------

OFFSET COLLARS



SKU NO.	Size
607880	4" x 2" x 2"

CLOSET BENDS

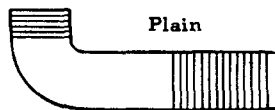

SKU NO.	Size
607825	4" x 12'

SANITARY TEE

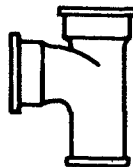

SKU NO.	Mfg. No.	Size
607810	0555	4"
607945	0564	6"

TAPPED SANITARY TEE



SKU NO.	Mfg. No.	Size
607900	2615	4" x 2"

CLOSET COLLARS

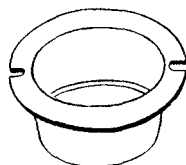

SKU NO.	Mfg. No.	Size
607845	2655-1	4" x 1"
607850	2655-3	4" x 2"
607855	2655-4	4" x 2 1/2"
607860	2655-5	4" x 3"
607865	2655-6	4" x 4"
607870	2655-8	4" x 6"

GASKETS

SKU NO.	Size	Type
607836	4"	TY-Seal
607970	6"	TY-Seal

P TRAP



SKU NO.	Mfg. No.	Size
607965	7024	6"
607835	2665	4"

Y BRANCH

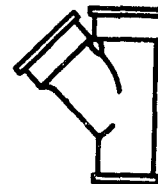

SKU NO.	Mfg. No.	Size
607815	0605	4"
607950	0614	6"

SADDLE TEE

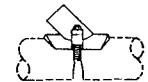

Y Saddle Hub



Tee Saddle Hub

TEE SADDLE HUB

SKU NO.	Mfg. No.	Size
607895	6685	4" x 4"
607905	6737	4" x 1.5"

**IRON FERRULE
WITH BRASS PLUG**

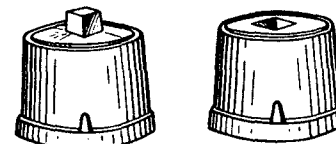

SKU NO.	Mfg. No.	Size
607840	2640	4"
607955	2642	6"

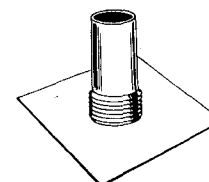

LEAD FLASHING

SKU NO.	SIZE
605018	4"
605021	6"
605564	5"

CLAY SEWER PIPE



Size	Plain	O-Ring
4" x 2'	200000	200405
4" x 4'	200005	200410
6" x 2'	200010	200415
6" x 4'	200020	200420
8" x 2'	200025	—



ELBOWS 90°

Size	Plain	Type	O-Ring
4"	200110	Short	200490
6"	200215	Short	200525
6"	200220	Med.	—
6"	—	Long	200530



CURVES

Size	Plain	Type	O-Ring
4"	200125	Short	200492
4"	200135	Long	—
6"	200230	Short 45°	200520
6"	200235	Med. 45°	—
8"	200335	Short 45°	—
6"	—	Short 30°	—
8"	—	Med. 45°	—

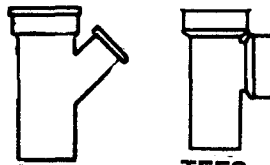

WYE

TEES

Size	Plain	Type	O-Ring
4"	200175	TEE	200485
4"	200180	WYE	—
6"	200265	TEE	200500
6" x 4"	200270	TEE	200510
6"	200275	WYE	200495
6" x 4"	200280	WYE	200505
6"	200285	Double TEE	—
8"	200340	TEE	200550
8" x 4"	200347	TEE	—
8" x 6"	200348	WYE	200555



SADDLE TEE

Size	Plain	Type	O-Ring
6"	200310	—	—
6"	200315	Slant	—



TRAPS

Size	Plain	Type	O-Ring
4"	200155	P	—
4"	200165	Running	—
6"	200260	P	—
6"	200261	CB	—



DOUBLE HUBS

Size	Plain	O-Ring
6"	200300	—

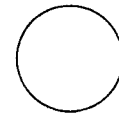

STOPPER

Size	Plain	O-Ring
4"	200200	200481
6"	200305	200531
8"	200346	200551

SEWER PIPE LUBRICANT

SKU NO.	Mfg. No.	Size
201634	C425	Qt.
201635	C425	Gallon

WALL COPING

Size	SKU NO.	Description
13"	200395	Coping Double Slant-PL-4FTPC
9"	200400	Coping Double Slant-PL-4FTPC

To provide weather cover for 8" or 12" block walls

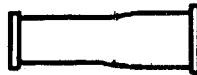

REDUCER

Size	Plain	Type
6" x 4"	200320	(6" Bell)
8" x 6"	200355	(8" Bell)

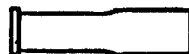

INCREASER

Size	Plain	Type	O-Ring
4" x 6"	200325	(4" Bell)	200540
6" x 8"	200360	(6" Bell)	200537

CORNERS

Size	SKU NO.	Description
13"	200401	Double Unit
9"	200396	Double Unit

A.S.T.M.D. 3034

This specification covers the requirements and test methods for materials, dimensions, workmanship, flattening resistance, impact resistance, pipe stiffness, extrusion quality, joining systems, and a form of marking for sewer pipe fittings.

PVC-PSM SEWER PIPE

**GASKET JOINT
 PSM SEWER PIPE
 SDR-35
 ASTM
 D-3034**

SKU NO.	SIZE	O.D.	MIN. WALL	LENGTH	PART NUMBER
201604	4"	4.215	.120	13'	53725
201636	6"	6.275	.180	13'	53785
201691	8"	8.400	.240	13'	53805

**GASKET JOINT
 PSM SEWER PIPE
 SDR-26
 ASTM D-3034**

201602	4"	4.215	.162	13'	53505
201638	6"	6.275	.241	13'	53525

PVC SDR 35 FITTINGS

90° EII

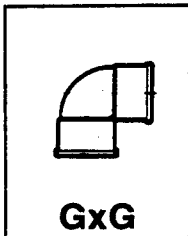

SKU NO.	SIZE
201622	4"
201644	6"
201704	8"

GxG

90° EII

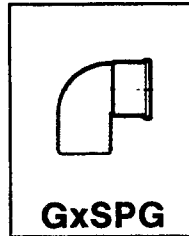

SKU NO.	SIZE
201641	6"

GxSPG

Cleanout Adapter

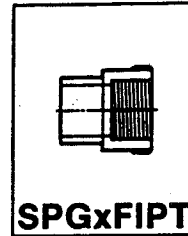

SKU NO.	SIZE
201612	4"
201668	6"

SPGxFIPT

45° EII

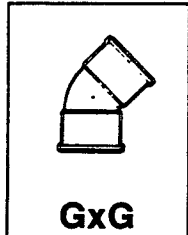

SKU NO.	SIZE
201631	4"
201651	6"
201701	8"

GxG

45° EII

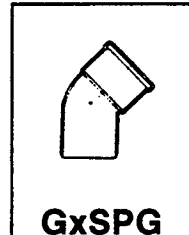

SKU NO.	SIZE
201647	6"

GxSPG

Cleanout Adapter

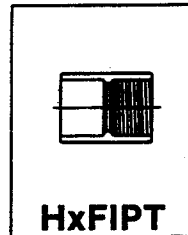

SKU NO.	SIZE
201613	4"
201666	6"

HxFIPT

22½° EII

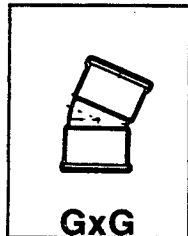

SKU NO.	SIZE
201628	4"
201657	6"
201697	8"

GxG

22½° EII

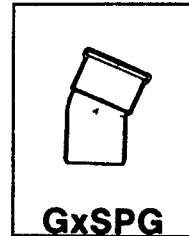

SKU NO.	SIZE
201654	6"

GxSPG

Tee

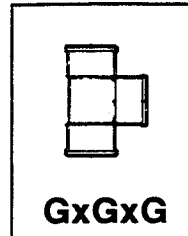

SKU NO.	SIZE
201624	4"
201664	6"
201710	8x8x6
201694	8"

GxGxG

Coupling

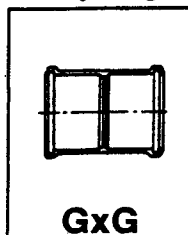

SKU NO.	SIZE
201661	4"
201707	6"
201707	8"

GxG

Male Thread Plug

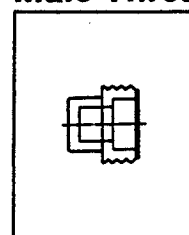

SKU NO.	SIZE
201614	4"
201672	6"

Tee Sanitary

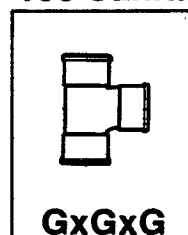

SKU NO.	SIZE
201627	4"
201658	6"

GxGxG

8

PVC-PMS SEWER PIPE

Tee Sanitary

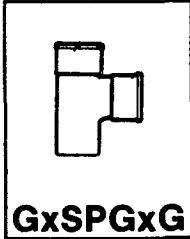

SKU NO.	SIZE
201626	4"
201667	6"

GxSPGxG

Wye

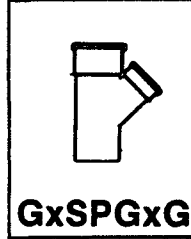

SKU NO.	SIZE
201616	4"

GxSPGxG

Increaser

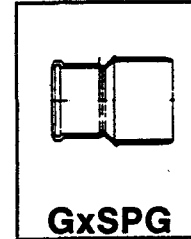

SKU NO.	SIZE
201687	4x6
201716	6x8

GxSPG

Tee

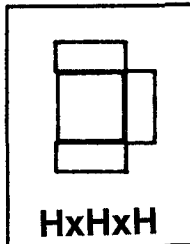

SKU NO.	SIZE
201652	6"

HxHxH

Wye

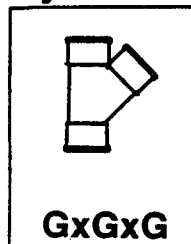

SKU NO.	SIZE
201671	6"
201713	8"

GxGxG

SDR35 Solvent Weld Coupling

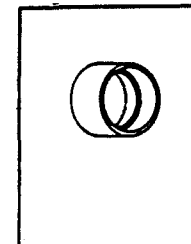

SKU NO.	SIZE
201610	4"
201662	6"

SDR35 Tee

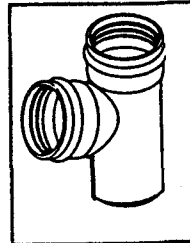

SKU NO.	SIZE
201619	4"
201659	6"

GSKT/GSKT/SPGT

45 Wye

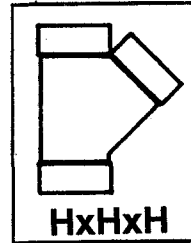

SKU NO.	SIZE
201669	6"

HxHxH

SDR35 Saddle Tee-GSKT

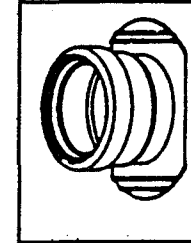

SKU NO.	MFG. NO.	SIZE
201632	07-06-45-0604	4" x 6"
201684	07-08-45-0806	8" x 6"

CAN'T FIND IT?
Visit our website at:
addisononline.com
or e-mail us at:
abmsls@aol.com

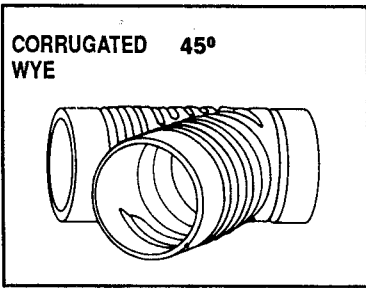

CORRUGATED 45° WYE

SKU NO.	MFG. NO.	SIZE
201595	FC-YOB-01	4"
201435	FC-YOB-06	6"

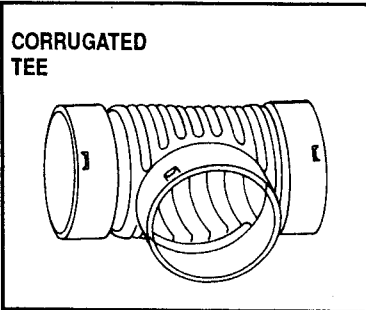

CORRUGATED TEE

SKU NO.	MFG. NO.	SIZE
201570	FC-TOB-04	4"
201415	FC-TOB-06	6"
201425	BLIND TEE FC-TBB-06	6"

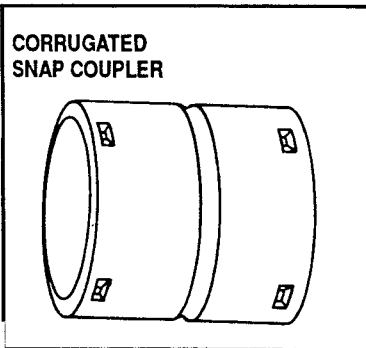

CORRUGATED SNAP COUPLER

SKU NO.	MFG. NO.	SIZE
201575	FC-CLB-04	4"
201420	FC-CLB-06	6"

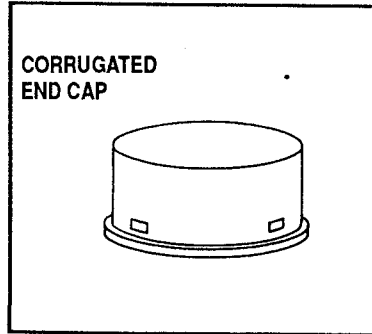

CORRUGATED END CAP

SKU NO.	MFG. NO.	SIZE
201593	FC-EOB-04	4"
201433	FC-EOB-06	6"
201585	PERFRID END PLUG FC-EQB-04	4"

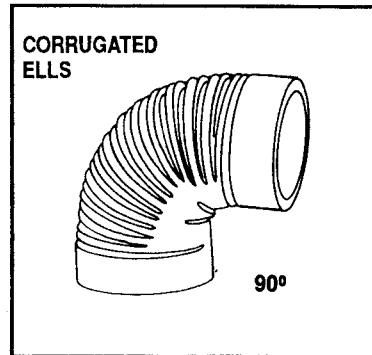

CORRUGATED ELLS 90°

SKU NO.	MFG. NO.	SIZE
201590	FC-LOB-04	4"

PERFORATED CORRUGATED PIPE

SKU NO.	MFG. NO.	SIZE
600116	5001	2"
201565	HD-PFI-04	4" x 10'
201560	HD-PFI-04	4" x 100'
201405	HD-PFI-06	6" x 100'

SOLID CORRUGATED PIPE

SKU NO.	MFG. NO.	SIZE
600114	5000	2"
201555	HD-PLI-04	4" x 10'
201550	HD-PLI-04	4" x 100'
201395	HD-PLI-06	6" x 100'

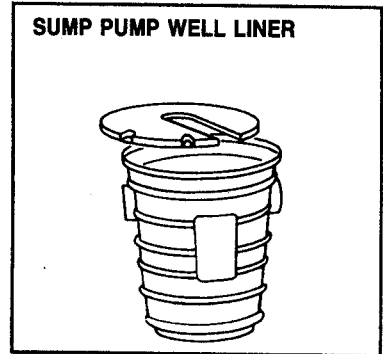

SUMP PUMP WELL LINER

SKU NO.	MFG. NO.	SIZE
201445	CA-SW4-18	30"
201440	CA-SW4-18	24"

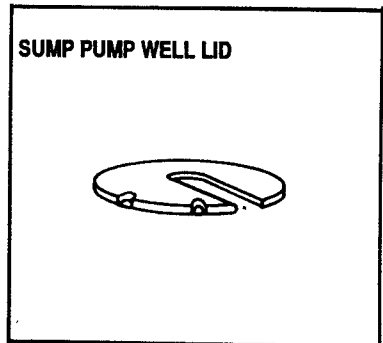

SUMP PUMP WELL LID

SKU NO.	MFG. NO.	SIZE
201455	CA-LWN-18	18"

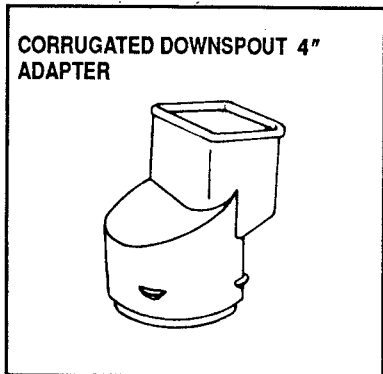

CORRUGATED DOWNSPOUT 4" ADAPTER

SKU NO.	MFG. NO.	SIZE
201600	FC-D5B-04	2" x 3"
201605	FC-D7B-04	3" x 4"

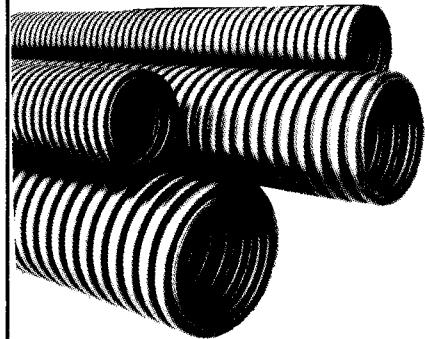

Available In Perforated or Solid Corrugated



SEWER AND DRAIN

WHITE HIGH IMPACT VIRGIN STYRENE

Description	SKU NO.	Mfg. No.	Size
Drain Grate SP	201530	3273	4"



Down Spout Adapter DS x H	201540	3195	4"
---------------------------------	--------	------	----



Cap Hub	201535 201536	3184 3185	4" 6"
------------	------------------	--------------	----------

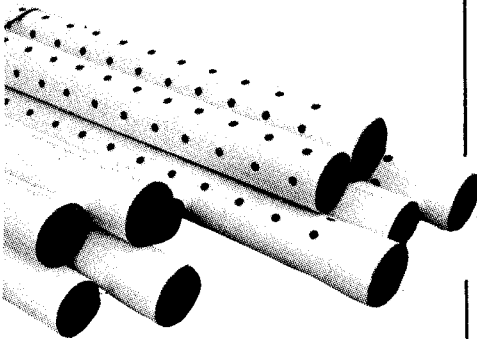

SMOOTH WALL DRAIN PIPE

SKU NO.	MFG. NO.	SIZE	TYPE
201460	DW-3EH-04	4" x 10'	Solid
201470	DW-3EH-06	6" x 10'	Solid
201465	DW-DEH-04	4" x 10'	Perf
201475	DW-OEH-06	6" x 10'	Perf

Description	SKU NO.	Mfg. No.	Size
90° Ell	201485	3166	4"
(1/4 Bend) H x H	201490	3212	6"

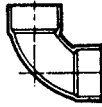

45° Ell (1/4 Bend) H x H	201495	3163	4"
--------------------------------	--------	------	----



SMOOTHWALL END CAP

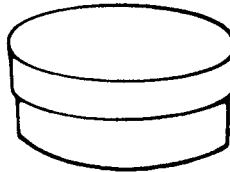

SKU NO.	MFG. NO.	SIZE
201592	FC-PZO-04	4"

Description	SKU NO.	Mfg. No.	Size
45° WYE All Hub	201505 201510	3199 3214	4" 6"

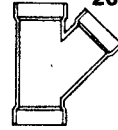

Sanitary Tee All Hub	201480	3173	4"
-------------------------	--------	------	----

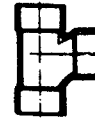

Coupling H x H	201520 201525	3153 3220	4" 6"
-------------------	------------------	--------------	----------

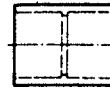

Reducing Coupling H x H	201515	3215	6"
-------------------------------	--------	------	----

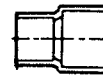

Tee All Hub	201481	3213	6"
----------------	--------	------	----

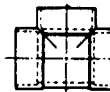

Our catalog does not contain everything in our inventory. If there are products you do not find that are related to those in this catalog call 437-1288 so that we may assist you.

CLAY DRAIN TILE

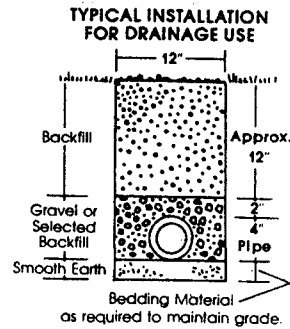
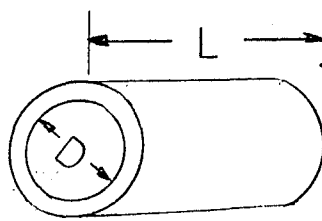

Note: 12" width is suggested to allow easy access for proper bedding. Other widths may be used if good bedding practices can be obtained.

DIA (D)	TILE	ELBOW	TEE	L
4	201325	201350	201360	12"
6	201330	201351	201361	12"
8	201335		201362	12"
10	201340		201363	12"
12	201345		201364	12"

SUMP TILE

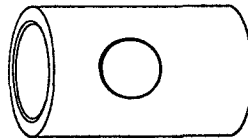

DIA (D)	24" DEEP	30" DEEP	6" EXTENSION
16"	201365	201375	201390
18"	201370	201380	201385

SPEE-D CHANNEL PARTS

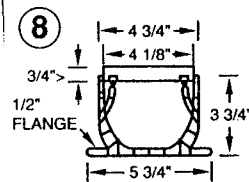

Standard "SPEE-D" Channel
 Ideal for industrial, commercial, and residential applications requiring rugged dependability and excellent chemical resistance. Acceptable for ground level applications.

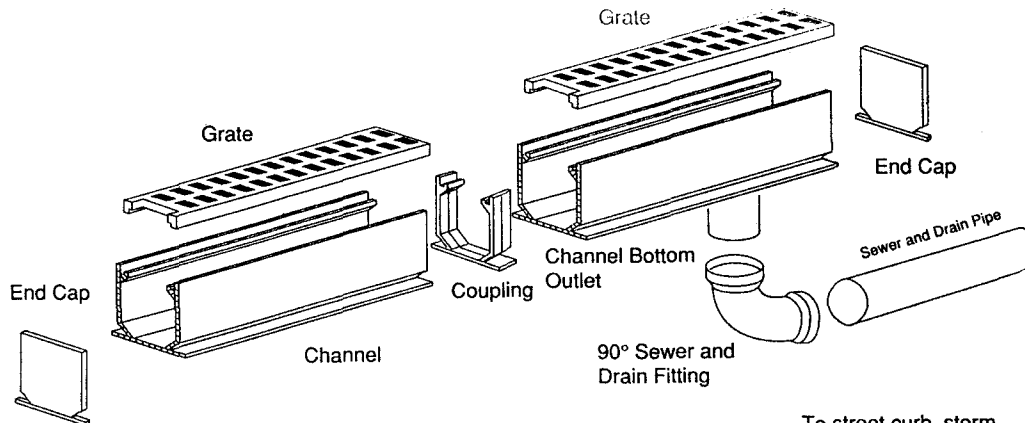

To street curb, storm water sewer or other runoff system.

SKU NO	"MFG #	DESCRIPTION	COLOR
207000	400	4" X 48" CHANNEL DRAIN	GREY
207025	234	4" X 24" CHANNEL DRAIN WITH BOTTOM OUTLET	GREY
207005	241	4" X 24" CHANNEL GRATE	GREY
207010	243	4" X 24" CHANNEL GRATE	BLACK
207015	246	END CAP WITH 2" OUTLET	GREY
207020	249	END CAP WITH 3" OUTLET	GREY
207030	247	END CAP WITHOUT OUTLET	GREY
207035	248	CHANNEL DRAIN COUPLING	GREY

8

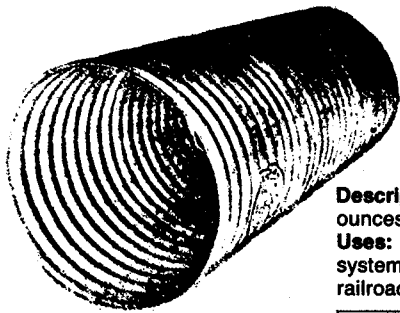

CULVERT

CULVERT METAL CORRUGATED

STANDARD GALVANIZED



Description: The base metal sheets are zinc coated on both sides. A minimum of 2 ounces of zinc per square foot of double exposed surface.

Uses: For culverts, small bridges, storm sewers, conduits, sub-drainage systems, irrigation systems, siphons, levees, farm ponds, and similar installations. Used under highways, railroads, air fields, golf courses, and for industrial applications.

LENGTH	8"	10"	12"	15"	18"	21"	24"
2 FOOT		200650		200750	200800	200850	
4 FOOT		200655			200805		
6 FOOT	200610	200660			200810	200860	
8 FOOT	200615	200665	200715	200765	200815	200865	200905
10 FOOT	200620	200670	200720	200770	200820	200870	200910
12 FOOT	200625	200675	200725	200775	200825	200875	200915
14 FOOT	200630		200730	200780	200830	200880	200920
16 FOOT	200635	200685	200735	200785	200835	200885	200925
18 FOOT		200690	200740		200840		200930
20 FOOT	200645	200695	200745	200795	200845	200895	200935
24 FOOT						200900	

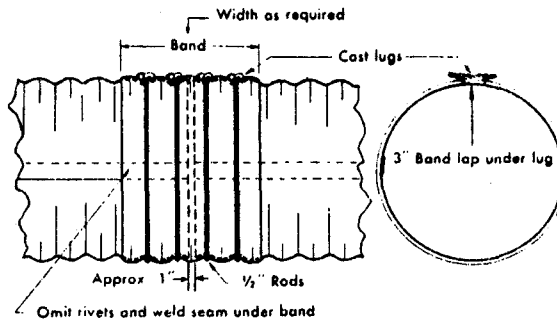

BAND

Two or more sections of corrugated steel pipe are joined together in the field by means of coupling bands that are made of the same material as the pipe. Bands lap equally over adjoining ends of pipe sections, with interlocking corrugations.

	8"	10"	12"	15"	18"	21"	24"
1 FOOT	200980	200990	201000	201010	201020	201030	201040
2 FOOT	200985	200995	201005	201015	201025	201035	201045

END SECTION

LENGTH	12"	15"	18"	24"
END SECTION	200940	200943	200945	200951

SPIRAL SOLID

LENGTH	6"	8"
10 FOOT		200590
20 FOOT	200585	200595

SPIRAL BAND

LENGTH	6"	8"
20 FOOT	200970	200975

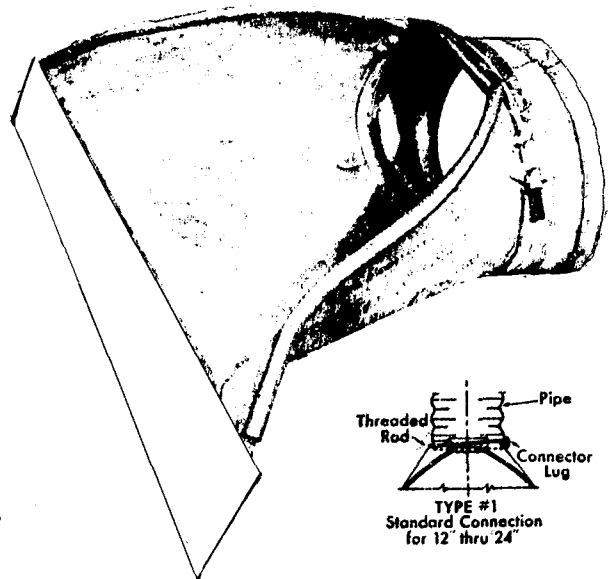
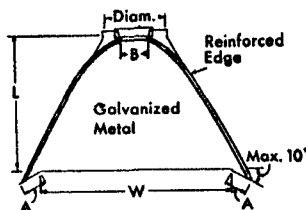

CATCH BASIN RINGS

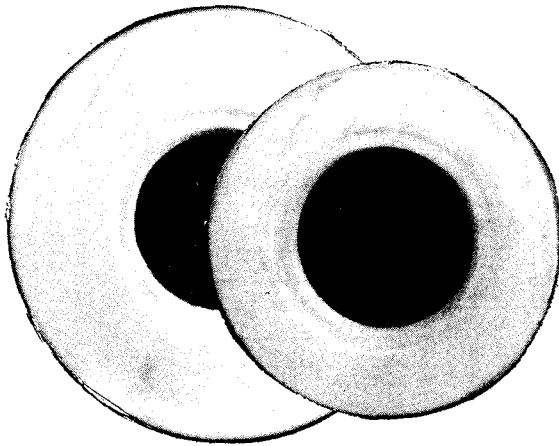

SKU NO.	Size
201265	30" x 18"
201270	36" x 18"

SEWER EXTENSION RINGS

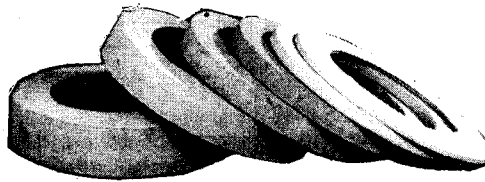

SKU NO.	SIZE	ADJUSTMENT
201275	1" x 24" ID	34" OD
201280	2" x 24" ID	34" OD
201285	3" x 24" ID	34" OD
201290	4" x 24" ID	34" OD
201295	6" x 24" ID	34" OD
201300	8" x 24" ID	34" OD

CATCH BASIN BOTTOM

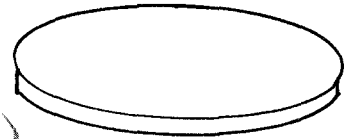

SKU NO.	Size
201240	24"
201250	36"
201260	60"

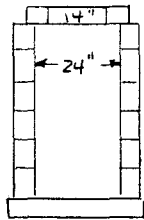
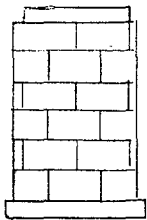

24" CATCH BASIN
7 BLOCKS PER RING

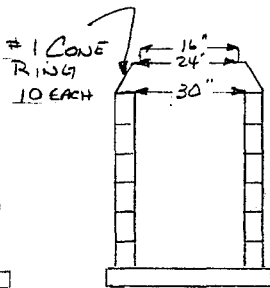
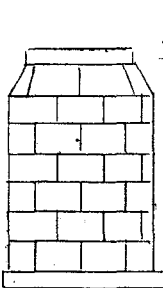
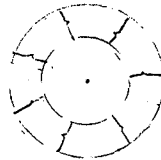

30" CATCH BASIN
7 BLOCKS PER RING

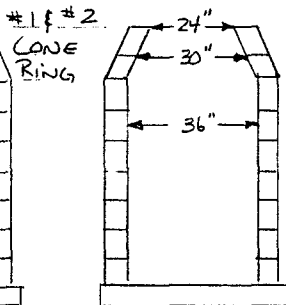
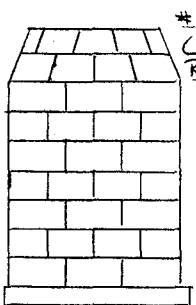
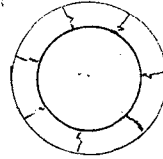

36" CATCH BASIN
8 BLOCKS PER RING

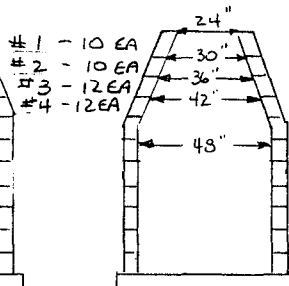
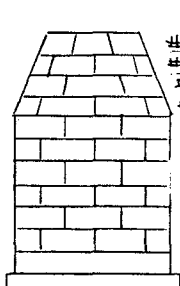
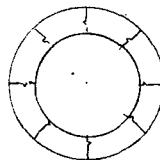

48" CATCH BASIN
10 BLOCKS PER RING

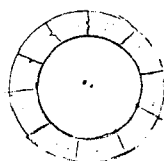

Sewer & Catch Basins are assembled without mortar between joints. A portland base mortar is plastered over the entire interior to form a water-proof cavity after assembly is completed.

CATCH BASINS

SKU NO.	SIZE	COURSE
201195	24"	7
201205	36"	8
201210	48"	10
201215	60"	15

CONE BLOCKS

201220 #1	30"	10
201225 #2	36"	10
201230 #3	42"	12
201235 #4	48"	12

CAST IRON



SKU NO.	Model No.	Description
201310	910	1" Riser
201305	919K	1½" Riser

Cast Iron, Plastic to Steel

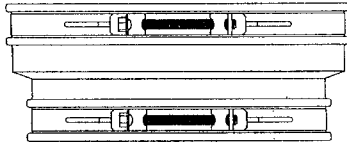

Increaser/Reducer Coupling

SKU NO.	MFG. NO.	SIZE
201650	0406744	6" x 4"
201645	0408864	8" x 6"

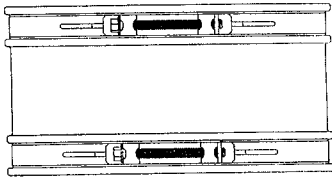

Standard Coupling

SKU NO.	MFG. NO.	SIZE
201675	0404665	4"
201670	0406728	6"

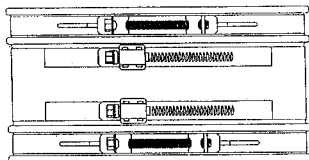

Adjustable Repair Coupling

SKU NO.	MFG. NO.	SIZE
201665	0408807	8"
201660	0410704	10"
201655	0412650	12"

QWIK CAPS

in cap pipe ends, cap for testing, cap for cleanouts.

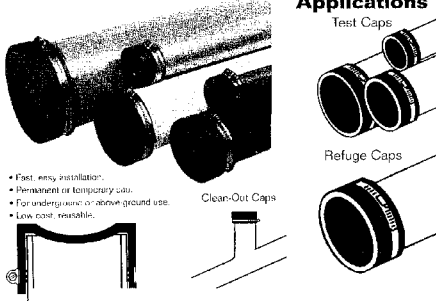

Applications

- Fast, easy installation.
- Permanent or temporary caps.
- For underground or active ground use.
- Low cost, reusable.

SKU NO.	MFG. NO.	PIPE SIZE
523670	QC-101	1-1/2"
523688	QC-102	2"
523696	QC-103	3"
52802	QC-104	4"

FERNCO®
Flexible Couplings

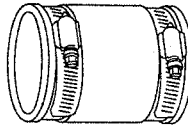

Cast Iron, Plastic, Copper, Steel or Lead to Cast Iron, Plastic, Copper, Steel or Lead

SKU NO.	MFG. NO.	PIPE SIZE
140640	1056-125	1 1/4" x 1 1/4"
221432	1056-22	2" x 2"
341917	1056-33	3" x 3"
252924	1056-44	4" x 4"
606326	1056-64	6" x 4"
606322	1056-66	6" x 6"
606324	1056-88	8" x 8"

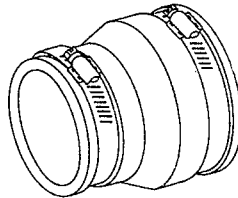

Reducing-Clay to Cast Iron or Plastic

SKU NO.	MFG. NO.	PIPE SIZE
606310	1002-64	6" x 4"

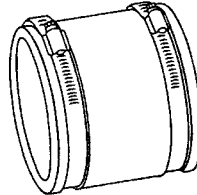

Clay to Cast Iron or Plastic

SKU NO.	MFG. NO.	PIPE SIZE
111203	1002-44	4" x 4"
606315	1002-66	6" x 6"
606317	1002-88	8" x 8"

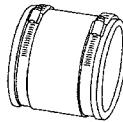

Clay to Clay

SKU NO.	MFG. NO.	PIPE SIZE
606320	1001-66	6" x 6"

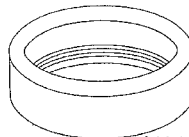

Reducer Bushing

SKU NO.	MFG. NO.	SIZE
201685	0504449	4" Clay to 4" Cast Iron
201690	0504456	4" Clay to 4" Iron Pipe Size
201680	0504514	4" Clay to 4" PVC
201700	0506410	6" Clay to 6" Cast Iron

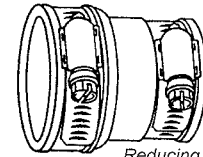

Reducing Coupling

Cast Iron, Plastic, Copper, Steel or Lead to Cast Iron, Plastic, Copper, Steel or Lead

SKU NO.	MFG. NO.	PIPE SIZE
140723	1056-150/125	1 1/2" x 1 1/4"



Shielded Specialty Coupling For Drain, Waste & Vent Systems Connects Cast Iron, Plastic, Steel & Copper

SKU NO.	MFG. NO.	PIPE SIZE
695692	3000-44	4" x 4"



FLEXIBLE QWIK TRAPS

Fits 1-1/2" or 1-1/4" drain pipe. Flexible PVC adjusts to pipe misalignment.

SKU NO.	MFG. NO.	PIPE SIZE
584409	FT-150	1-1/2" or 1-1/4"

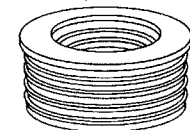

Bushings

SKU NO.	MFG. NO.	SIZE
606300	P44V-139	4" C1 x 1 1/2" PVC
606305	P44V-205	4" C1 x 2" PVC
523639	P44V-305	4" C1 x 3" PVC
523647	P44V-405	4" C1 x 4" PVC

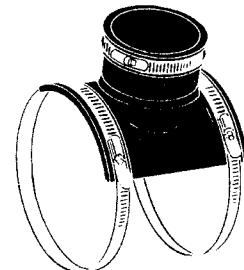

Flexible Saddle Tee W/Clamp

SKU NO.	MFG. NO.	SIZE
631000	DFW-4T/C	4" x 12" x 4"

F e r n c o

QWIK CAPS

to cap pipe ends, cap for testing, cap for cleanouts.

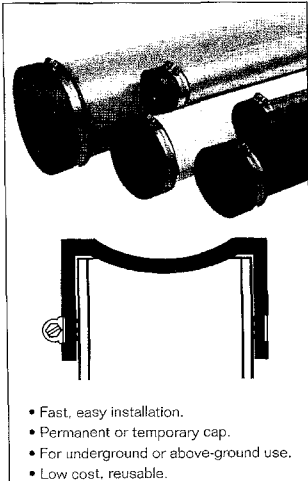

Applications

Test Caps

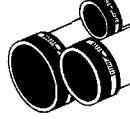

Refuge Caps



Clean-Out Caps

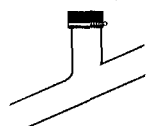

- Fast, easy installation.
- Permanent or temporary cap.
- For underground or above-ground use.
- Low cost, reusable.

SKU NO.	MFG. NO.	SIZE
523670	QC-101	1-1/2"
523688	QC-102	2"
523696	QC-103	3"
528802	QC-104	4"

QWIK TEE

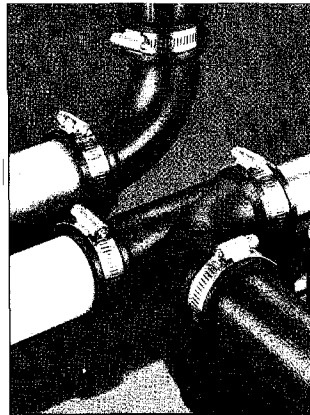

Let you connect all common household drain, waste and vent pipes quickly and easily without using special tools or fittings. Because they're exceptionally flexible and extra long, they're the ideal replacement for fittings cut out at the joint during alteration or repair. The connectors are easily installed by tightening the stainless steel clamps. Made from flexible PVC, Qwik-Tees and Qwik-Elbows come in four sizes (1-1/2", 2", 3" and 4") and fit all common household pipes including cast iron, steel, plastic, copper and lead. Reducing sizes are made with separately supplied bushings.
 Qwik Ellis

SKU	Mfg. No.	Size
528828	QT-200	2"

F e r n c o

SPANNER FLANGES®

for repair of broken water closet flanges.

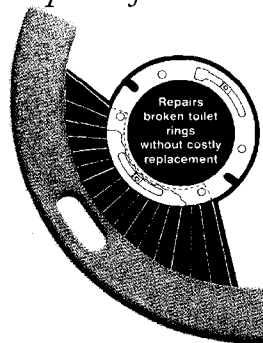

Spanner Flanges

eliminate the need to replace broken closet flanges, saving time and money. Simply place the flange under the broken area of the ring and tighten the nut.

Suitable for use with cast iron, plastic, copper and brass closet flanges.

Part No. SF-100

- Fits all cast iron, plastic, copper & brass water closet flanges.
- Stops wobbly, leaking toilets.
- Installs fast & easy.

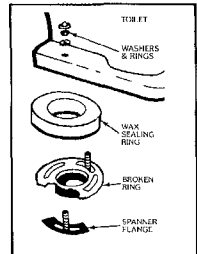

SKU	MFG. No.
523597	SF-100

SHEAR RINGS

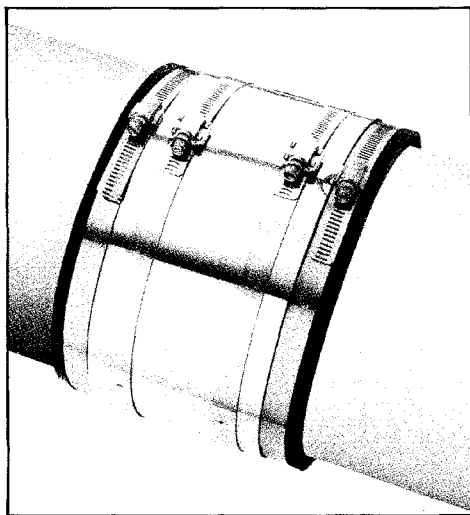

Fernco Coupling Part No.	Use Aux. Shear Ring No.
1001-66	SR-27

Stainless Steel Shear Rings

add extra strength and rigidity to just about any size couplings. They're easy to attach and help maintain proper alignment in even the most unstable ground conditions. Bushings are separately supplied for material transition and size reduction.

- All stainless steel bands, nuts, and housings (Series 300 Stainless Steel).
- Designed to fit Fernco's 1001 (Clay to Clay), 1004 (Concrete to Concrete), 1055 (AC to AC) or 1056 (Cl/Plastic to Cl/Plastic) series couplings.
- Available for 1-1/2" to 15" couplings.

SKU	Mfg. No.	Size
606329	SR-27	6"

**TILE STRAINERS –
 CAST IRON FOR CLAY PIPE**



SKU NO.	Model No.	For Pipe Size	Overall Diameter	Overall Height
201125	4-T	4"	5 5/8"	1 1/2"
201130	6-T	6"	8"	2"
201135	8-T	8"	10 1/4"	2 1/4"
201140	10-T	10"	12 1/4"	2 3/8"
201145	12-T	12"	14 3/4"	2 1/2"
201150	15-T	15"	18 3/8"	2 5/8"
201155	18-T	18"	22"	2 3/4"

Flex Flood-Stopppers

High Impact Plastic
 Prevents Flooding

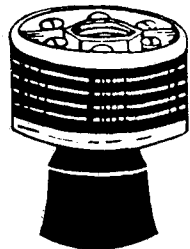
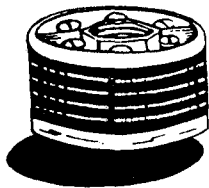

SKU No.	Catalog #	Description
605183	3470	For 4" Pipe (Tapped 1 1/2")
605186	3475	For 4" Pipe Float type

Test Plugs With Metal Parts

Fits Into Soil Pipe

Re Usable

SKU No.	Catalog #	Description
605206	3573	1 1/2"
605201	3574	2"
605204	3575	3"
605093	3576	4"

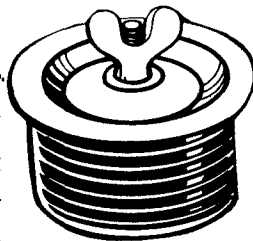

Plastic Bar Grate



SKU No.	Catalog #	Description
605153	3320	5"



**Polished Stainless Steel
 Extension Covers**

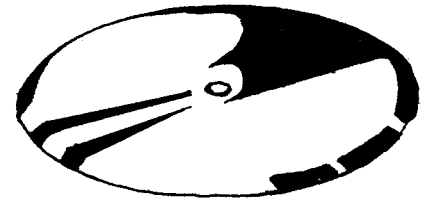

SKU No.	Catalog #	Description
605246	3840	4"
605249	3842	6"
605252	3843	8"
605258	3844	10"
605261	3845	12"
605264	3846	14"

Lead Fit-All Cleanout Plugs

Malleable Iron Core
 Square Head for Wrench

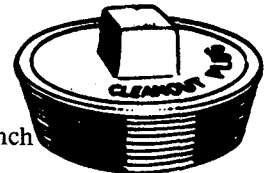

SKU No.	Catalog #	Description
605156	3350	2"
605159	3351	2 1/2"
605162	3352	3"
605165	3353	3 1/2"
605168	3354	4"
605174	3356	5"
605177	3358	6"

Cast Iron Bar Grates

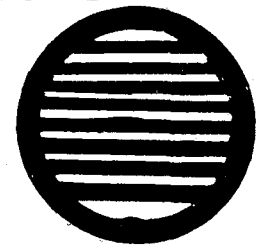

SKU No.	Catalog #	Description
605138	2670-1	2 1/2" Bar Grate
605141	2670-2	3" Bar Grate
605144	2670-3	3 1/2" Bar Grate
605147	2670-4	4" Bar Grate
605150	2670-5	5" Bar Grate
605151	2670-7	7" Bar Grate
201180	9F	8" Bar Grate

TEST PLUG • GALVANIZED STEEL FLANGES



PART NO.	PLUG SIZE	SKU
154-012	5"	SKU 605209
154-013	6"	SKU 605212

- Rubber gaskets
- Large wing nuts for easy operation
- Engineered and designed for maximum gripping power in all types of pipe

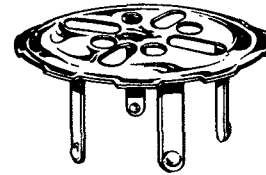

Mfg. No	Description
1265	Floor Drain Cover SKU 611185 3" cover fits 2" drain. Stainless steel.
1266	Floor Drain Cover SKU 611186 4" cover fits 3" drain. Stainless steel.
1267	Floor Drain Cover SKU 611187 5" cover fits 4" drain. Stainless steel.

Drum Trap Covers

Cat. No. Description

1022 **Extension Cover**
 Stainless Steel 5 1/4" Cover with 3" Counter Sunk Plastic Plug and 1/4"-20 x 2 1/4" Brass Screw. **SKU 611162**

1023 **Adjustable Cover**
 Style "A" 5 1/4" Stainless Steel Cover Fits 3 1/4" to 4" Diameter. Self Adjusting Includes Rubber Gasket. **SKU 611163**

1024 **Adjustable Cover**
 Style "B" Same as 1023 Except with Additional Steel Plate and Rubber Gasket. **SKU 611164**

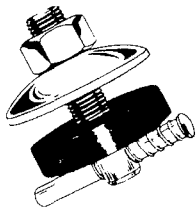

THE TOGGLE BAR BOILER REPAIR PLUG HARDENED STEEL, CADMIUM PLATED

R406900 1 1/2" Plate Regular size plug **SKU 608020**

WING NUT TESTING PLUGS

FIG #	DESCRIPTION
606113	2" SKU 602031
606213	3" SKU 602032
606313	4" SKU 602034
606513	6" SKU 606513

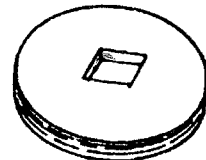

SOLID BRASS CLEANOUT PLUG COUNTERSUNK

SKU	Mfg. No.	SIZE
605267	3790B	1-1/2"
605273	3791B	2"
605276	3792B	2-1/2"
605279	3793B	3"
605288	3795B	4"
605294	3797B	5"
605303	3799B	6"

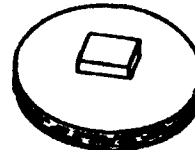

SOLID BRASS CLEANOUT PLUG RAISED HEAD

SKU	Mfg. No.	SIZE
605207	3800B	1-1/2"
605213	3801B	2"
605216	3810	2-1/2"
605219	3811	3"
605222	3812	3-1/2"
605228	3813	4"
605234	3814	5"
605243	3815	6"

R-5900 — R-5901 Series
Frame and Solid Lid or Grate

Heavy Duty — Round for Slab Construction

For Corrugated Metal Pipe sized to fit snugly into opening of corrugated pipe of size indicated.

Additional anchorage to metal pipe may be accomplished by drilling holes in the sleeve or barrel portion of the frame and bolting the frame in place. Frames can be furnished drilled for this purpose on special order.

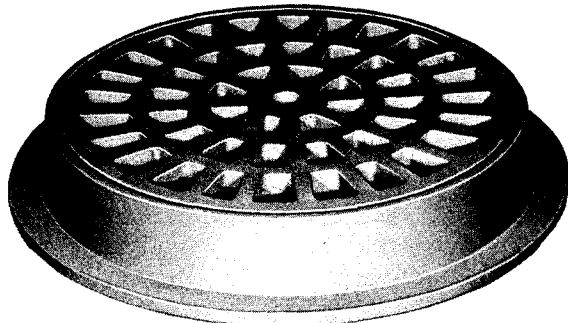

Illustrating R-5900 with type "C" grate

Furnished standard with ground bearing surfaces.

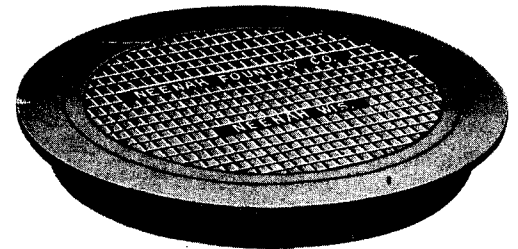

Illustrating R-5900 Frame and Solid Lid

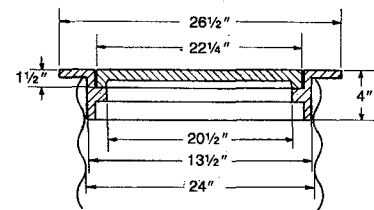

	SKU NO.	PART NO.	WT.
FRAME	201124	5900	65
SOLID LID	201122	TYPE C	80
GRADED LID	201123	2510	95

R-4340B Series
Round Beehive Grates

Medium Duty — For Ditch Drainage Construction

May be used in vitrified clay pipe bell, on a concrete catch basin, or in a cast iron frame as shown below. Effective where debris may interfere with drainage, such as at a road-side or in a median strip.

Bell and spigot vitrified clay and concrete pipe are made under many specifications and dimensions vary. Check the grate sizes in the table to be sure they will fit the pipe you are using.

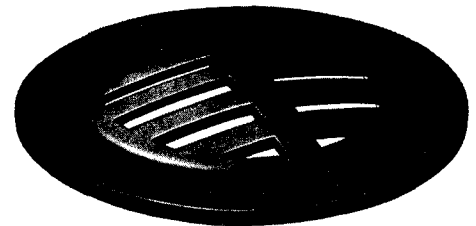

Illustrating R-4340-B

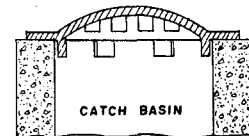

SKU No.	Part No.	Dimensions in inches									Wt. Lbs.
		O. Dia.	O.D. Lugs	Dia. Bhv.	Ht. Bhv.	No. Lugs	Size Bars	Size Op.	Pipe Size		
201120	R-4340-B	33	23	23	3	6	1 1/2	2	24	200	

BELL TRAPS — CAST IRON — LOOSE LID — OUTSIDE CAULK

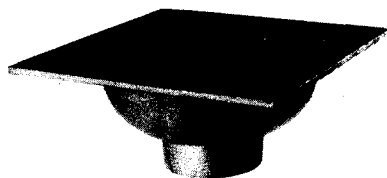

SKU NO.	Model No.	Size	Outlet
201185	66	6" x 6" x 2"	1 5/8"
201190	99	9" x 9" x 3"	2 5/8"

CATCH BASIN LID — CAST IRON

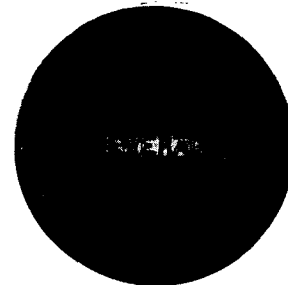

SKU NO.	Model No.	Diameter
201315	18	18"

R-1712 Series Manhole Frames, Solid Lids

Heavy Duty

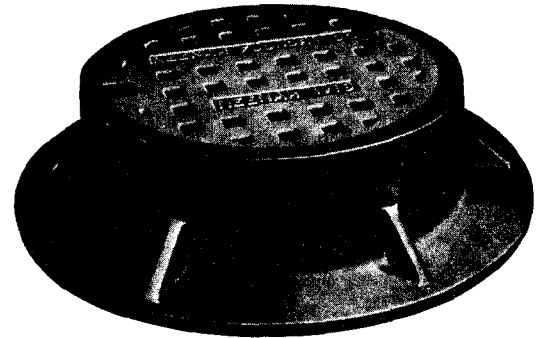
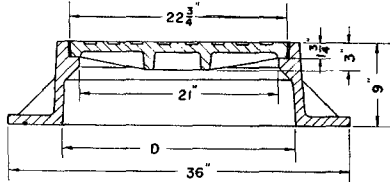

**R-1712 SERIES,
 MANHOLE FRAMES GRATED LID SHOWN**

	SKU NO.	PART NO.	WT. LBS.
FRAME	201085		400
SOLID LID	201100	1015	140
GRATED LID	201095	2015	120

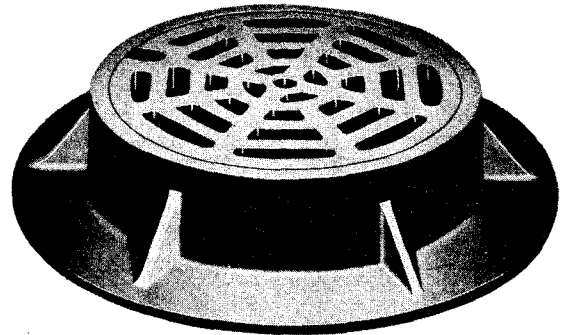

Illustrating R-1712 with Type "D" grate

**R-1772 Series
 Manhole Frames, Solid Lids**

Heavy Duty

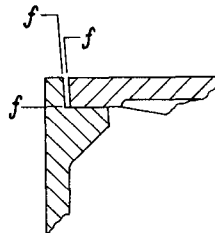
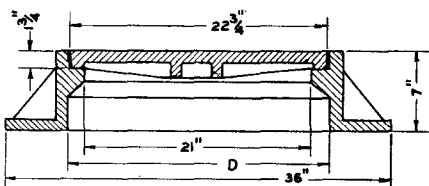

**Machined Horizontal
 Vertical Bearing Surface**

	SKU NO.	PART NO.	WT. LBS.
FRAME	201055	1772	250
SOLID LID	201100	1015	140
GRATED LID	201095	2015	120

