

600-POUND BRASS BALL VALVES

- SKU**
A=608915
B=608920
C=608925
D=608930
E=608935
F=608940
G=608945
H=608950
 (* = Special Order)

FULL PORT, two-piece body, blowout-proof stem, lever handle, screwed and soldered-joint ends.
 AGA/CGA/UL/FM approved (Fig. #5044F 1/2" - 2").
 Conforms to specifications of MSS SP-110.

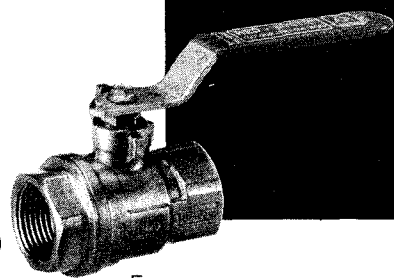

FIGURE #5044F Screwed-Ends		DIMENSIONS Unit: inch										
Mark	Size	1/4	3/8	1/2	3/4	1	1-1/4	1-1/2	2	2-1/2*	3*	4*
		A	B	C	D	E	F	G	H			
L		1.73	1.73	2.13	2.56	2.91	3.39	3.90	4.45	6.02	6.81	7.64
H		1.57	1.57	2.11	2.24	2.56	2.80	3.27	3.58	4.69	5.12	5.61
E		3.27	3.27	3.64	3.64	5.04	5.04	5.63	5.63	11.18	11.18	11.18
d		0.39	0.39	0.59	0.79	1.00	1.26	1.57	2.00	2.56	3.15	4.00

WEIGHT												
LBS.	0.34	0.31	0.59	0.81	1.31	2.0	3.0	4.4	9.6	14.5	20.3	

TORQUE RATING												
FT.-LBS.	0.72	0.72	1.30	1.80	2.29	4.33	6.50	8.67	14.46	25.35	36.20	

WORKING PRESSURES			
Working Pressure Non-Shock (psi)		Test Pressure (psi)	
Saturated Steam	Cold Water, Oil, Gas	Shell (Air)	Seat (Air)
150	600*	100	100

*550 psi (1-1/2" & 2") only for UL use

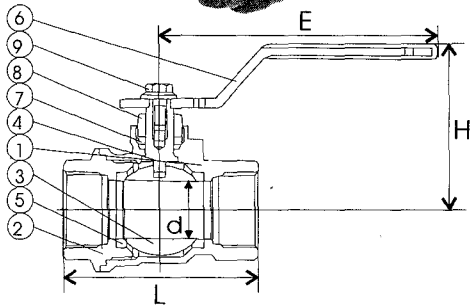

NOTES FOR 5049F

- Dimensions of solder-joint ends conform to ANSI B16.22.
- The maximum recommended pressure-temperature ratings for solder-joints made with copper tube and copper alloy fittings, using representative commercial solders are listed in the table below.
- The safe working pressure-temperature rating for a solder-joint piping system is dependent, not only on fitting and tube strength, but also on the composition of the solder used for joints.

NOMENCLATURE AND MATERIALS

1	Body	Forged brass	ASTM B283-C37700
2	Body end piece	Forged brass	ASTM B283-C37700
3	Ball	Forged brass (Hard chromium plated)	ASTM B283-C37700
4	Stem	Forged brass	ASTM B124-C37700
5	Seat	Teflon®	
6	Lever handle	Steel (Zinc plated)	ASTM A36
7	Gland packing	Teflon® (5044F), Graphoil (5049F)	
8	Gland	Forged brass	ASTM B124-C37700
9	Handle bolt	Steel (Zinc plated)	ASTM A36

® DuPont's Trademark

- SKU** (* = Special Order)
A = 608964
B = 608967
C = 608971
D = 608974
E = 608977
F = 608982

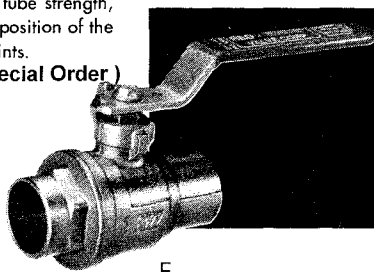

FIGURE #5049F Solder-Ends		DIMENSIONS Unit: inch										
Mark	Size	1/4*	3/8*	1/2	3/4	1	1-1/4	1-1/2	2	2-1/2*	3*	4*
		A	B	C	D	E	F	G	H			
L		-	1.89	2.13	2.83	3.31	3.86	4.53	5.51	6.65	7.72	-
H		-	1.57	2.11	2.24	2.56	2.80	3.27	3.58	4.69	5.12	-
E		-	3.27	3.64	3.64	5.04	5.04	5.63	5.63	11.18	11.18	-
d		-	0.39	0.59	0.79	1.00	1.26	1.57	2.00	2.01	2.50	-

WEIGHT												
LBS.	-	0.36	0.53	0.78	1.22	2.0	2.9	4.3	8.6	13.5	-	-

TORQUE RATING												
FT.-LBS.	-	0.72	1.30	1.80	2.29	4.33	6.50	8.67	32.00	35.55	-	-

WORKING PRESSURES					
Solder Used in Joints	Working Temp. Deg. F	Maximum Working Pressure (psi)		Test Pressure (psi)	
		3/8" - 1"	1-1/4" - 2"	Shell (Air)	Seat (Air)
95-5* Tin Antimony	100	500	400	100	100
	150	400	350		
	200	300	250		
	250	200	175		

*ASTM B32 Alloy Grade 95TA

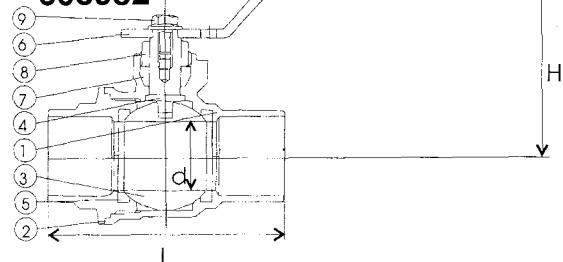

Nomenclature and Materials are common for each item on this page.



CELCON GATE VALVES

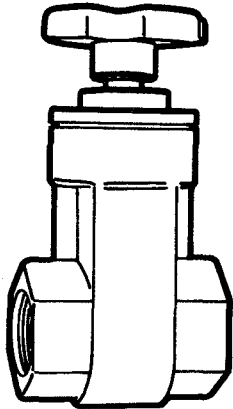

SPECIFICATIONS:

- Heavy duty/non-rising stem construction.
- All plastic material for corrosion resistance.
- Meets ASTM, ANSI and schedule 40 requirements.
- Bronze color body/black wheel handle.
- Viton or EPDM O'ring options.
- Polypropylene wedge for smooth sealing and longer service.
- Made by KBI in U.S.A.
- Full flow operation—1/2" to 2" size range.

SKU	MODELS		
Number		EPDM	Viton
607260	1/2"	GVL-500-E	GVL-500-V
607265	3/4"	GVL-750-E	GVL-750-V
607270	1"	GVL-1000-E	GVL-1000-V
607275	1 1/4"	GVL-1250-E	GVL-1250-V
607280	1 1/2"	GVL-1500-E	GVL-1500-V
607285	2"	GVL-2000-E	GVL-2000-V

PVC BLOCKED TRUE UNION BALL VALVES

SPECIFICATIONS:

- Double Union design allows in-line maintenance without disconnecting pipe.
- One end blocked which prevents ball from being blown out under pressure.
- Ball seats are Teflon to insure ease of operation.
- End connector carrier and stem O'ring are available in either EPDM or Viton.
- Models come with both slip and thread end connectors.
- Meets ASTM Standards, Schedule 80 sockets.

POLYETHYLENE DRUM & BARREL FAUCETS

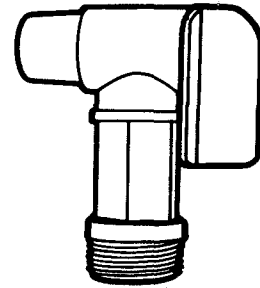

Strong polyethylene construction with excellent chemical resistance properties. Use with water and approved chemicals.

SKU	Complies with ANSI B2.1 Male Pipe Inlet x Plain Outlet		
Number		MODELS	
608295	3/4"	DF-750-T	MIPT x Plain Outlet
608300	2"	DF-2000-T	MIPT x Plain Outlet

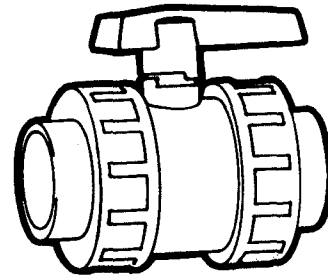

SKU	MODELS		
Number		EPDM	Viton
607290	1/2"	BTU-500-E	BTU-500-V
607295	3/4"	BTU-750-E	BTU-750-V
607300	1"	BTU-1000-E	BTU-1000-V
607305	1-1/4"	BTU-1250-E	BTU-1250-V
607310	1-1/2"	BTU-1500-E	BTU-1500-V
607315	2"	BTU-2000-E	BTU-2000-V

8

COMPRESS UNIONS

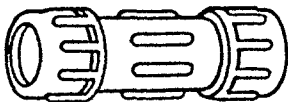

SKU NUMBER	MFG. NUMBER	SIZE
605910	160-103	1/2"
605915	160-104	3/4"
605920	160-105	1"
605925	160-106	1 1/4"
605930	160-107	1 1/2"
605935	160-108	2"
605940	160-110	3"
605945	160-111	4"

DRAIN CAP

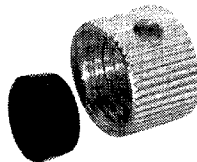

SKU	PART No.
608612	888-209 - Small 5/16"-24
608614	888-352 - Large 3/8" -24

No. 2 "DUO-CLOZ"

Washing Machine Shut-off Valve with Ball-type Construction

Controls both hot and cold water simultaneously protecting machine parts and hoses from damaging effects of water pressure. One "finger-tip" lever ends inconvenience of turning two hand type valves.

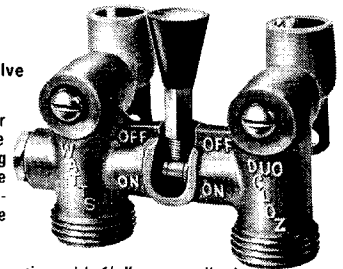

Furnished with bronze body construction with 1/2" copper ell adapters, 2 3/8" on center. Max. Temperature 180°F. Max. Pressure 150 psi. Also available with 2-way male connectors. (1/2" threaded and sweat copper dual adapter.) Specify No. 2T.

SKU	No.	Size	Height	Length	Weight
605399	2T	1/2"	3 1/4"	3 3/4"	1 1/4 lbs.

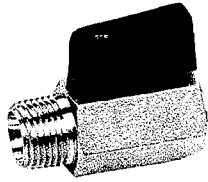

DynaQuip MINI BALL VALVE

The VNH Series mini valves are designed for air, water, fuels, gases and liquids. The space saving bar stock design features bottom loaded stem, chrome plated brass ball and body, PTFE seats and Viton stem seal. Wing shaped nylon handle provides operating ease and a short turning radius, allowing close valve installation. Valve has full NPT threads, made to ANSI-B1.20.1 standards; 450 PSI pressure rating and can be used for a -4° to 200° F temperature range.

SKU	PART No.	SIZE
608921	VNH3-AM	1/4"

PVC SCHEDULE 40 VALVES

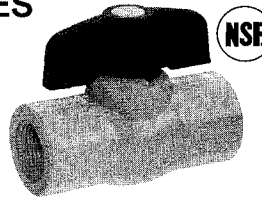

- ISO 9002
- Rated for 150 PSI at 73°F
- NSF approved
- White color
- EPDM seats
- EPDM O-rings
- Fits both Schedule 40 and 80 pipe
- Threaded ends comply with ANSI B1.20.1
- Solvent ends comply with ASTM D2466

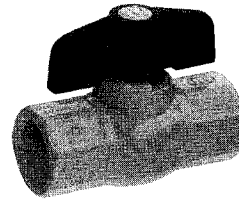

SKU NO.	PART NO.	VALVE SIZE
611633	107-133	1/2"
611636	107-134	3/4"
611639	107-135	1"
611642	107-136	1-1/4"
611645	107-137	1-1/2"
611648	107-138	2"
Solvent		
346737	107-633	1/2"
346764	107-634	3/4"
346722	107-635	1"
346863	107-636	1-1/4"
346877	107-637	1-1/2"

PVC SCHEDULE 40 CHECK VALVE



- Rated for 200 PSI at 73°F
- White color
- Fits both Schedule 40 and 80 pipe
- Spring loaded poppet
- Stainless steel spring
- O-ring seal
- Not for use with compressed air
- Threaded ends comply with ANSI B1.20.1

PART NO.	VALVE SIZE
Threaded	
606553	101-104 3/4"
606556	101-105 1"
606650	70330 3"



HOSE BIBBS - STANDARD

Brass construction, neoprene seal disc, 3/4" hose thread outlet. Pipe threads comply with ANSI B2.1. Hose threads comply with ANSI B2.4.

SKU	Part No.	Type	Size
608595	103-003	Standard	1/2"
608600	103-004	Standard	3/4"

FORGED BRASS • HOSE BIBB • BALL VALVE TYPE

- ISO 9002
- Rated for 200 PSI water, oil or air
- Quarter turn operation
- Chrome plated brass ball
- 3/4" hose thread outlet
- Large flow rate
- Pipe threads comply with ANSI B1.20.1
- Hose threads comply with ANSI B1.20.7

SKU	PART NO.	VALVE SIZE
608598	103-023	1/2"
608601	103-024	3/4"

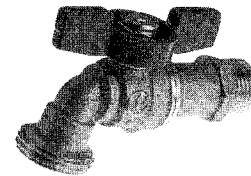

FROSTPROOF ANTI-SIPHON SILLCOCK

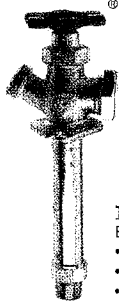

- Chrome plated body and tube
- Meets ASSE standard 1019
- Lead free silver solder construction
- Built in lockshield
- 3/4" hose thread outlet
- Notched flange for stable installation
- Pipe threads comply with ANSI B1.20.1
- Hose threads comply with ANSI B1.20.7
- Solder ends comply with ANSI B16.18

SKU	PART NO.	VALVE LENGTH
637900	104-515	8"
637918	104-517	10"
637926	104-519	12"

TECHNICAL FEATURES

- B&K'S anti-siphon frost free sillcocks protect against back siphoning.
- A built in backflow preventer checks siphoning back into the water supply.
- The sillcock drains automatically upon water shut off, if the hose is removed or open.
- Available with combination 1/2" threaded and 1/2" solder ends.
- For use in single and multi-family residential, commercial and other buildings wherever an outdoor 3/4" hose connection is needed.

FROSTPROOF LAWN FAUCETS

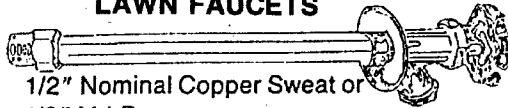

1/2" Nominal Copper Sweat or
1/2" M.I.P.

SKU NO.	MFG. NO.	LENGTH
608980	456-6	6"
608985	456-8	8"
608990	456-10	10"
608995	456-12	12"
609000	456-14	14"



SILLCOCKS

Heavy brass construction, convenient notched flange for stable installation. Neoprene seal disc, 3/4" hose thread outlet, heavy cast iron handle. Pipe threads comply with ANSI B2.1, hose threads comply with ANSI B2.4, solder connections comply with ANSI B16.18.

SKU	Part No.	Type	Size
608580	108-003	Threaded	1/2"
608630	108-004	Threaded	3/4"

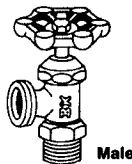

BOILER DRAINS

Heavy brass construction. Neoprene seal disc, 3/4" hose thread outlet, heavy cast iron handle. Pipe threads comply with ANSI B2.1. Hose threads comply with ANSI B2.4.

SKU	Part No.	Type	Size
608605	102-003	Male †	1/2"
608610	102-004	Male	3/4"

Drum & Barrel Faucets

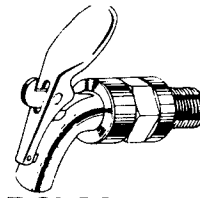

ZAMAC – SELF CLOSING

Zamac (zinc) construction, painted brass color. Convenient hole to lock handle in closed position. For use with all petroleum products, except trichlorethylene. Not for use with detergents or water. 3/4" male pipe thread inlet. Pipe threads comply with ANSI B2.1.

SKU	Part No.	Type	Size
608590	109-204	Plain Outlet	3/4"

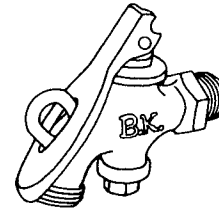

BRONZE

Heavy bronze construction, quarter turn operation with lockable handle, 3/4" male pipe thread inlet available with thread outlet. Pipe threads comply with ANSI B2.1. Hose threads comply with ANSI B2.4.

SKU	Part No.	Type	Size
611606	109-214	Plain Outlet	3/4"
611612	109-224	Hose Thread Outlet	3/4"

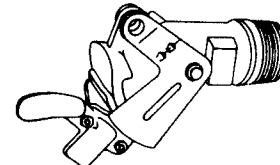

OIL AND MOLASSES GATE VALVES

Malleable iron body, bronze slide, manually operated, lockable. For use in drawing viscous, non-flammable liquids from drums and tanks.

SKU	Part No.	Size
611594	109-404	3/4"
611598	109-407	1 1/2"
611603	109-408	2"

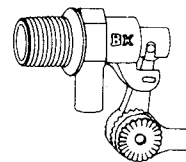

Male Inlet
Plain Outlet

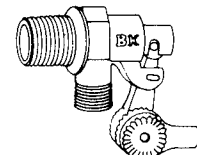

Male Inlet
Pipe Thread Outlet

FLOAT VALVES - BRONZE

Dual inlet thread for connecting pipe and locknut, high tensile serrate arms, machined flange for support against tank wall, replaceable seals, locknut included with male inlet valves.

SKU	Part No.	Type	Size
611612	109-803	Male Inlet - Plain Outlet	1/2"
611614	109-804	Male Inlet - Plain Outlet	3/4"
611617	109-813	Male Inlet - Pipe Thread Outlet	1/2"
611620	109-814	Male Inlet - Pipe Thread Outlet	3/4"

**SHALLOW WELL
 AIR VOLUME CONTROL**

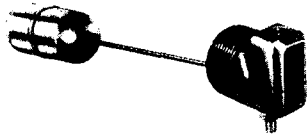

To maintain the correct relation between the volume of air and the quantity of water in pressure tanks. Furnished with air tube and connections. Body threaded for 1 1/4" pipe. Tapped 1/4" pipe size for gauge.

SKU	MFG#
605195	29307A

BRADY CONTROLS

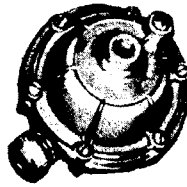

SKU	Model Number	Maximum Tank Size
605465	293076	42 gallons

NO. 5340 FOOT VALVES

All - Brass Spring Foot Valve With Strainer

Recommended for all types of pumps.

Can be furnished for oil and gas when specified.



SKU	Size Pipe Inches	Enters Pipe Inches	Strainer Length Inches
605470	3/4	1 1/4	2-9/16
605475	1	1 1/2	3
605480	1 1/4	2	3-7/16
605485	1 1/2	2 1/2	4-3/8
605490	2	3	5-7/16

hot water boiler relief valve

Series Model 374A

ASME water pressure safety relief valves

- For hot water heating and supply boilers.
- Pressure protection only.
- Series 174A bronze body construction resists corrosive water conditions of water supplies.
- Pressure relief settings 30 to 150 psi (2.1-10.3 bars).

Specifications

- Sizes: 3/4" - 2" (19 - 50 mm), NPT threaded female inlet x female outlet (drain) connection.

- Standard pressure relief settings are 30 psi (206.9 kPa), 100 psi (689.5 kPa), 125 psi (8.6 bars) and 150 psi (10.3 bars) with corresponding BTU/hr. ratings.
- Other valve settings are available in 5 psi (34.5 kPa) increments within the pressure ranges shown.
- Model 374A has iron body with bronze inlet; 550,00 BTU/hr. rating.



SKU	SIZE
145870	3/4"

PRESSURE GAUGES

Pressure gauges for all 4-ported miniature regulators: dial size 1 1/2", back connection 1/8", steel body

Product Number Range

274Z160WS 0-160

SKU NO. 450825



Pressure gauges: dial size 2", back connection 1/4", steel body

Product Number Range

275Y300WS 0-300

SKU NO. 450828



BACKFLOW PREVENTER

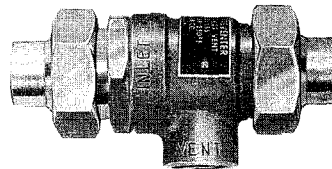

- **Model N9** - Dual check backflow preventer with atmospheric vent. For continuous pressure applications. Sizes: 1/4" (6 mm) and 3/8" (10 mm) NPT female inlet and outlet connections. Max. pressure 125 psi (8.6 bars), brass finish.

Backflow preventers/vacuum breakers

- Used to prevent the flow of contaminated water into the potable water supply.
- Use where water spillage will not cause damage

SKU	MFG No.
605391	N9

ADJUSTABLE RELIEF VALVES



SKU NO. 450831 Mfg. No. 59-02A

water heater t&p safety relief valves

Series 100XL

Self-closing T&P relief valves for hot water storage tanks and heaters

- These combined two-in-one Temperature and Pressure relief valves provide the least expensive and proven means for protection against both excessive temperature and pressure emergency conditions.
- Fully automatic temperature and pressure relief protection for domestic hot water supply tanks and heaters based on the latest ANSI Z21.22 listing requirements for temperature discharge capacity.
- Reliable and proven means of protection against excessive temperature and pressure build-up in domestic hot water systems.
- Includes test lever.
- For water heaters from 15,000 to 100,000 BTU/hr.
- NPT male inlet and female outlet.

Standards

- AGA and ASME Rated; ANSI Z21.22 certified, CGA Listed.

Specifications

- Temperature relief 210°F (99°C). Pressure relief range 75 to 150 psi (5.2-10.3 bars). Standard pressure relief settings: 75 psi (517.1 kPa), 100 psi (6.9 bars), 125 psi (8.6 bars) or 150 psi (10.3 bars).

SKU	MFG. No.	SIZE	100XL
605407	100XL-4-125	125LB 3/4"	
605409	100XL-4-150	150LB 3/4"	
605403	10L-2-150	150LB 3/4" X 2"	
605401	1L-2-150	150LB 1/2" X 2"	



Gas Appliance Connectors



1/2" I.D. (7/8" O.D.) CORRUGATED TUBE **3/8" I.D. (1/2" O.D.) CORRUGATED TUBE**

Recommended for Gas Ranges

SKU		3/4" F.I.P. x 3/4" M.I.P. 24" Length. 1 Per Bag. 28.3"H x 2.9"W x 2.5"D
650597	PSBSC21-24	
650600	PSBSC21-36	36" Length. 1 Per Bag. 12.5"H x 8.3"W x 1.5"D
650603	PSBSC21-48	48" Length. 1 Per Bag. 11.3"H x 9.3"W x 1.6"D
650606	PSBSC21-60	60" Length. 1 Per Bag. 13.3"H x 10.8"W x .9"D
650609	PSBSC21-72	72" Length. 1 Per Bag. 13.3"H x 10.8"W x .9"D

Recommended for Forced Air Heaters, Furnaces & Water Heaters

1/2" F.I.P. x 1/2" M.I.P

SKU		24" Length. 1 Per Bag. 28.3"H x 2.9"W x 1"D
650612	PSBSD54-24	
650615	PSBSD54-36	36" Length. 1 Per Bag. 12.5"H x 8.3"W x .8"D
650618	PSBSD54-48	48" Length. 1 Per Bag. 11.3"H x 9.3"W x .8"D
650621	PSBSD54-60	60" Length. 1 Per Bag. 13.3"H x 10.8"W x .8"D
650622	PSBSD54-72	72" Length. 1 Per Bag. 13.3"H x 10.8"W x .8"D



GAS VALVES - BALL VALVE TYPE

Heavy forged brass construction, one piece body through 3/4", hard chrome plated forged brass ball, coated aluminum handle (3/8"- 3/4") or Dacromet plated steel handle (1" - 2"). Certified by the American Gas Association (3-88) for use with natural, manufactured, mixed, liquified petroleum and LP gas/air mixtures up to 2 PSIG and temperatures up to 175°F. Underwriters Laboratories listed for use with water up to 175 PSI. Designated models are also certified by the Canadian Gas Association. Threaded ends comply with ANSI B2.1

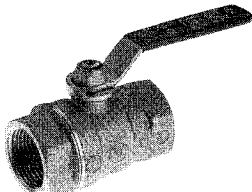

LEVER HANDLE - STEEL

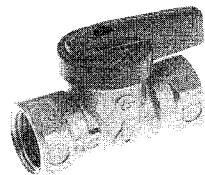

LEVER HANDLE - ALUMINUM

SKU	PART No.	Description	Size
608576	110-525	Lever Handle - AGA / UL / CGA	1"
608656	110-526	Lever Handle - AGA / UL / CGA	1-1/4"
608659	110-527	Lever Handle - AGA / UL / CGA	1-1/2"
608662	110-528	Lever Handle - AGA / UL / CGA	2"
608572	110-523	Lever Handle - Aluminum	1/2"
608574	110-524	Lever Handle - Aluminum	3/4"

GAS APPLIANCE CONNECTORS

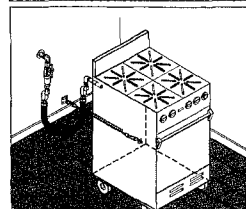
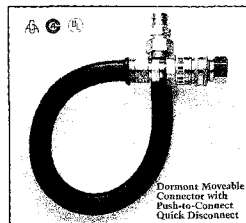

SKU	Part No.	Description
620463	1675BDQ48BX	3/4" Moveable Gas Connector 48"

SKU	Part No.	Description
620461	1675NPKIT48	3/4" Stationary gas connector 48"

Double Supr-Swivel™ Cimfast™ Commercial Gas Range Installation

No. 1L - 10L
1/2" Size

Self-Closing T & P Relief Valves

A compact, economical design for water heaters up to 15,000 BTU/HR. Provides both pressure and temperature relief protection. No. 1L furnished with test lever and short thermostat for installation directly in tank tapping. No. 1XL has test lever and extension thermostat for installation in hot outlet line. Male inlet and female outlet. Pressure range 75-150 lbs. Standard settings 125 and 150 lbs. Temperature relief 210°F. Also available with 8" extension thermostat at small extra cost. Specify No. 1XL-8.

- All bronze body
- Stainless steel spring
- Thermostat is positive, accurate and proven, exclusively designed and manufactured by Watts.

No. 10L - 10XL - Same as above except 3/4" size to meet A.S.M.E. requirements.

ANS Z21.22 DESIGN
 CERTIFIED by A.G.A.
 and C.G.A. LISTED



SKU	No.	Size	Height (Less Thermostat)	Width	A.G.A. Temp. Steam Rating BTU/HR	Model
605396	1L-2	1/2"	3 1/2"	1 7/8"	15,000	M6
605393	10L-2	3/4"	3 1/2"	1 7/8"	80,000	M4

NO. NF8 HOSE CONNECTION VACUUM BREAKER

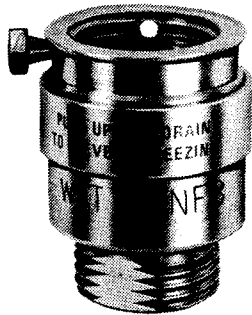

Provides back-siphonage protection for portable hoses connected to hose thread faucets. Especially made for wall and yard hydrants. Permits manual draining for freezing conditions.

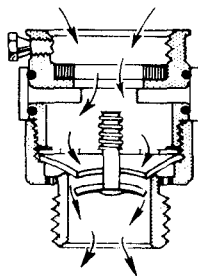

ASSE STD. 1011

SKU	No.	Size	Height	Width
605372	NF8	3/4" HT	2"	1 1/2"



VACUUM BREAKER

SKU	SIZE	Mfg. No.
611678	3/4" GHT	108-904

BLUE RIBBON MODEL

No. 100XL
3/4" Size

Self-Closing T & P Relief Valves

Watts Blue Ribbon Model No. 100XL is identical to No. 10XL, except it features: A UNIQUE THERMOSTAT WITH SPECIAL THERMO-BONDED (NON-METALLIC) PROTECTIVE COATING.

The feature forms a highly protective dielectric barrier which isolates the copper thermostat from the heated water to prevent accumulations of mineral deposits and galvanic corrosive action. This important breakthrough dramatically extends the effective life of the valve by overcoming problems created by adverse water conditions.

No. 100XL has test lever and extension thermostat. Also available with 8" extension at small extra cost, specify No. 100XL-8. Male inlet and female outlet. Temperature Relief - 210°F.

- All bronze body
- Stainless steel spring
- Thermostat with special protective coating.

ASME RATED
 ANS Z21.22 DESIGN
 CERTIFIED by A.G.A.
 and C.G.A. LISTED

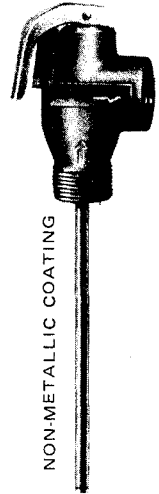

SKU	No.	Size	Height (Less Thermostat)	Width	A.G.A. Temp. Steam Rating BTU/HR	Model
605387	100XL-8	3/4"	3 1/2"	1 7/8"	100,000	M4

BACK FLOW PREVENTER VACUUM BREAKERS

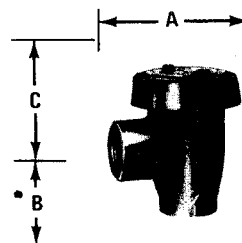

This device is not to be used under continuous pressure. For continuous pressure application, specify Watts No. 800 Series pressure type vacuum breakers. Vacuum Breakers are not designed, tested or approved to protect against backpressure backflow. For protection against backpressure backflow, install Watts No. 900 Series reduced pressure principle backflow preventers.

SKU	No.	Size	Dimensions			Weight
			A	B	C	
605376	288A	1/4"	1 1/16"	1 1/16"	1 3/16"	3/8 lb.
605378	288A	3/8"	1 1/16"	1 1/16"	1 3/16"	3/8 lb.
605381	288A	1/2"	2"	1 3/16"	1 7/16"	1/2 lb.
605384	288A	3/4"	2 1/4"	1 1/2"	1 5/8"	1 1/8 lbs.

FIRE SPRINKLER HEADS



SKU	Mfg. No.	Size	Description
605115	10325		Sprinkler Guard
605108	01016AF	3/4"	Escutcheon
605102	02960AF	1/2"	Escutcheon
605123	04802BAB	1/2"	UPRGT Sprinkler Brass 155°
605129	04802-BAE	1/2"	UPRGT Sprinkler Brass 200°
605096	04804-BFB	1/2"	Sprinkler Head Pend 155°
605099	04806-BFB	1/2"	Sprinkler Head Hori 155°
605117	04824-BAB	3/4"	Sprinkler UPRGT Brass 155°
605126	04824-BAE	3/4"	Sprinkler UPRGT Brass 200°
605114	12ESCC		Chrome Escutcheon for Sprinkler

ZOELLER "53" Cast Iron Series

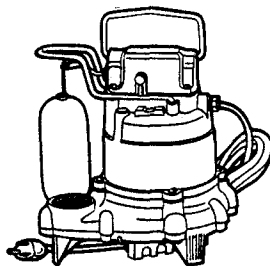

"MIGHTY-MATE"

EFFLUENT OR DEWATERING PUMP
SUBMERSIBLE
PASSES 1/2" SOLIDS 1 1/2" NPT DISCHARGE

Hermetically sealed, oil filled motor. Overload protected. Cast-iron motor and pump housing. Glass filled molded material base, strainer plate switch-cap, and impeller with metal insert. Stainless steel screws and switch arm. No screens to clog. Float operated. Vortex impeller design.

Wt. 23 lbs., Ht. 9 1/2" Major width 9 1/2" 60 cycle AC, 1 Ph.

T.D.H. Ft. | 5 10 15 19.25

Cap. G.P.M. | 43 34 19 0

Volts Cord Length
115 9'

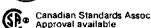

SKU NO. MODEL
608080 M53 Auto.

ZOELLER "267" Series

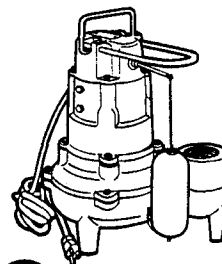

"WASTE-MATE"

SEWAGE OR DEWATERING PUMP
SUBMERSIBLE
PASSES 2" SOLIDS 2" NPT DISCHARGE

Hermetically sealed oil filled motor. Overload protected. Durable cast construction. Cast iron switch cap, motor shell, pump housing, base and impeller. Stainless steel screws, bolts, float rod, handle, guard and arm. Vortex impeller design. Float operated.

Wt. 51 lbs., Ht. 14" Major width 12 1/2" 1/2 HP., 60 cycles, 1 Ph.

T.D.H. Ft. | 5 10 15 20 21.5

Cap. G.P.M. | 128 89 50 10 0

Volts Cord Length
115 10'

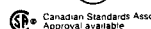

SKU NO. MODEL
608086 M267 Cast-Iron Auto.

REMOVES WATER FROM AREAS WHERE GRAVITY FLOW IS NOT AVAILABLE

Applications include, laundry tray pump, wet bar sink, lavatory, air conditioning condensate or dehumidifier water removal. Also residential dishwashers and garbage disposal applications.

NO INLET FILTERS OR SCREENS TO CLEAN

DRAIN PUMP SERIES INCLUDES:

- Automatic cast iron or brass series pumps with tank cord seal.
- Polyethylene basin and lid. IAPMO Approved.
- Internal discharge pipe to lid.
- Check Valve (30-0181).

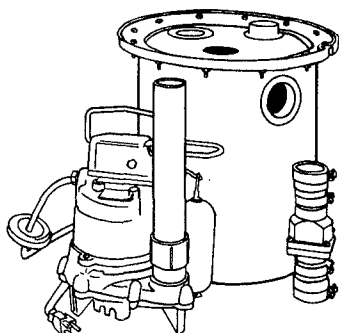

SKU NO.	DRAIN PUMP SERIES	MODEL PUMP WITH BASIN
608082	105	M53

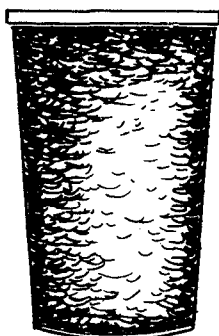

FIBREGLASS SUMP BASIN
ONE-PIECE COVER

SKU NO.	MFG. NO.	SIZE
609502	1400A	18" x 24"

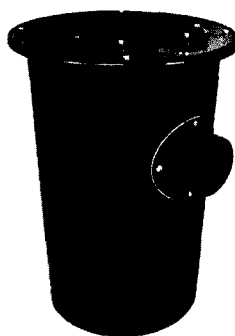

SEWAGE EJECTOR PIT

CAN ALSO BE USED FOR CLEAR WATER SYSTEMS. 4" CAST IRON HUB.

SKU NO.	MFG. NO.	SIZE
605559	30	18 3/4" x 30"

ZOELLER PARTS

SKU NO.	MFG NO.	
600126	002588	Dielectric Oil 2102
608089	004705	Switch Assm. (new)
608411	004740	Ejector Switch
600121	034019	Sump Pump Float
600122	034046	Gasket Swt Cap
600119	034061	Switch Assm (old)
600124	054062	Pump Float Rod
600123	054080	Arm & Seal Assy.
608408	267007	Ejector Cover Gasket

SUMP PUMP CORRUGATED HOSE
1 1/4" DIAMETER PLASTIC HOSE
SUITABLE FOR SUMP PUMP DISCHARGE
ONLY-CANNOT BE USED AS SUCTION LINE

SKU	MFG NO	SIZE
600112	235457	24' KIT W/FTTGS
600113	115904	EACH FOOT

**VIBRATION FREE
UNIONS**

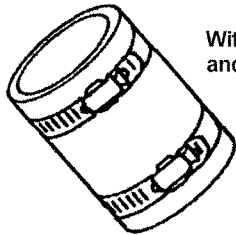

With 6" Hose
and SS Clamps

SKU	PART No.	Size
609503	1160	1-1/4"
609506	1162	1-1/2"
609509	1164	2"

**SUMP PUMP
CHECK VALVES**

SKU NO	MFG NO	SIZE
605051	DJ545	1 1/4" OR 1 1/2"
605054	2GP	2"

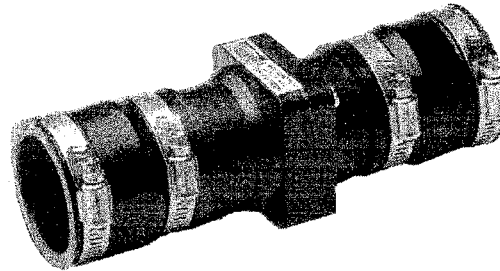

EJECTOR COVER

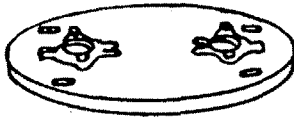

SKU	Size
605553	18"

**SUMP BASIN
COVER**



One hole - Steel

SKU	PART No.	Size
605132	1600	18"

**HYDROMATIC
PRESSURE SWITCH**



SKU	PART No.
607973	12572-000-5

**HOME GUARD
WATER POWERED
PUMP**

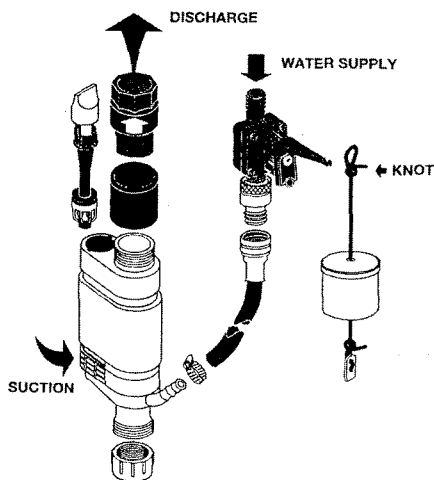

SKU	PART No.
608081	10-0416

**SUMP PUMP
DRAINAGE KIT**

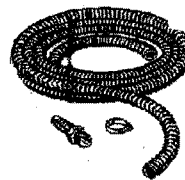

1-1/2" Sump Pump Drainage Kit, Includes 24' White Corrugated Polyethylene Hose, Male Adapter & Clamp, For Permanent Or Temporary Use, 3 Color Bag.

SKU	PART No.	Size
115876	115876	1-1/2"

MODEL BW85P
12 VOLT PORTABLE MINI-VAC

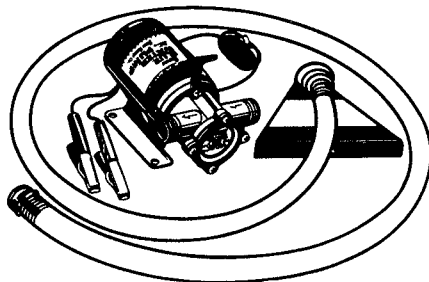

"Pud-L-Scoop" and 6' suction hose included on BW85P model — pumps floors dry to 1/8" 12 volt D.C. permanent magnet type motor Capacities to 10 GPM

Extra impeller kit included at NO CHARGE

SKU No.	Model	Discharge Height Above Pumping Level	0'	10'	20'	30'	35'
608120	BW85/BW85P	Gallons per Minute	10	8.5	6.8	4.4	3

MODEL M40P
115 VOLT PORTABLE MINI-VAC



"WATERBED PUMP"

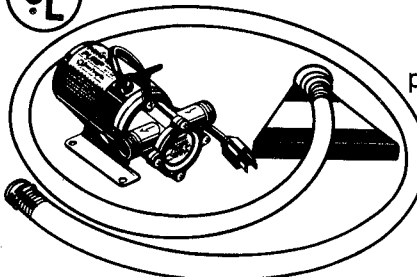

"Pud-L-Scoop" and 6' suction hose included pumps floors dry to 1/8" A252 Impeller Replacement Kit includes impeller, cam ring and gasket A257 Complete Pump End Kit ready to attach to motor

Extra impeller kit included at NO CHARGE

SKU No.	Model	Discharge Height Above Pumping Level	0'	10'	20'	30'	40'
608115	M40/M40P	Gallons per Minute	10	6	4	2.3	5

REPLACEMENT PUMP ENDS AND KIT

SKU No.	MODEL NUMBER	DESCRIPTION
608126	A257	Complete Repl. Pump Head; M40, M40K
608127	A267	Complete Repl. Pump Head; UB85

Geyser Pump Conversion Kit Includes:

- 1-SSS 11 U/L Switch, Complete with Screws, Sensors & Brackets
- 1-MPK Mud Pad for Geyser Pump with Screen
- 1-HCV Check Valve Hose & Adaptor
- Complete instructions

NO MOVING PARTS—No floats, chains or rods to malfunction.

INFINITELY VARIABLE SETTINGS—Adjustable for any high/low water levels, from 3/4" to 6".

SKU No. 608129 MODEL GCK

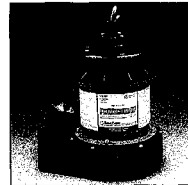
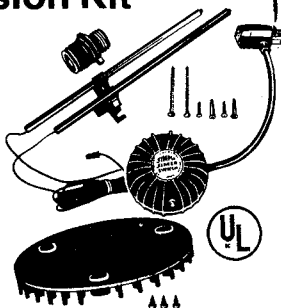

Model 2995

PitMaster IV - 1/2 HP
Submersible Sump / Effluent Pumps

- Rugged cast iron body, corrosion resistant thermoplastic base
- Classic side discharge design
- 1/2 HP, 115 volt, oil cooled motor, 11.3 amps
- Automatic thermal overload protection
- Replaceable 8' cord with grounded plug
- Model 2995G with 25' cord
- 1-1/2" FPT discharge
- Large clearance anti-clog impeller for trouble free operation. Handles solids 3/4" diameter
- Weighs 22 lbs.



Model 2995

- Tethered float switch (non-mercury) with direct to pump plug connection
- Automatic operation; turns on at 14-1/2", off at 7-1/2"
- Minimum sump diameter 15"

PERFORMANCE — Up to 3960 Gallons Per Hour

Discharge Height Above Pumping Level	0'	5'	10'	15'	20'
Gallons per Minute	66	54	44	28	6

SKU 608118

Chuckmaster Drill Pumps

- Pump as much as 6 gallons per minute
- Easy to use. Handles all kinds of small pumping jobs: filling and emptying aquariums, crocks, sinks, tubs, window wells, stopped-up plumbing; emptying crankcases
- Lifts water 10 feet after priming
- Handles household emergencies, plugged drains, etc., quickly and quietly
- Uses regular garden hose fitting (on CM10 only)
- Oil change kit (CMK) comes complete with hose

SKU 744134



Model CM10

GASOLINE POWERED PUMP

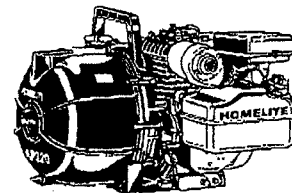

AP-220 3 HP Gas Pump, Briggs & Stratton Engine, 8400 Gph, Chemical & Abrasion Resistant Polyester Designed To Pump Chemicals Or Water, Long Life Carbon Ceramic Seals With Edpm Gaskets, Open Type Impact & Abrasion Resistant Impeller, Check Valve For Easy Priming, Heavy Duty Air Cleaner & Solid State Ignition, Pump Only Requires Hose Fittings & Strainer For Operation.

SKU 692783

MFG. No. AP-220

ADAPTERS



1-1/4" mpt x garden hose
 SKU MFG. No.
 608141 HA5



1-1/4" fpt x garden hose
 SKU MFG. No.
 608143 HA6

FLOAT SWITCHES

Float Switch Models — NM15K, NM17K

- Rated at up to 15 amps
- Piggy-back plug connection for 115 volt operation and with 8' power cord (NM15K, NM16K)
- Ideal for any sump pump
- NM15K normally open — for maintaining vessels empty
- NM17K plugs directly into top of pump (Models 2962, 2963, 2990 and 2995)
- Mounting straps included

SKU MFG. No.
 608128 NM15K
 608130 NM17K

BATTERY OPERATED BACK-UP SUMP PUMPS

SKU NO 601106

MFG NO BWS-12

BATTERY FOR ABOVE 7.5 HOUR CAPACITY

SKU NO 601109

MFG NO 30HDC140S

MODEL 2305

GEYSER II



1/6 HP, 115 volt motor — U.L. Listed
 Rugged thermoplastic body resists corrosion, impact, stress and heat
 8' cord with grounded plug
 Oil filled Simer motor provides high efficiency
 Built-in thermal overload protection
 Replaceable power cord feature
 Vent relief prevents airlock
 1-1/4" NPT discharge with garden hose adapter included
 Pumps floor dry to 1/8"
 Portable — weighs only 9 lbs.

SKU Number	MFG Model	0'	5'	10'	15'	20'	25'
608133	2305	25	21	17	15	9	3

MODEL 2300

GEYSER III CLASSIC



Heavy duty 1/6 HP, 115 volt motor
 Epoxy coated aluminum body resists heat, oil and corrosion
 Internal thermal overload protection
 Model 2300 has 8' cord with grounded plug
 Model 2310 comes with a 25' cord
 Open type trash impeller resists clogging
 Removable screen for easy cleaning
 1-1/4" NPT discharge with brass fitted garden hose adapter
 Replaceable power cord
 Pumps water down to 1/8" of floor
TWO YEAR warranty Weighs only 9 lbs.



SKU Number	MFG Model	0'	5'	10'	15'	20'	25'
608090	2300	25	21	17	15	9	3

MODEL 2355

SUPER GEYSER VX

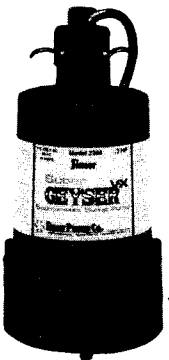

.3 HP, 115 volt motor
 Engineered thermoplastic "Valox" body is impact, stress, heat and corrosion resistant
 8' cord with grounded plug
 Oil filled, cool running motor
 Pumps floor dry to 5/8"
 Power cord is replaceable
 1-1/4" discharge with garden hose adapter Weighs only 10 lbs.

SKU Number	MFG Model	0'	5'	10'	15'	20'	25'
608138	2355	44	37	34	26	19	6

MODEL P3010

12 VOLT GEYSER



12 volt, DC battery powered
 Thermoplastic construction/corrosion resistant
 1-1/4" discharge with garden hose adapter
 8' DC cable leads included
 Weighs 9 lbs.



SKU Number	MFG Model	0'	5'	10'	15'	20'	25'
608110	P3010	26	24	22	18	15	10

Pitmaster Submersible Sewage Ejector Pumps

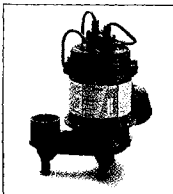

Model 2962

- Heavy duty cast iron motor housing (and pump volute on Model 2963)
- 1/2 HP, 115 Volt, thermal overload protected motor
- Reliable non-mercury float switch
- Corrosion-resistant pump, volute and impeller
- Stainless steel motor shaft
- Replaceable 8 ft. power cord with grounded plug
- Minimum basin diameter 18"
- 2" NPT discharge connection

Pitmaster L - Model 2962 - 1/2 HP
 ■ Anti-clog vortex impeller passes solids up to 1-5/8" in diameter
 ■ Automatic operation; 16" on, 8" off

SKU
608108

PitMaster III - 1/3 HP Submersible Sump/Effluent Pumps

- Rugged cast iron body; corrosion resistant thermoplastic base
- Universal side discharge design
- High capacity 1/3 HP, 115 volt, oil cooled motor, 9.5 amps
- Automatic thermal overload protection
- Replaceable 8 ft. cord with grounded plug
- Anti-clog impeller for trouble free operation. Handles solids 1/2" diameter
- 1-1/4" FPT discharge
- Weighs 21 lbs.

Model 2990

- Tethered float switch (non-mercury) with direct to pump plug connection
- Automatic operation; turns on at 14", off at 7"
- Minimum sump diameter 14"

SKU
608102



Model 2990

8



SKU Number	MODEL NUMBER	DESCRIPTION
608131	2900	Replacement Cord, 8'
608132	2910	Replacement Cord, 25'



SKU Number	MODEL NUMBER	DESCRIPTION
608123	A252	Impeller Replacement Kit; M40, M40K
608124	A270	Impeller Replacement Kit; UB85, BW85

SKU
Number
608128



- Piggy-back plug connection for 115 volt operation
- 10 ft. power cord
- Ideal for any sump pump
- NM15K normally open — for maintaining vessels empty
- NM16K normally closed — for maintaining vessels full
- Mounting straps included

GALVANIZED PIPE



SKU NUMBER	MFG NUMBER	DESCRIPTION
GALV 2FT SNAPLOCK PIPE		
650966	110203	3" 30GA GLV PIPE 2' LGTH
650969	110204	4" 30GA GLV PIPE 2' LGTH
650972	110205	5" 30GA GLV PIPE 2' LGTH
650975	110206	6" 30GA GLV PIPE 2' LGTH
650978	110207	7" 30GA GLV PIPE 2' LGTH
650981	110208	8" 30GA GLV PIPE 2' LGTH
650984	120209	9" 28GA GLV PIPE 2' LGTH
651011	120210	10" 28GA GLV PIPE 2' LGTH
651014	120212	12" 28GA GLV PIPE 2' LGTH

GALV 5FT SNAPLOCK PIPE

650993	110503	3" 30GA GLV PIPE 5' LGTH
650996	110504	4" 30GA GLV PIPE 5' LGTH
650999	110505	5" 30GA GLV PIPE 5' LGTH
651002	110506	6" 30GA GLV PIPE 5' LGTH
651005	110507	7" 30GA GLV PIPE 5' LGTH
651008	110508	8" 30GA GLV PIPE 5' LGTH
651009	120209	9" 28GA GLV PIPE 2' LGTH
650987	120210	10" 28GA GLV PIPE 2' LGTH
650990	120212	12" 28GA GLV PIPE 2' LGTH

GALVANIZED ELBOWS

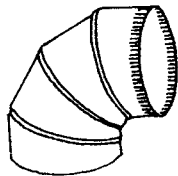

GALV 90 ADJ ELBOWS

651017	111403	3" 30GA GLV ADJ EL
651020	111404	4" 30GA GLV ADJ EL
651023	111405	5" 30GA GLV ADJ EL
651026	111406	6" 30GA GLV ADJ EL
651029	111407	7" 30GA GLV ADJ EL
651032	111408	8" 30GA GLV ADJ EL
651035	121409	9" 28GA GLV ADJ EL
651038	121410	10" 28GA GLV ADJ EL
651041	121412	12" 24GA GLV ADJ EL

GALVANIZED FITTINGS

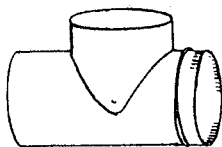

26GA TEES- 24" LONG

GALV 764-1/2 28GA TEES-12" LONG

651056	128121	764-1/2 3 ON 3 TEE 28GA
651059	128125	764-1/2 4 ON 4 TEE 28GA
651062	128128	764-1/2 5 ON 5 TEE 28GA
651065	128130	764-1/2 6 ON 6 TEE 28GA
651068	128131	764-1/2 7 ON 7 TEE 28GA
651044	138120	764 8 ON 8 TEE 26GA
651050	138122	764 10 ON 10 TEE 26GA
651053	138123	764 12 ON 12 TEE 26GA

EXCELSIOR

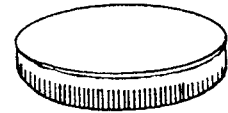

GALV 767 END CAPS-S.E.

651074	129610	767 3" END CAP SE
651077	129611	767 4" END CAP SE
651080	129612	767 5" END CAP SE
651083	129613	767 6" END CAP SE
651086	129614	767 7" END CAP SE
651089	129615	767 8" END CAP SE
651092	129616	767 9" END CAP SE
651095	129617	767 10" END CAP SE
651098	129618	767 12" END CAP SE

GALV 790 SCREW TYPE DRAWBANDS

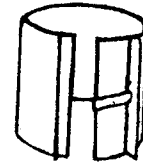

651071 139719 790 6" SCREW TYPE DRAWBAND

GALV 771 START COLLARS S.E.-2IN

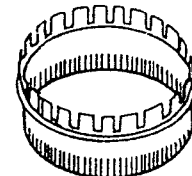

651101	113103	771 3" STARTING COLLAR SE
651104	113104	771 4" STARTING COLLAR SE
651107	113105	771 5" STARTING COLLAR SE
651110	113106	771 6" STARTING COLLAR SE
651113	113107	771 7" STARTING COLLAR SE
651116	113108	771 8" STARTING COLLAR SE
651119	113109	771 9" STARTING COLLAR SE
651122	113110	771 10" STARTING COLLAR SE
651125	113112	771 12" STARTING COLLAR SE

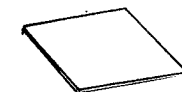

GALVANIZED SHEET METAL

SKU NO.	GAGE	SHEET SIZE
651489	30	3' x 3'
651488	28	3' x 8'

GALVANIZED PRODUCTS

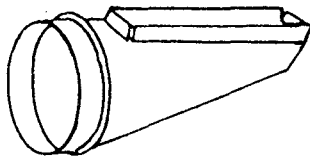

SKU NUMBER	MFG NUMBER	DESCRIPTION
GALV 750S END STACK BOOTS		
651368	114410	750S 6" 2-1/4X10 END BOOT
651371	114411	750S 6" 3-1/4X10 END BOOT
651374	114412	750S 6" 2-1/4X12 END BOOT
651377	114413	750S 6" 3-1/4X12 END BOOT

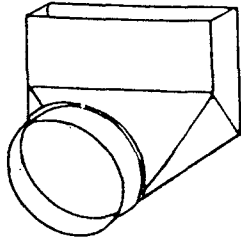

GALV 710R ANGLE REGISTER BOOTS

651380	115110	710R 6" 2-1/4X10 ANGLE BOOT
651383	115112	710R 6" 2-1/4X12 ANGLE BOOT
651386	115109	710R 6" 4X10 ANGLE BOOT
651389	115118	710R 6" 4X12 ANGLE BOOT
651392	115115	710R 6" 6X10 ANGLE BOOT
651395	115114	710R 6" 6X12 ANGLE BOOT

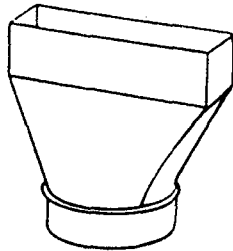

GALV 708R STRAIGHT REGISTER BOOTS

651473	115712	6" REGISTER BOOT 2 1/4" x 12"
651485	115714	6" REGISTER BOOT 6" x 12"
651482	115715	6" REGISTER BOOT 6" x 10"
651476	115717	6" REGISTER BOOT 4" x 10"
651479	115718	6" REGISTER BOOT 4" x 12"

GALVANIZED REDUCERS / INCREASERS

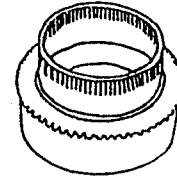

GALV 797 ROUND CAP REDUCERS STYLE "A"

651239	128251	797 4-3" CAP REDUCER
651242	128252	797 5-3" CAP REDUCER
651248	128253	797 5-4" CAP REDUCER
651245	128254	797 6-3" CAP REDUCER
651251	128255	797 6-4" CAP REDUCER
651254	128256	797 7-6" CAP REDUCER SE-LE
651257	128259	797 7-5" CAP REDUCER
651260	128260	797 7-6" CAP REDUCER
651263	128264	797 8-6" CAP REDUCER
651266	128265	797 8-7" CAP REDUCER
651269	128270	797 9-7" CAP REDUCER
651272	128271	797 9-8" CAP REDUCER
651275	128277	797 10-8" CAP REDUCER
651281	128278	797 10-9" CAP REDUCER
651278	128284	797 12-8" CAP REDUCER
651284	128286	797 12-10" CAP REDUCER

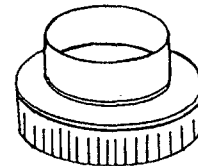

GALV 797 ROUND CAP INCREASERS STYLE "A"

651287	128287	797 3-4 CAP INCREASER
651290	128288	797 3-5 CAP INCREASER
651293	128289	797 4-5 CAP INCREASER
651296	128291	797 4-6 CAP INCREASER
651299	128292	797 5-6 CAP INCREASER
651302	128295	797 5-7 CAP INCREASER
651305	128296	797 6-7 CAP INCREASER
651306	128300	797 6-8 CAP INCREASER
651308	128301	797 7-8 CAP INCREASER
651311	128305	797 7-9 CAP INCREASER
651314	128306	797 8-9 CAP INCREASER
651317	128310	797 8-10 CAP INCREASER
651320	128311	797 9-10 CAP INCREASER
651323	128316	797 10-12 CAP INCREASER

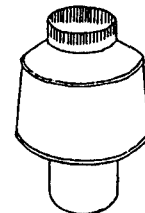

GALV VERTICAL DIVERTERS

651215	136103	753 3" VERT. DIVERTER STD
651218	136104	753 4" VERT. DIVERTER STD
651221	136105	753 5" VERT. DIVERTER STD
651227	136107	753 7" VERT. DIVERTER STD

GALVANIZED STACK

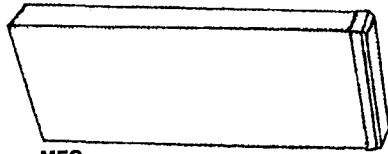

SKU NUMBER	MFG NUMBER	DESCRIPTION
GALV 720-5FT STACK		
651416	112520	720-5 2-1/4X10 STACK 5' LGTH
651410	112530	720-5 3-1/4X10 STACK 5' LGTH
651419	112522	720-5 2-1/4X12 STACK 5' LGTH
651413	112532	720-5 3-1/4X12 STACK 5' LGTH

651131	112220	DUCT 2' 2 1/4" x 10" 2 PC/SET
651137	112222	DUCT 2' 2 1/4" x 12" 2 PC/SET
651143	112224	DUCT 2' 2 1/4" x 14" 2 PC/SET
651134	112230	DUCT 2' 3 1/4" x 10" 2 PC/SET
651140	112232	DUCT 2' 3 1/4" x 12" 2 PC/SET
651146	112234	720-2 3-1/4X14 STACK 2' LGTH

LONG ELBOW

SKU NO.	MFG NO.	SIZE
651212	119166	3 1/4" x 14"

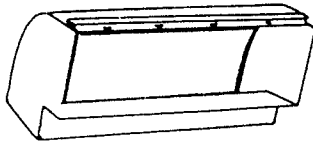

GALV 718 STACK 90 SHORTWAY ELBOWS

651161	119151	718 2-1/4X10 SHORTWAY EL
651164	119152	718 3-1/4X10 SHORTWAY EL
651167	119153	718 2-1/4X12 SHORTWAY EL
651170	119154	718 3-1/4X12 SHORTWAY EL
651173	119155	718 2-1/4X14 SHORTWAY EL
651176	119156	718 3-1/4X14 SHORTWAY EL

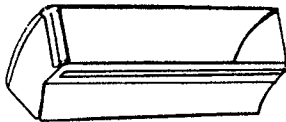

GALV 721 STACK 45 SHORTWAY ELBOWS

651179	119201	721 2-1/4X10 45' SHORTWAY EL
651182	119202	721 3-1/4X10 45' SHORTWAY EL
651185	119203	721 2-1/4X12 45' SHORTWAY EL
651188	119204	721 3-1/4X12 45' SHORTWAY EL
651191	119205	721 2-1/4X14 45' SHORTWAY EL
651194	119206	721 3-1/4X14 45' SHORTWAY EL

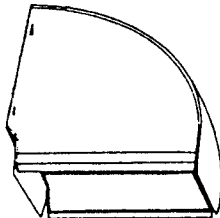

GALV 729 STACK 90 FLATWAY ELBOWS

651197	119161	729 2-1/4X10 90' FLATWAY EL
651200	119162	729 3-1/4X10 90' FLATWAY EL
651203	119163	729 2-1/4X12 90' FLATWAY EL
651206	119164	729 3-1/4X14 90' FLATWAY EL
651209	119165	729 2-1/4X14 90' FLATWAY EL

EXCELSIOR

GALVANIZED DUCT END CAPS & PRODUCTS

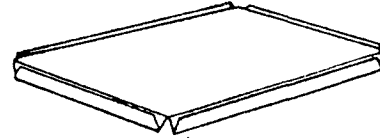

SKU NUMBER	MFG NUMBER	DESCRIPTION
GALV 799 STACK END CAPS		
651341	119736	799 3-1/4X14 END C

651326	119731	2 1/4" x 10"	RECTANGULAR END CAP
651329	119732	3 1/4" x 10"	RECTANGULAR END CAP
651332	119733	2 1/4" x 12"	RECTANGULAR END CAP
651335	119734	3 1/4" x 12"	RECTANGULAR END CAP
651338	119735	2 1/4" x 14"	RECTANGULAR END CAP

GALV 701 STACK STARTING COLLARS

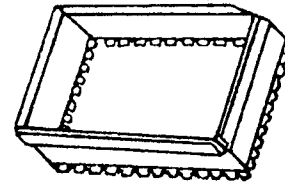

651149	119021	701 2-1/4X10 STARTING COLLAR
651152	119022	701 3-1/4X10 STARTING COLLAR
651155	119023	701 2-1/4X12 STARTING COLLAR
651158	119024	701 3-1/4X12 STARTING COLLAR

GALV 731 "S" CLEATS

651398	139481	731 12" S CLEAT
651401	139483	731 16" S CLEAT

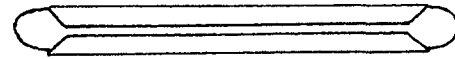
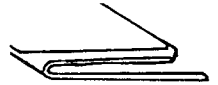

GALV 733 DRIVE CLEATS

651404	139495	733 10" DRIVE CLEAT
--------	--------	---------------------

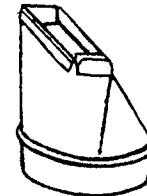

GALV 708S STRAIGHT STACK BOOTS

651344	114110	708S 6" 2-1/4X10 STR BOOT
651347	114111	708S 6" 3-1/4X10 STR BOOT
651350	114112	708S 6" 2-1/4X12 STR BOOT
651353	114113	708S 6" 3-1/4X12 STR BOOT

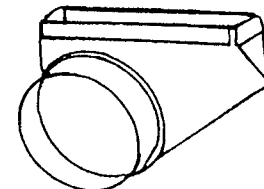

GALV 710S ANGLE STACK BOOTS

651356	114210	710S 6" 2-1/4X10 ANGLE BOOT
651359	114211	710S 6" 3-1/4X10 ANGLE BOOT
651362	114212	710S 6" 2-1/4X12 ANGLE BOOT
651365	114213	710S 6" 3-1/4X12 ANGLE BOOT



421 Floor Diffuser

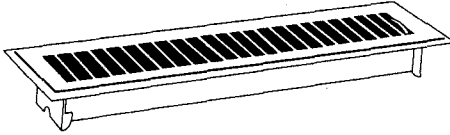

SKU #	MFG PART #	SIZE	COLOR
650744	421-2 X 10	2" X 10"	sand
650747	421-2 X 12	2" X 12"	brown
650750	421-2 X 14	2" X 14"	brown
650753	421-4 X 10	4" X 10"	brown
650756	421-4 X 12	4" X 12"	brown
650759	421-4 X 14	4" X 14"	brown
650762	421-6 X 10	6" X 10"	brown

651 Register

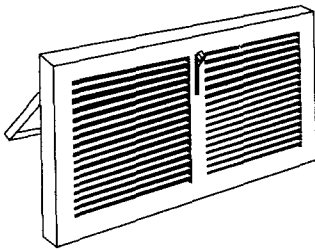

SKU #	MFG PART #	SIZE	COLOR
650801	651-10 X 6	10" X 6"	white
650807	651-14 X 6	14" X 6"	white

406 Baseboard Diffuser

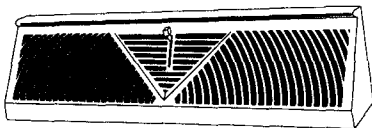

SKU #	MFG PART #	SIZE	COLOR
650855	406	18"	white

411 Deluxe Floor Diffuser

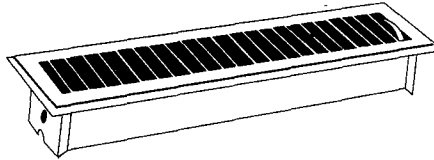

SKU #	MFG PART #	SIZE	COLOR
650765	411-6 X 12	6" X 12"	brown
650768	411-6 X 14	6" X 14"	brown

265 Return Air Grille



SKU #	MFG PART #	SIZE	COLOR
650810	265-4 X 12	4" X 12"	white
650813	265-6 X 10	6" X 10"	white
650816	265-6 X 12	6" X 12"	white

650 & A650 Return Air Grille

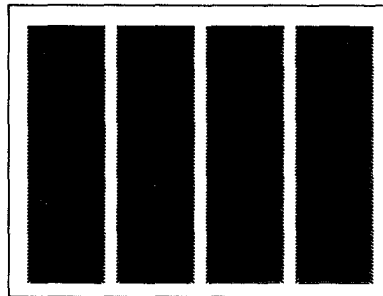

SKU #	MFG PART #	SIZE	COLOR
650447	650-10 x 8	10" X 8"	white
650450	650-10 X 10	10" X 10"	white
650453	650-10 X 24	10" X 24"	white
650456	650-12 X 12	12" X 12"	white
650459	650-14 X 14	14" X 14"	white
650462	650-16 X 10	16" X 10"	white
650465	650-16 X 16	16" X 16"	white
650468	650-20 X 20	20" X 20"	white
650470	650-24 X 10	24" X 10"	white
650471	650-24 X 12	24" X 12"	white
650483	650-6 X 6	6" X 6"	white
650486	650-8 X 4	8" X 4"	white
650489	650-8 X 8	8" X 8"	white
650492	650-10 X 4	10" X 4"	white
650495	650-10 X 6	10" X 6"	white
650498	650-12 X 4	12" X 4"	white
650501	650-12 X 6	12" X 6"	white
650504	650-14 X 4	14" X 4"	white
650507	650-14 X 6	14" X 6"	white
650510	650-14 X 8	14" X 8"	white

420 Toe-Space Grille

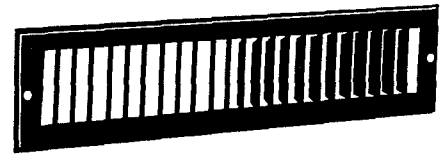

SKU #	MFG PART #	SIZE	COLOR
650771	420-10 X 2	10" X 2"	white
650774	420-10 X 4	10" X 4"	white
650777	420-12 X 2	12" X 2"	white
650780	420-12 X 4	12" X 4"	white
650783	420-14 X 2	14" X 2"	white
650786	420-14 X 4	14" X 4"	white

664 Baseboard Register

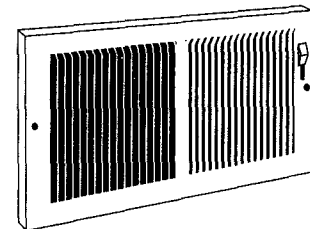

SKU #	MFG PART #	SIZE	COLOR
650852	664-10 X 6	10" X 6"	white

661 & A661 Register

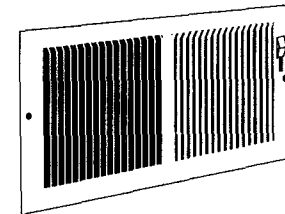

SKU #	MFG PART #	SIZE	COLOR
650819	661-8 X 4	8" X 4"	white
650822	661-8 X 6	8" X 6"	white
650825	661-10 X 4	10" X 4"	white
650828	661-10 X 6	10" X 6"	white
650831	661-10 X 8	10" X 8"	white
650834	661-12 X 4	12" X 4"	white
650837	661-12 X 6	12" X 6"	white
650840	661-12 X 8	12" X 8"	white
650843	661-14 X 4	14" X 4"	white
650846	661-14 X 6	14" X 6"	white
650849	661-14 X 8	14" X 8"	white

16 Ceiling Diffuser

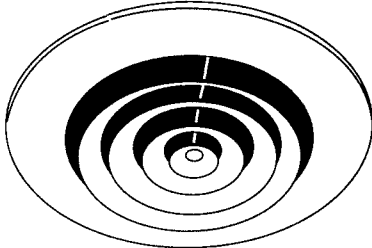

SKU #	MFG PART #	SIZE	COLOR
650858	16-6	6"	white
650861	16-8	8"	white
650864	16-10	10"	white
650867	16-12	12"	white

Collar For Ceiling Lay In

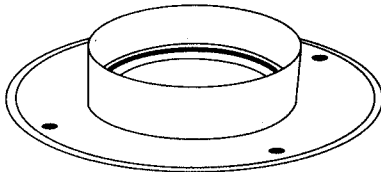

SKU #	MFG PART #	SIZE
651494	5406	6"
651496	5408	8"

11 Duct Ring

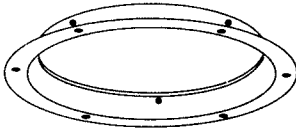

SKU #	MFG PART #	SIZE
650789	11-6	6"
650792	11-8	8"
650795	11-10	10"
650798	11-12	12"

12 Butterfly Damper

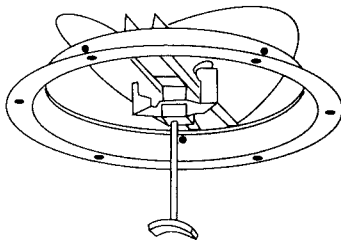

SKU #	MFG PART #	SIZE
650870	12-6	6"
650873	12-8	8"
650876	12 X 10	10"
650879	12 X 12	12"

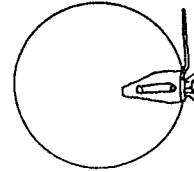

SKU NUMBER	MFG NUMBER	DESCRIPTION
651202	119518	741 6" SNGL BRNG DAMPER

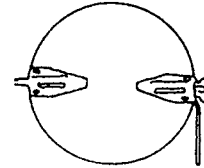

SKU NUMBER	MFG NUMBER	DESCRIPTION
651205	119520	741 8" DBL BRNG DAMPER

STOVE PIPE DAMPERS

SKU	CAST IRON	SIZE
650891	792	4" - C
650894	794	6" - C
650897	796	8" - C

STOVE PIPE COLLARS

SKU	SIZE
650900 448	6"
650903 449	8"

GALV 790 SCREW TYPE DRAWBANDS

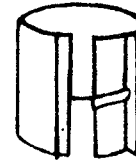

651071	139719	790 6" SCREW TYPE DRAWBAND
--------	--------	----------------------------

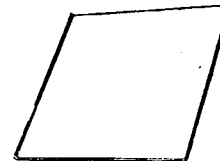

30 GAUGE SHEET METAL	
651489	3' x 3'
651488	3' x 8' 28 Gauge

One-Piece 4 Way Face
And Insulated Back

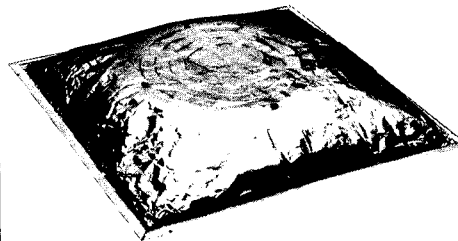

SKU #	MFG PART #	SIZE
651492	444	2' X 2'

VOLUME DAMPER

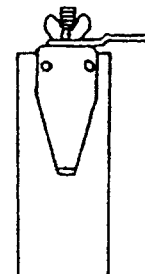

651487	4"
--------	----

ALUMINUM PIPE



SKU

650888 228 3" Diameter x 24" Long Aluminum Lock Pipe

650924 P4E4' DIAMIN 2 x 24' LONG ALUMIN LOCK PIPE

ALUMINUM ELBOW

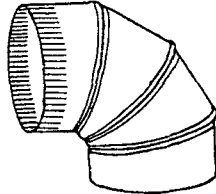

SKU NO.

650928 4" x 90°

ALUMINUM ADAPTORS



SKU

650882 250 Aluminum Increaser - 3" to 4"

650885 251 Aluminum Reducer - 4" to 3"



COMPRESSED FLEXIBLE ALUMINUM DUCT

650906	301	3" Flexible Aluminum Duct - 8' Compressed
650909	302	4" Flexible Aluminum Duct - 8' Compressed
650912	304	5" Flexible Aluminum Duct - 8' Compressed
650915	306	6" Flexible Aluminum Duct - 8' Compressed
650918	308	7" Flexible Aluminum Duct - 8' Compressed
650921	310	8" Flexible Aluminum Duct - 8' Compressed
650957	317	10" Flexible Aluminum Duct - 8' Compressed

CONNECTORS FOR FLEXIBLE ALUMINUM

SKU



650939	243	3" Connector for Flex Alum. Duct
650942	244	4" Connector for Flex Alum. Duct
650945	245	5" Connector for Flex Alum. Duct
650948	246	6" Connector for Flex Alum. Duct
650951	247	7" Connector for Flex Alum. Duct
650954	248	8" Connector for Flex Alum. Duct

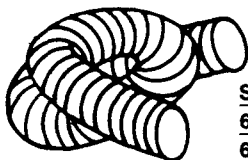

FLEXIBLE VINYL HOSE

SKU

650357	2150	3" x 50' Flex Vinyl Hose
650354	219	4" x 50' Flex Vinyl Hose
650930	FDS10E	5" x 10' FLEX VINYL HOSE
650933	FD610E	6" x 10' FLEX VINYL HOSE

Bulk supurr-FLEX® Ducting



FOR DRYER VENTING & EXHAUST DUCTING



FLEXIBLE UNINSULATED ALUM HOSE

4-inch diameter, 25 ft. length Bulk in Display Carton

SKU NO.	MFG. NO.	SIZE
650936	314-104	4" x 25"
650544	N5	5" x 25"
650500	314106	6" x 25"
650547	N8	8" x 25"

INSULATED FLEX DUCT METALIZED POLYESTER JACKET

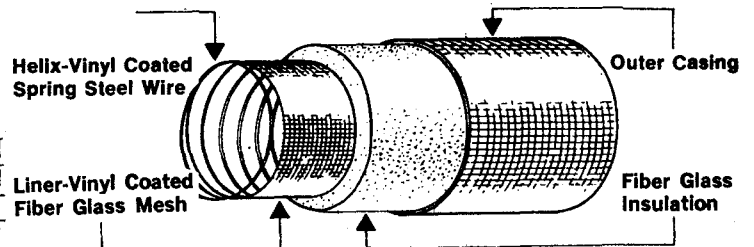

CERIAFLEX INSULATED DUCT

650871	6NT-25M	6" x 25'
650872	8NT-25M	8" x 25'





VENT HOODS
 All Aluminum
 Vent Hoods with
 Standard Tail

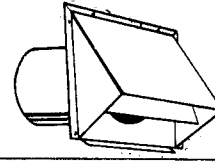

WALL CAPS

SKU	MODEL#	DESCRIPTION
650351	343	3" All Aluminum Hood - Std Tall Piece
650348	344	4" All Aluminum Hood - Std Tall Piece
650360	LPVB4E10	4" White W/12" Duct

SKU	MODEL#	DESCRIPTION
650129	345	5" Aluminum Wall Cap, Damper Spring Controlled
650132	346	6" Aluminum Wall Cap, Damper Spring Controlled
650135	347	7" Aluminum Wall Cap, Damper Spring Controlled
650138	348	8" Aluminum Wall Cap, Damper Spring Controlled



SKU	MODEL#	DESCRIPTION
652004	360B	5" Brown Louver Vent
652003	361B	6" Brown Louver Vent



SKU	MODEL#	DESCRIPTION
652005	2676W	4" White Louver Vent Face Only
652006	2677B	4" Brown Louver Vent Face Only



SKU	MODEL#	DESCRIPTION
652008	141	3" Bathroom Fan Eave Vent 6" Square Flange + 3" Long
652007	142	4" Bathroom Fan Eave Vent 6" Square Flange + 3" Long



SKU	MODEL#	DESCRIPTION
650144	106	3-1/4" x 10" Aluminum Wall Cap with Damper

WALL LOUVERS

FLUSH FLANGE

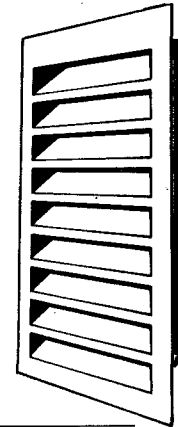

SKU	MODEL#	DESCRIPTION
650378	DA12-12	
650381	DA12-18	



WINDOW PLATES



SKU	MODEL#	DESCRIPTION
650372	236	12" x 18" Aluminum Window Plate, 3" Hole
650369	238	15" x 20" Aluminum Window Plate, 4" Hole

REPLACEMENT VENT CAP



SKU	MODEL#	COLOR
650366	VHR4W	White

LINT TRAP KIT

For Clothes Dryers

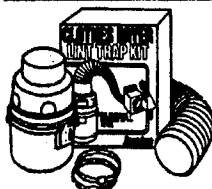

(Kit Includes: 4" x 5' Vinyl Duct, Lint Trap, 2 Clamps and Screw on Hanger)

An Alternative to venting out of doors. Lint Trap bucket has a concave bottom for maximum efficiency.

SKU	MODEL#
650345	211

ADJUSTABLE LOUVERS

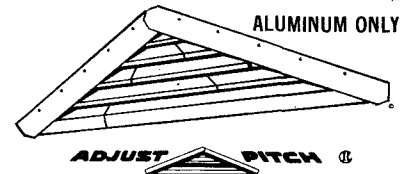

SKU	Size	Pitch Range
650519	L-40 30-92 SQ"	3/12-8/12

UNDER-EAVE LOUVERS

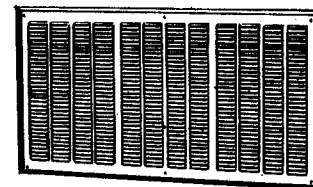

SKU	Size
650513	E10 16" X 14"
650516	E20 16" X 18"



VENT CONNECTION OR SEAL



Connect-or-Seal™

Model No.	Finish
656	White Polyethylene Plastic

Connect-or-Seal™ end cap/connector combination is constructed of a closed-cell extruded semi-rigid polyethylene plastic called Ethafoam.* Ethafoam brings a tough resiliency to the end cap/connector helping it to retain its shape yet be flexible enough to make it easy to work with. It is an excellent barrier to the transmission or penetration of water vapor (even when Connect-or-Seal™ is totally immersed, essentially all the water pickup measured is accounted for by the open cells on the surface). Connect-or-Seal™ is very stable and is not significantly affected within temperature ranges of -40°F to +180°F. It comes in black and white and must be ordered separately.

SKU NO. 650426

ROOF VENTS

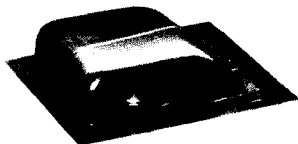

No. 405.

Model No.	Finish	Opening Size Inches	Base Dimensions Inches	Free Area Sq. In.	Will Ventilate* Sq. Ft.
405A 6P	Aluminum	7 1/2	13 1/2 x 16	37	77

SKU NO. 650429

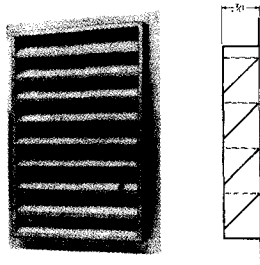

Reversible Rectangular Ventilators

Model No.	Finish	Opening Size Inches	Overall Dimensions Inches	Free Area Sq. In.	Will Ventilate* Sq. Ft.
416 6P	Aluminum	8 x 12	10 1/2 x 14 1/2	34	71
		8 x 16	10 1/2" x 18 1/2"	45	94

SKU NO.	MFG. NO.	SIZE	OVERALL DIMENSIONS INCHES	TYPE
650420	416	8" x 12"	10 1/2" x 14 1/2"	ALUM
650423	416	8" x 16"	10 1/2" x 18 1/2"	ALUM

FOUNDATION VENTS

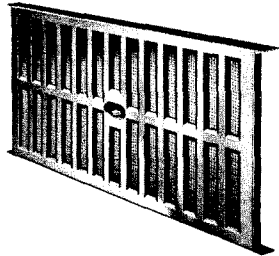

Stamped Aluminum

Model No.	Finish	Size Inches	Damper	Screen	Free Area Sq. In.	Will Ventilate* Sq. Ft.
632R	Aluminum	16 x 8	Alum.	8-Mesh	32	34

*Square feet of area ventilated @ 1/150 ratio – multiply by 10 for 1/1500 ratio.

Sliding damper adjusts to vary free area. Heavy-gauge aluminum damper seals tight when closed, slides to any open position. Fits 16x 8 inch masonry opening.

SKU NO. 650441

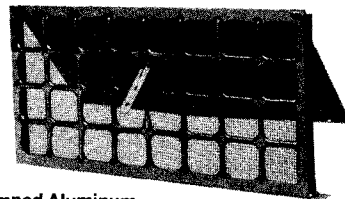

Stamped Aluminum

Model No.	Finish	Size Inches	Damper	Screen	Free Area Sq. In.	Will Ventilate* Sq. Ft.
462R	Aluminum	16 x 8	Alum.	8-Mesh	63	65

*Square feet of area ventilated @ 1/150 ratio – multiply by 10 for 1/1500 ratio.

This die formed foundation vent features a hinged damper (optional) and is more impact resistant than either cast aluminum or plastic. Damper opens inward and has pivots that extend through the frame so they can't slip out. Reinforced top serves as lintel. Eight-mesh screen meets F.H.A. requirements.

SKU NO. 650438

ALUMINUM UNDEREAVE VENT

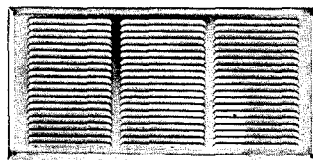

No. 622

SKU NO.	SIZE
650513	4" x 16"
650435	6" x 16"
650516	8" x 16"

UNDEREAVES VENTS

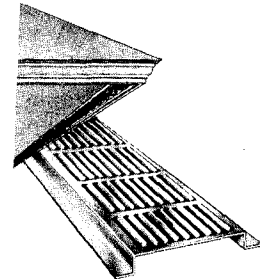

No. 648

Model No.	Finish	Opening Size Inches	Free Area Sq. In.	Will Ventilate* Sq. Ft.
648R	Aluminum	96 x 2	90	188

*Square feet of area ventilated @ 1/300 ratio – divide by 2 for 1/150 ratio.

This Trimvent can be installed flush or recessed before or after soffit boards are in place. Vent openings 1/8 inch wide X 1 inch long. Use Trimvent as an inlet to pull in cool, fresh air. For best results, team up with roof or ridge vents to draw warm humid air out.

SKU NO. 650432

MINIATURE VENTS

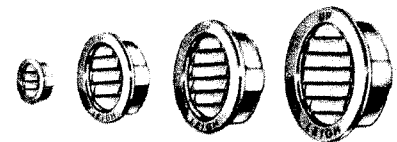

SKU NO.	Model No.	Finish	Size Inches	No. of Louvers	Free Area Sq. In.
651001	2410R	Aluminum	1	3	.18
651003	2420R	Aluminum	2	6	.47
651004	2430R	Aluminum	3	11	1.34
651006	2440R	Aluminum	4	16	2.88

Miniature vents provide the only practical way to release damp, dead air from small completely enclosed areas, such as spaces between studs. Stop paint peeling. Installs in seconds.

WHERE TO GET IT?
If you can't find it
in our catalog check us
out at our website at:
addisononline.com
or e-mail us at:
abmsls@aol.com

GALV 785 RAIN CAPS

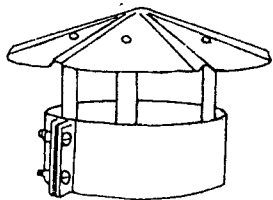

SKU NUMBER	MFG NUMBER	SIZE
651437	139691	785 7" RAIN CAP
651440	139692	785 8" RAIN CAP
651443	139693	785 9" RAIN CAP
651446	139694	785 10" RAIN CAP
651449	139695	785 12" RAIN CAP

GALV 801 RAIN CAPS

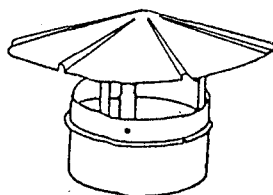

SKU NUMBER	MFG NUMBER	SIZE
651425	139781	801 3" RAIN CAP
651428	139782	801 4" RAIN CAP
651431	139783	801 5" RAIN CAP
651434	139784	801 6" RAIN CAP

RF Adjustable Roof Flashing

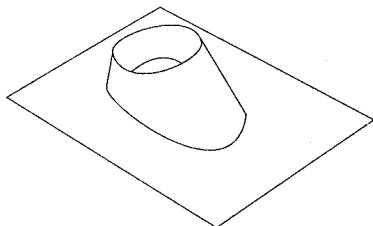

SKU #	MFG PART #	SIZE
650552	3RF	3"
650555	4RF	4"
650558	5RF	5"
650561	6RF	6"
650564	8RF	8"

RM Metcap 3"-12"

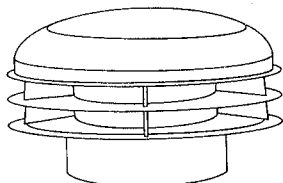

SKU #	MFG PART #	SIZE
650522	3RM	3"
650525	4RM	4"
650528	5RM	5"
650531	6RM	6"
650534	8RM	8"

RP Round Pipe 3" — 8"

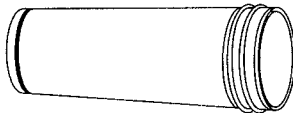

Double wall metal vent insulated gas vent system

SKU #	MFG PART #	SIZE
650567	3RP24	3" X 24"
650570	4RP24	4" X 24"
650573	5RP24	5" X 24"
650576	6RP24	6" X 24"
650579	8RP24	8" X 24"
650582	3RP5	3" X 60"
650585	4RP5	4" X 60"
650588	5RP5	5" X 60"
650591	6RP5	6" X 60"
650594	8RP5	8" X 60"

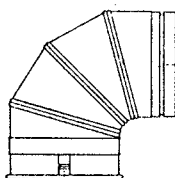

Double Wall Metal vent Insulated Gas Vent System

90° ELL TYPE B

SKU #	MFG PART #	SIZE
650514	3REA90	3"
650502	4REA90	4"
650511	5REA90	5"
650508	6REA90	6"

TURBINE VENTILATOR

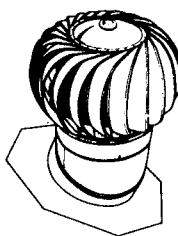

SKU
650375 GC12WB

ROOF LOUVERS

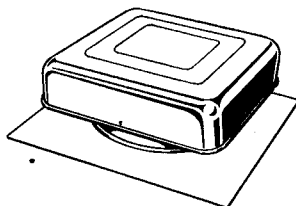

SKU
650123 R-50

RS Storm Collar 3"-6"

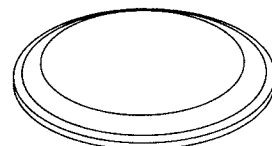

RS Storm Collar 7"-24"

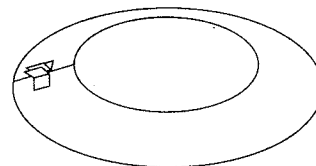

SKU #	MFG PART #	SIZE
650537	3RS	3"
650540	4RS	4"
650543	5RS	5"
650546	6RS	6"
650549	8RS	8"

RWT Wall Thimble

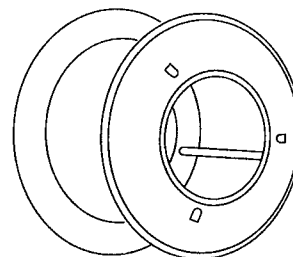

SKU #	MFG PART #	SIZE
650729	3RWT	3"
650732	4RWT	4"
650735	5RWT	5"
650738	6RWT	6"
650741	8RET	3"

VERSACAP

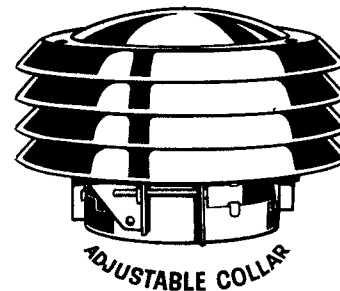

SKU	Size
650390 3050	27/8" X 5"
650393 5070	47/8" X 7"
650396 7090	67/8" X 9"
650399 9011	87/8" X 11"