

TRADELINE

T87F Designer Round

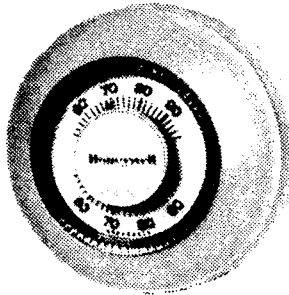

Provides temperature control for 24 to 30 volt residential heating, cooling, or heating-cooling systems.

ELECTRICAL RATINGS:

Mercury Switch: Full Load—1.5 A at 30 Vac.

Adjustable Heat Anticipator: 0.1 to 1.2 A.

Cooling Anticipator: 0 A to 1.5 A, 24 to 30

SKU NUMBER	MFG NUMBER	Diameter		Range	
		in.	mm	F	C
501965	*T87F4002	3-1/4	83	40 to 90	4 to 32
501975	T87F with wallplate or subbase	3-11/16	94		

Q539 Designer Subbase

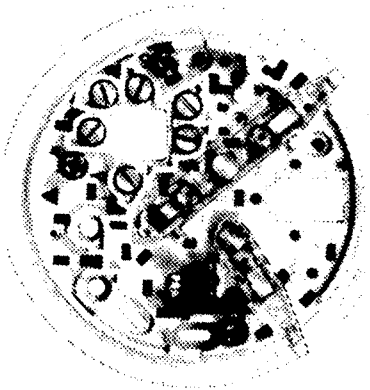

Textured designer model provides system and fan switching and mounting for T87F designer thermostat.

Fan	Switching System
ON-AUTO	COOL-OFF-HEAT

Independent heat-cool circuits.

For conventional single transformer heating-cooling systems.

7



Commercial Timers

Spring Wound Timers are available in SPST, SPDT and DPST contact configurations. Models with a "hold" position provide continuous service without utilizing the timer.

Spring Wound Timer

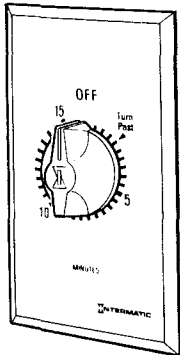

Model FF15M (15 minutes)

GIVES YOU MORE CONTROL OF YOUR ENERGY UTILIZATION

- Full range of switch ratings. Direct control of most loads.
- Upfront wiring with teeter terminals.
- Compact design. Installs in most 2½" deep junction boxes.
- Improved knob and insert design - eliminates broken or lost knobs.

SKU NUMBER	MFG NUMBER	DESCRIPTION COMPLETE
502425	FF5M	Single Gang
502435	FF15M	Single Gang
502445	FF60M	Single Gang
502455	FF12H	Single Gang
502465	FF30M	Single Gang
500584	FF60MH	Time Switch wo/ Hold

PARTS & ACCESSORIES

PLASTIC TIMER KNOBS

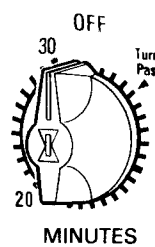

MINUTES

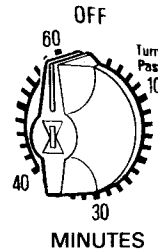

MINUTES

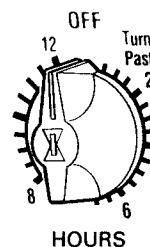

HOURS

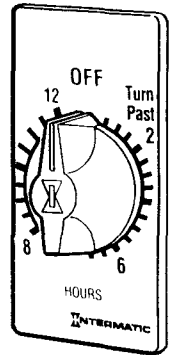

SKU NUMBER	MFG NUMBER	DESCRIPTION
512525	146MT417A	Timer knobs black D center
512530	146MT388	Timer knobs black split
512535	146MT415A	Timer knobs white D center
512538	146MT381	Timer knobs white split

TIMER TRIPPERS

SKU NUMBER	MFG NUMBER	DESCRIPTION
500589	156T1950A	On-Off Tripper
512500	156T1978A	T100 Series Trippers
512505	156T1948A	T170 Series Trippers
512510	156EB1945A	Timer Trippers EB11

MOTORS

SKU NUMBER	MFG NUMBER	DESCRIPTION
512515	WGH430010	For T100 Series
512520	WGH433-3	For E1000 Series



LV500

Replacement Lamps and Bulbs

LV500: Floodlight lamp, sonic sealed, 11 watt. Replacement lamp for current models LF107, LV101, LV103, LV104, LV105, and LV172, and most other Malibu floodlights.

SKU NUMBER	MFG NUMBER	DESCRIPTION
501147	LV500	Malibu light 12V 11 watts

DIMMERS ROTARY & TOGGLE

SKU	MFG#	WATTS	TYPE	COLOR
503003	1100	600 WATTS	ROTARY	IVORY
503022	8300B	600 WATTS	SLIDE 3 WAY	BROWN
503021	8300I	600 WATTS	SLIDE 3 WAY	IVORY

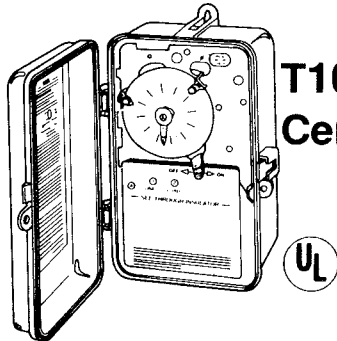

**T100 Series
 Century, 24 Hour Dial**



SKU NUMBER	MODEL NUMBER	SWITCH	CLOCK MOTOR VOLTS 60 Hz.	AMPS. (per pole)	H.P. RATING
502355	T101	SPST	125	40	2
502365	T102	SPST	208-277	40	5
502375	T103	DPST	125	40	2
502385	T104	DPST	208-277	40	5
502395	T101B	SPST	125	40	2
502405	T102B	SPST	208-277	40	5

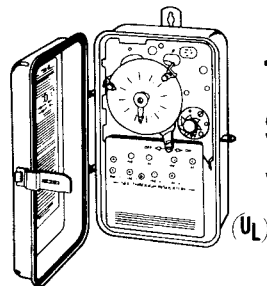

**T170 Series
 Skipper, 24 Hour Dial with Skipper**



SKU NUMBER	MODEL NUMBER	SWITCH	CLOCK MOTOR VOLTS 60 Hz.	AMPS. (per pole)	H.P. RATING
502415	T171	SPST	125	40	2
502387	T173	DPST	125	40	2

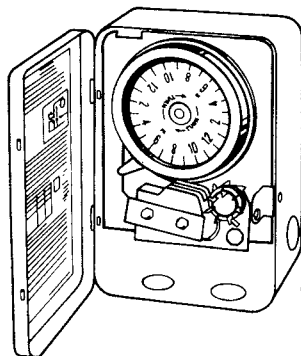

**T1900 Series
 Supervisor, 24 Hour Dial with Skipper and Carry-Over**



SKU NUMBER	MODEL NUMBER	SWITCH	CLOCK MOTOR VOLTS 60Hz.	SPRING-WOUND CARRY-OVER	AMPS.	SKIPPER WHEEL
512495	T1975	SPDT	125	No	20	No

**K1100 Series
 Relay Photo Controls with Adjustable Stem Mounting**

The K1100 Series gives you a choice of wattage and voltage for practically any application. An adjustable stem permits mounting at almost any angle up to 80 degrees. Relay operation for instant switching.

SKU NUMBER	MODEL	WATTS		VOLTS
		Tungsten	Ballast*	
502515	K1121	1800	1800	105-130
502525	K1122	1800	1800	210-240

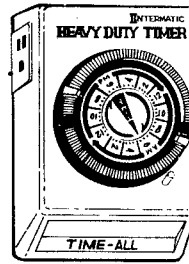

**TIME-ALL®
 HEAVY-DUTY,
 GROUNDED
 PLUG-IN LAMP
 & APPLIANCE
 TIMER**

120 volts, 15 amps—
 Turns air conditioners,
 computers, other heavy-
 duty loads ON and OFF
 every 24 hours.

SKU NUMBER 512485
 MFG NUMBER HB111C
 HB112C Receptacle



512490 HB112C

**ALL WEATHER
 TIME-ALL®**

Controls outdoor lighting, swimming pool pumps, and more.

- Multiple programming with up to 12 ON and 12 OFF settings per day.
- 24 hour portable automatic timer.
- Fully grounded 3 wire system.
- Heavy gauge, weather-proof steel case protects timer.
- Includes two sets of ON/OFF trippers.
- Includes heavy duty 3 ft. cord.
- Capacity: 120V, 1440 Watts, 12 Amps.

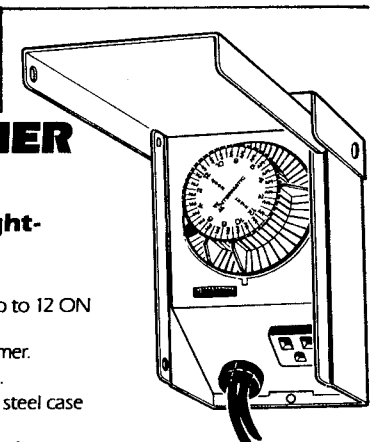

SKU NUMBER 512480
 MFG NUMBER EB11R

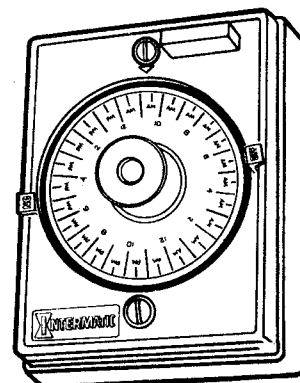

**HEAVY-DUTY
 WALL SWITCH
 SECURITY
 TIMER**

Automatically controls lights and appliances.

- Up to 12 ON and 12 OFF settings per day (model 1020B).
- Single ON/OFF cycle per day (model E1010B).
- Heavy duty load capacity.
- Easy to install.
- Provides security and convenience.
- Replaces any standard wall switch.
- For single pole (1 switch) use only.

SKU NUMBER 502475
 MFG NUMBER E1010B

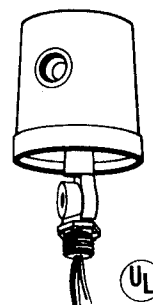

5 Year
 Warranty





TIME-ALL® PROGRAMMER PLUG-IN LAMP AND APPLIANCE TIMER

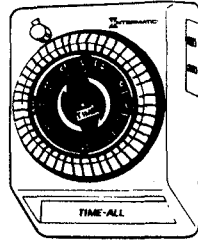

Turns lamp, tv or radio ON and OFF with 48 settings daily.

- Up to 24 ON and 24 OFF settings per day.
- Multiple daily programming of lamps and appliances.
- Plugs into any wall outlet.
- Heavy duty load capacity.
- Manual ON/OFF switch overrides automatic setting when desired.
- Gives your home a lived-in look.

SKU NUMBER 512455 MFG NUMBER SB811C

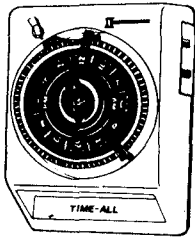

TIME-ALL® RANDOM PLUG-IN LAMP AND APPLIANCE TIMER

Turns lamp or radio ON and OFF at different time each day to give home a lived-in look.

- Two ON and OFF settings per day.
- Automatically controls lamps and appliances.
- Random setting turns ON and OFF at slightly different times each day to avoid predictable "timer controlled" look.
- Manual ON/OFF switch overrides automatic setting when desired.
- Plugs into any wall outlet.
- Heavy duty load capacity.
- Gives your home a lived-in look.

SKU NUMBER 512460 MFG NUMBER SB711C

TIME-ALL® PLUG-IN LAMP & APPLIANCE TIMER



Turns lamp, tv or radio ON and OFF every 24 hours.

- Automatically controls lamps and appliances.
- Single ON/OFF setting per day.
- Plugs into any wall outlet.
- Heavy duty load capacity.
- Manual ON/OFF switch overrides automatic setting when desired.
- Gives your home a lived-in look.

SKU NUMBER 512465 MFG NUMBER SB111C

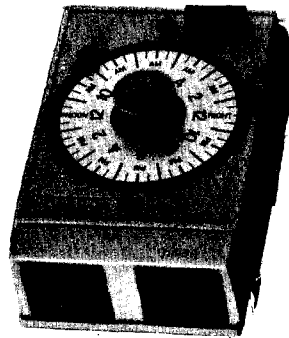

IN WALL TIMERS

Built-in wall switch and outlet timers equipped with 24-hour dial divided in half-hour increments.
12 Hours-On
12 Hours-Off

- Switch SPST
- Amps 15
- Watts 1800



SKU NUMBER 502505 MFG NUMBER E1012C

SKU NUMBER 502485 502495 MFG NUMBER E1020 E1022

TIME-ALL® TABLETOP LAMP AND APPLIANCE TIMER

- Automatically controls lamps and appliances.
- Single ON/OFF setting per day.
- Attractive tabletop styling with 5 ft. cord.
- Plugs into any wall outlet.
- Heavy duty load capacity.
- Manual ON/OFF switch overrides automatic setting when desired.
- Gives your home a lived-in look.

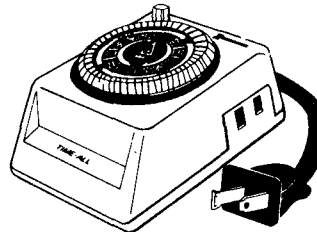

Turns lamp, tv or radio ON and OFF with 48 settings daily.

SKU NUMBER 512470 MFG NUMBER TB811C

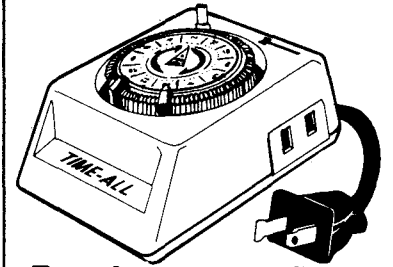

Turns lamp, tv or radio ON and OFF every 24 hours.

SKU NUMBER 512475 MFG NUMBER TB111C

TIME-ALL® PROGRAMMER TABLETOP LAMP AND APPLIANCE TIMER

- Up to 24 ON and 24 OFF settings per day.
- Multiple daily programming of lamps and appliances.
- Attractive tabletop styling with 5 ft. cord.
- Heavy duty load capacity.
- Manual ON/OFF switch overrides automatic setting when desired.
- Give your home a lived-in look.

LIGHT SOCKET AUTOMATIC SECURITY LIGHT CONTROL

- Screws into any light socket.
- Needs no seasonal adjustment.
- For exterior and interior lights.
- No annoying flickering.
- Easy to install.
- For incandescent light bulbs up to 150 watts only.
- Energy saving device reduces brightness by 50%.

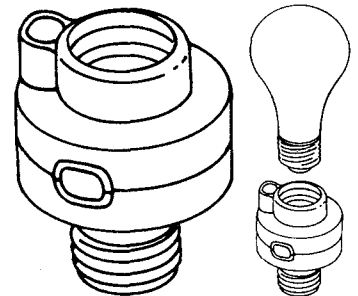

Automatically turns light ON at dusk, OFF at dawn.

SKU NUMBER 500583 MFG NUMBER NE2C

Mulberry

Direct Wire-in Photo Controls

- Lexan® enclosure
- Single pole single throw switch
- Standard turn on 1 foot candle
- UL listed
- Swivel adjustable

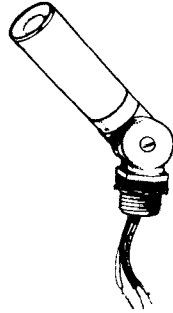

**Durable Lexan® Construction
 Suitable For Wet Locations**

SKU NUMBER	MFG NUMBER	Voltage	Tungsten Rating	Ballast V.A.
500023	30820†*	120	1200W	1100

Protect Floodlighting

Create a stylish modern bullet for less than 1/2 the price.

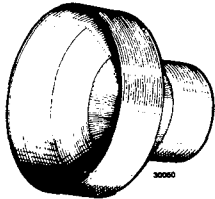

Con-O-Shade™ converts the standard Mulberry #30010 lampholder in an esthetically pleasing modern bullet, upgrading new and existing installations and providing a shield for lamp protection.

- Constructed of heavy die cast aluminum.
- Available in baked aluminum or black.

SKU NUMBER	MFG NUMBER	Aluminum
507050	30050	

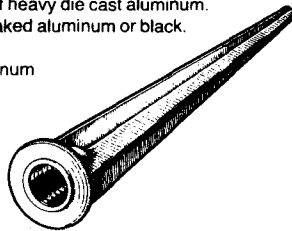

Spike

FEMALE SPIKE / Catalog No. 30298
 1/2" I.P.S. female thread. 7" long, for PAR type lampholders.

SKU NO. 508710



CLOSE-UP PLUG

Die Cast

SKU NUMBER	MFG NUMBER	SIZE	SKU NUMBER	MFG. NUMBER	SIZE
507060	30290	.50"	507070	30294	1"
507065	30292	.75"			



SPACERS (FERRULES) / Fibre

For spacing standard switches when used with weatherproof switch covers

SKU NUMBER	MFG NUMBER
505905	40495

RUBBER GASKETS



1 Gang switch MFG NUMBER
 SKU # — 509500 — 30671



1 Gang duplex receptacle MFG NUMBER
 SKU # — 509485 — 30661



2 Gang duplex receptacle MFG NUMBER
 SKU # — 509495 — 30662

Photo Controls Direct Wire-in, "AT" Series Suitable For Wet Locations

- Die cast aluminum case, SAT features Lexan® housing.
- Hermetically sealed photocell.
- Turn on, turn off ratio: 1 to 3.
- Standard turn on: 1 foot candle.
- Operating levels: .50 to 10 foot candles.
- Minimum time delay: 15 seconds.
- Single pole, single throw switch.
- Temperature range: -50°F to +150°F.
- Contact position at night: normally closed.
- Power consumption: below 1.5 watts average.
- Field adjustable light level.
- Standard 1/2" I.P.S. pipe thread nipple.
- Color coded leads, 6" standard, with wiring diagram marked directly on control.

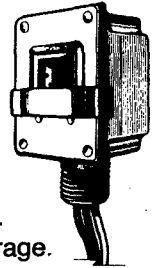

"AT" Series

SKU NUMBER	MFG NUMBER	Voltage	Tungsten Rating	Ballast V.A.
505870	30825†*	120	2000W	1900
505880	30830†*	208-277	2000W	1900
505885	30833*	105-285	2000W	
505900	30847	120	3000W	

†UL listed.
 *CSA approved.

Photo Controls Direct Wire-in, "AA" Series Suitable For Wet Locations

- Threaded, 3/4" long, male nipple for standard 1/2" KO.
- Turn on, turn off ratio: 1 to 3.
- Standard turn on: 2 foot candles.
- Minimum time delay: 20 seconds.
- Single pole, single throw switch.
- Temperature range: -30°F to 140°F.
- Contact position at night: normally closed.
- Color coded leads, 6" standard, with wiring diagram with each control.

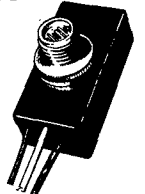

SKU NUMBER	MFG NUMBER	Voltage	Tungsten Rating	Ballast V.A.
505875	30850†*	120	1200W	1100

Photo Controls Lock Type Mounting "BF" Series Suitable For Wet Locations

- Sturdy, high impact plastic housing.
- Meets NEMA standards for locking devices
- Hermetically encapsulated photo cell.
- Turn on-turn off ratio: 1 to 4.
- Standard turn on: 1 foot candle.
- Operating levels: .50 to 10 foot candles.
- Minimum time delay: 15 seconds.
- Single pole, single throw switch.
- Temperature range: -50°F to +150°F.
- Night contact position: normally closed.
- Power consumption: below 1.5 watts average.

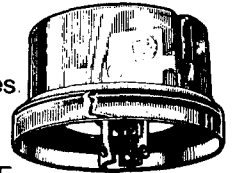

SKU NUMBER	MFG NUMBER	Voltage	Tungsten Rating
505895	30834†*	120	1800W

INCANDESCENT DIMMERS — ROTARY ON/OFF/CAPS

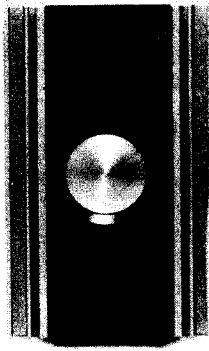

Model No. 8
 800 Watt 120 VAC 60 HZ
 Single Pole-Single Throw
 SKU NO. 503036

Model No. 10
 1000 Watt 120 VAC 60 HZ
 Single Pole-Single Throw
 SKU NO. 503039

- UL Listed.
- Low voltage start-up solid state circuitry.
- 15 Amp semi-conductor.
- 150 Amp semi-conductor surge current rating.
- Heavy-duty toroid for maximum radio frequency interference protection.
- Silver alloy switch contacts.
- Reliable low-intensity operation.
- Individually tested for full operation at factory.
- Fits single wall box.
- Break-away fins for multiple ganging and spacing accommodations.

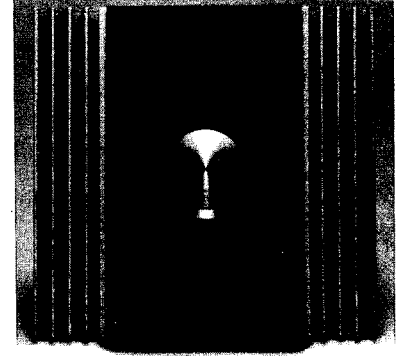

Model No. 15
 1500 Watt 120 VAC 60 HZ
 Single Pole-Single Throw
 SKU NO. 503042

Model No. 20
 2000 Watt 120 VAC 60 HZ
 Single Pole-Single Throw
 SKU NO. 503048

INSTALLATION DIAGRAM

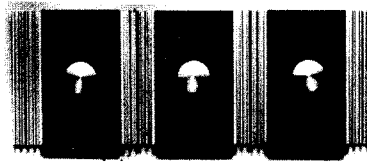
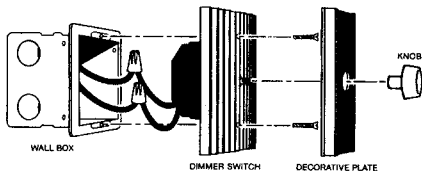

WIRING DIAGRAM

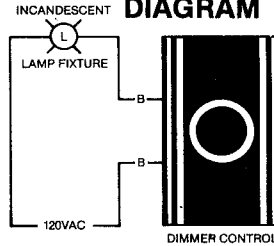

GANGING

This dimmer is designed with a special aluminum heatsink having breakoff points to accommodate multiple ganging in any combination. The location of these breakoff points is located in the dimensional diagram, and by snapping off left, right or both fins, it is possible to gang mount Hybrinetics Dimmers in various combinations while using minimum wall space. Any number of dimmers may be ganged following this procedure.

7

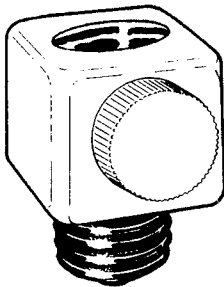

Lamp Socket Dimmer

MODEL #510
 200 Watts/120VAC

- Screw-in lamp dimmer for full range fingertip dimming
- No installation required—screws into lamp socket
- UL listed
- Saves electricity
- Extends bulb life

SKU NO. 503024

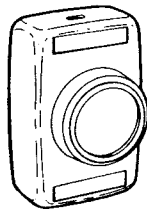

Cord Dimmer

MODEL 620
 300 Watts Max. 120VAC/60Hz

- Full range lamp dimmer to table, swag, and pole lamps. Simple installation - snaps on the lamp cord.
- UL listed.
- Available in white.
- Saves electricity.
- Extends bulb life.

SKU NO. 503033

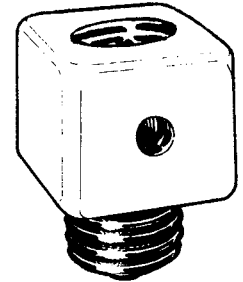

Solar Lamp Control

MODEL #520
 150 Watts Max. 120 VAC

- Light sensitive control that automatically turns lights on at dusk—off at dawn
- No installation required—screws into lamp socket
- UL listed
- A great security device when away from home

SKU NO. 503027

**INCANDESCENT DIMMER
 ROTARY ON/OFF**

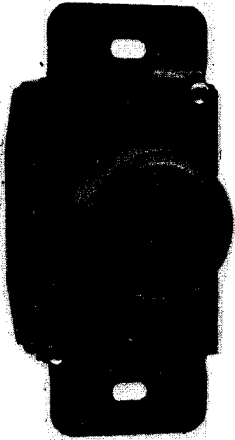

- UL Listed.
- Rotary on/off switch operation.
- 8 Amp semi-conductor.
- 100 Amp semi-conductor surge current rating.
- Advanced radio frequency interference protection circuitry.
- Reliable low-intensity operation.
- Silver alloy switch contacts.
- Fits all standard wall boxes and wall plates.
- Individually tested for full operation at factory.

Model No. 1100
 600 Watt 120 VAC 60 HZ
 Single Pole-Single Throw
 SKU NO 503005

**INCANDESCENT DIMMER
 ROTARY ON/OFF**



- UL Listed.
- 8 Amp semi-conductor.
- 100 Amp semi-conductor surge current rating.
- Advanced radio frequency interference protection circuitry.
- Reliable low-intensity operation.
- Full range dimming control.
- Silver alloy switch contacts.
- Engineered to look like a standard light switch.
- Fits all standard wall boxes and wall plates.

Model No. 1200 and 1300
 600 Watt 120 VAC 60 HZ
 SKU NO. 503006 Single Pole-Single Throw (1200)
 503009 Single Pole-Double Throw (1300)

**TOGGLE
 CONTROLLED**

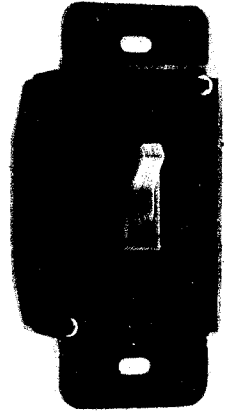

Model No. 8100 and 8300
 600 Watt 120 VAC 60 HZ
 SKU NO. 503018 Single Pole-Single Throw (8100) B
 503012 Single Pole-Double Throw (8300) I

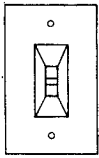

C-1 IVORY

**INCANDESCENT DIMMER
 TOGGLE CONTROLLED**

- UL Listed
- 25 Amp semi-conductor.
- 200 Amp semi-conductor surge current rating.
- Heavy-duty toroid for maximum radio frequency interference protection.
- Silver alloy switch contacts for long life on-off cycling.
- Large heatsink for cooler operation.
- Complete with cover plate.
- Break-away fins for multiple ganging and spacing accommodations.
- Fits single wallbox.

Model No. 8110,
 1000 Watt 120 VAC
 Single Pole-Single Throw
 SKU N. 503069

Model No. 8115
 1500 Watt 120 VAC
 Single Pole-Single Throw
 SKU NO. 503072

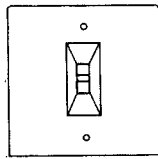

C-2 IVORY

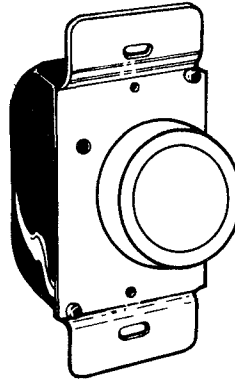

Model No. HMC5 EX
 5 AMP 120 VAC 60 HZ
 Externally Adjustable
 Low Voltage Setting

**MOTOR SPEED CONTROLS
 ROTARY ON/OFF**

- UL Listed.
- 8 Amp semi-conductor.
- 100 Amp semi-conductor surge current rating.
- Advanced radio frequency interference protection circuitry.
- Infinitely variable control.
- Low voltage protection.
- All solid state circuitry.
- Fits all standard wall boxes and wall plates.

SKU NO. 503051

7

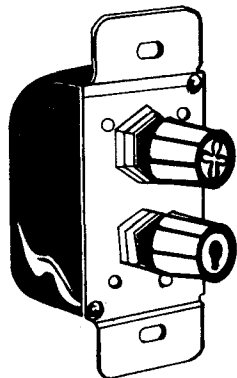

**Solid State Dual
 Fan/Light Control**

Model DMC 3
 Fan: 3 AMP (maximum)
 Light: 300 Watts (maximum)
 Incandescent only
 120 VAC 60 Hz
 (3 wires required for installation)

- **Saves Energy**
- **Infinitely variable control; adjusts fan speed and light independently**
- **Complete with knobs and wall-plate**

SKU NO. 503063

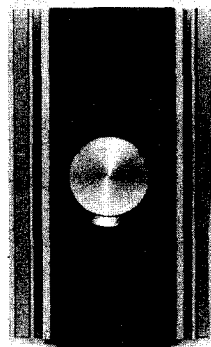

Model No. HMC8
 8 AMP 120 VAC 60 HZ
 Internally Adjustable
 Low Voltage Setting

**MOTOR SPEED CONTROLS
 ROTARY ON/OFF**

- UL Listed.
- Heavy-duty toroid for maximum radio frequency interference protection.
- Infinitely variable control.
- Low voltage protection.
- All solid state circuitry.
- Fits all standard wall boxes.
- Individually tested for full operation at factory.

SKU NO. 503054

CONVERTERS

503068	P4C	Electric Adpt Plug Set
503062	V10C	Electric 1000 Watt
503067	V16C	Electric 1600 Watt
503052	V16P	Electric 1000 Watt Plug Set
503071	V5C	Electric 50 Watt

Major Appliance Cords

UL Listed.

Woods Major Appliance cords for air conditioner, range, and dryer feature heavy duty vinyl insulation and right angle plugs.

SKU NO.	Cat No	Ga/ Cond	Wire Type	Cord Length	Cord Color	125V Rating
Air Conditioner						
500940	43	14/3	SPT-3	3'	beige	15A
500950	44	14/3	SPT-3	6'	beige	15A
500955	45	14/3	SPT-3	9'	beige	15A
500970	47*	14/3	SPT-3	15'	beige	15A



OUTDOOR — ROUND VINYL Extension Cords

UL Listed. Meets OSHA Specifications

Outdoor Cords are designed for most applications around the home or job site. All cords are manufactured with copper conductors, solid molded plugs for longer life, two layers of insulation, which won't mark floors or walls.

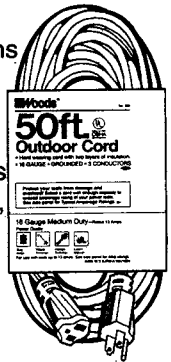

Household Appliance Cords

UL Listed.

Slotted miniature plug fits most electric coffee makers, frypans and other small kitchen appliances with 1/2" spacing between contacts

SKU NO.	Cat No	Ga/ Cond	Wire Type	Cord Length	Cord Color	125V Rating
501055	294	18/2	HPN	6'	black	10A

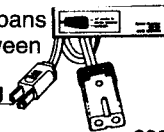

SKU NO.	Cat No	Ga/ Cond	Wire Type	Cord Length	Cord Color	125V Rating
500695	265	16/3	SJTW-A	8'	orange	13A
500700	266	16/3	SJTW-A	15'	orange	13A
500725	269	16/3	SJTW-A	100'	orange	10A
507345	393	16/3	SJTW-A	40'	green	13A
500730	625	14/3	SJTW-A	25'	orange	15A
500740	626	14/3	SJTW-A	50'	orange	15A
500745	627	14/3	SJTW-A	100'	orange	13A
507348	394	16/3	SJTW-A	80'	green	10A
500755	528	12/3	SJTW-A	25'	orange	15A
500760	529	12/3	SJTW-A	50'	orange	15A
500770	530	12/3	SJTW-A	100'	orange	15A

3-Outlet Power Blocks

UL Listed. Meets OSHA Specifications.

Power Blocks are made with solid molded three-outlet plugs.

SKU NO.	Cat No	Ga/ Cond	Wire Type	Cord Length	Cord Color	125V Rating
500820	825	14/3	SJTW-A	25'	orange	15A
500830	826	14/3	SJTW-A	50'	orange	15A
500835	827	14/3	SJTW-A	100'	orange	13A

Three conductor, extra heavy duty 600V insulated wire.

500845	824	12/3	STW-A	2'	orange	15A
501508	814	14/3	STW-A	3'	orange	10A



Polarized remote control cord.

584896	359	16/2	SPT-2	15'	brown	10A
--------	-----	------	-------	-----	-------	-----

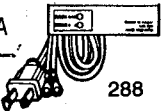

Cold Flex 3-Outlet Power Blocks-TPE

UL Listed. Meets OSHA Specifications.

SKU NO.	Cat No	Ga/ Cond	Wire Type	Cord Length	Cord Color	125V Rating
501505	676	12/3	SJEW-A	100'	blue	15A

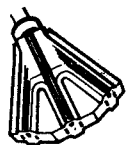

INDOOR UTILITY— FLAT VINYL Extension Cords

501295	831	16/3	SPT-2	25'	yellow	13A
501300	832	16/3	SPT-2	50'	yellow	13A
501310	833	16/3	SPT-2	100'	yellow	10A
501315	834	14/3	SPT-3	25'	yellow	15A
501325	835	14/3	SPT-3	50'	yellow	15A
501330	836	14/3	SPT-3	100'	yellow	13A
501340	837	12/3	SPT-3	25'	yellow	15A
501345	838	12/3	SPT-3	50'	yellow	15A
501355	839	12/3	SPT-3	100'	yellow	15A

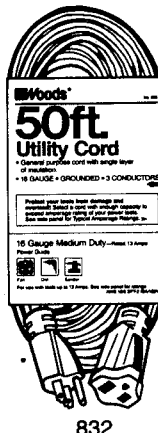

OUTDOOR COLD FLEX — TPE Extension Cords

UL Listed. Meets OSHA Specifications.

SKU NO.	Cat No	Ga/ Cond	Wire Type	Cord Length	Cord Color	125V Rating
501400	655	16/3	SJEW-A	15'	blue	13A
501405	656	16/3	SJEW-A	25'	blue	13A
501415	657	16/3	SJEW-A	50'	blue	13A
500784	658	16/3	SJEW-A	100'	blue	10A
500875	2734	14/6	SJEW-A	50'	yellow 15A	
501430	662	14/3	SJEW-A	25'	blue	15A
501435	663	14/3	SJEW-A	50'	blue	15A
501445	664	14/3	SJEW-A	100'	blue	13A
501450	668	12/3	SJEW-A	25'	blue	15A
501460	669	12/3	SJEW-A	50'	blue	15A
501465	670	12/3	SJEW-A	100'	blue	15A
500782	2805	10/3	SJEW-A	50'	yellow 15A	
500787	2806	10/3	SJEW-A	100'	yellow 15A	



7

POWER SUPPLY CORDS

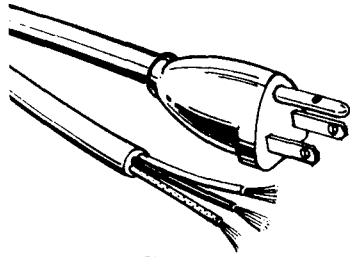

Heavy Duty

Gray

SKU No.	Product Number	Cord Size & Type	Length	Rating
3 CONDUCTOR				
501538	XB146060	16/3 SJT	6 Ft.	13A
501390	XB146090	16/3 SJT	9 Ft.	125V

Jacket removed 1 1/2" Conductors stripped 1/2".

RETRACTILE CORDS - POWER

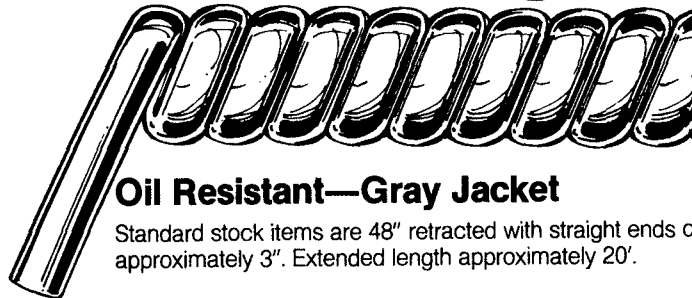

Oil Resistant—Gray Jacket

Standard stock items are 48" retracted with straight ends of approximately 3". Extended length approximately 20'.

Type ST 600 Volt—60°C

SKU No.	Product Number	Size AWG	O.D. Inch	Amps.
506569	RD424400	14/4	.60	15
506572	RD422300	12/3	.61	25
506578	RD422400	12/4	.64	20

CORD HOLDERS

SKU NO	MFG NO	CAPACITY
307553	CH150	150 FT
583047	CR100	100 FT

PORTABLE QUARTZ WORK LIGHTS 500 WATTS

SKU NO	MFG NO	FEATURE
790923	PQ25	LIGHT ONLY
825505	SQ500WL	WITH ADJUSTABLE POLE STAND

7

TROUBLE LIGHTS — ROUND VINYL

UL Listed. Meets OSHA Specifications for temporary lighting.

DUAL HOOK SYSTEM which permits hanging the trouble light by either its guard or handle. All 3-conductor lights are Metal grounded guard with switch and grounded outlet

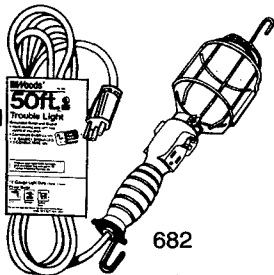

SKU NO.	Cat No	Ga/ Cond	Wire Type	Cord Length	Cord Color	Bulb Wattage Rating	125V Rating
500455	682	18/3	SJTW-A	50'	orange	100W	10A
500460	691	16/3	SJTW-A	25'	orange	100W	13A
500470	692	16/3	SJTW-A	50'	orange	100W	13A

Our catalog does not contain everything in our inventory. If there are products you do not find that are related to those in this catalog call 437-1205 so that we may assist you.

7

REEL LIGHTS — RETRACTABLE

UL Listed. Meets OSHA Specifications for general use.

All reels are made of epoxy finished steel and come complete with hard ware for wall or ceiling mounting. Cords are manufactured to the same strict standards as our other extension cords

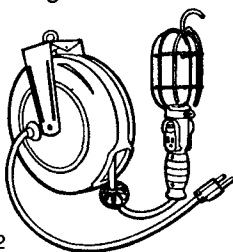

500505	211	16/3	SJT	30'	black	—	10A
--------	-----	------	-----	-----	-------	---	-----

Cord Reels

Power Block. Solid molded plug with three grounded outlets. Ceiling or wall mount.

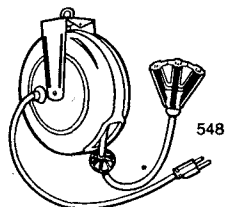

500530	548	16/3	SJTW-A	30'	orange	—	10A
--------	-----	------	--------	-----	--------	---	-----

FLUORESCENT TROUBLE LIGHT

UL Listed.

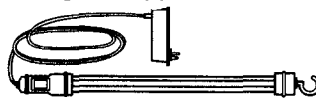

Woods®

Fluorescent Trouble Light is ruggedly built, with a shatter resistant housing. Each unit has an on/off switch, and adjustable hanger hooks.

SKU NO.	Cat No	Ga/ Cond	Wire Type	Cord Length	Cord Color	125V Rating
500500	221	18/2	SJT	25'	yellow	15W

FLOOD & CLAMP LAMPS

UL Listed.

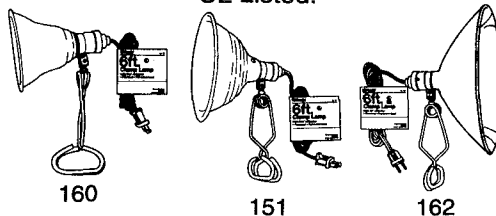

SKU NO.	Cat No	Ga/ Cond	Wire Type	Cord Length	Cord Color	Ref Dia	125V Rating
500565	160	18/2	SPT-2	6'	white	5-1/2"	60W
500575	151	18/2	SPT-2	6'	white	8-1/2"	150W
500580	162	18/2	SPT-2	6'	white	10"	150W

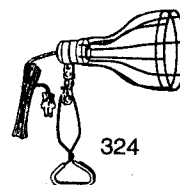

With bulb protector, sturdy, anodized wire construction. Porcelain socket.

500620	324	18/2	SPT-2	6'	white	—	150W
Porcelain socket clamp without switch							
500610	328	18/2	SPT-2	6'	white	—	150W
Cold Flex TPE cord stays flexible in cold environment.							
500590	149	18/2	SJEW-A	15'	black	8-1/2"	150W

BROODER & HEAT LAMP

Heat Lamps feature insulated porcelain sockets, heavy gauge 167 aluminum reflectors, hang-up hooks and bulb guards that snap on the reflector,

Same with a sturdy clamp with vinyl coated grips

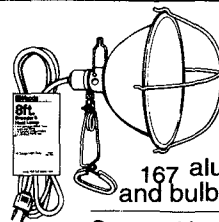

500625	167*	18/2	SJEW-A	8'	black	10-1/2"	250W
--------	------	------	--------	----	-------	---------	------

REPAIR PARTS



503113	309	Guard, metal, swing open					
500680	321	Reflector, 5-1/2", aluminum					
500685	320	Reflector, 8-1/2", aluminum					

SPECIALTY CORDS
Household Extension Cords (Cube Taps)

vacuum cleaners, lamps, irons, water coolers,
 UL Listed air conditioners replacement cords
 Woods Household Extension Cords are manufactured with
 three polarized outlets in a solid molded plug for use indoors.

SKU NO.	Cat No	Ga/ Cond	Wire Type	Cord Length	Cord Color	125V Rating
501193	600	16/2	SPT-2	6'	brown	13A
501165	601	16/2	SPT-2	9'	brown	13A
501175	602	16/2	SPT-2	12'	brown	13A
501180	603	16/2	SPT-2	15'	brown	13A
501192	600W	16/2	SPT-2	6'	white	13A
501190	601W	16/2	SPT-2	9'	white	13A
501195	602W	16/2	SPT-2	12'	white	13A
501205	603W	16/2	SPT-2	15'	white	13A



600

Power Supply Cords – Repair/Replacement

UL Listed.
 Appliance end slit 1-1/4", insulation stripped 3/8". Right angle male cap for garbage disposals and water coolers.

SKU NO.	Cat No	Ga/ Cond	Wire Type	Cord Length	Cord Color	125V Rating
501541	589	16/3	SJTW-A	8'	black	13A

Vinyl, for power tools or appliances.

Stay flexible in very cold environments, TPE cord, for powertools or appliances.

500895	951	16/3	SJEW-A	10'	black	13A
--------	-----	------	--------	-----	-------	-----

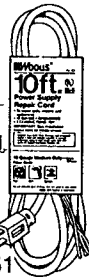

951

Major Appliance Cords

UL Listed.

Dryer

500935	976	10/3	SRDT	6'	gray	30A	974
--------	-----	------	------	----	------	-----	-----

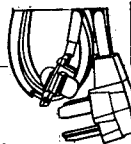

MULTIPLE OUTLETS
 UL Listed.

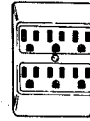

Taps

796

SKU NO.	Cat No	Cond	Type	Description	Color
500775	796	3	6-Outlet	Grounded	ivory
500785	596	3	6-Outlet	Grounded	brown

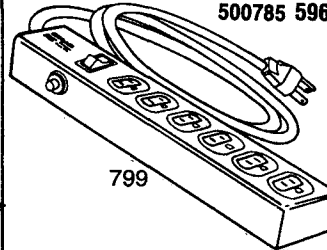

799

Strips

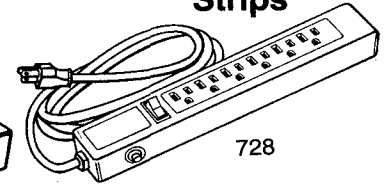

728

SKU NO.	Cat No	Cond	Type	Description	Wire Type
500815	799	3	6-Outlet	Metal w/circuit breaker and 4' cord	14/3 SJT ivory
500805	728	3	6-Outlet	Plastic w/circuit breaker and 4' cord	14/3 SJT ivory

SURGE SUPPRESSORS

UL Listed.

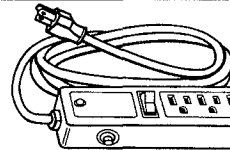

418

Strips

SKU NO.	Cat No	Protection Type	Type	Description	Clamping Voltage @ 500 Amps	Color
507023	417	Full	6-Outlet	Surge strip (Metal)	400V	ivory
507026	418	Full	6-Outlet	Surge strip	400V	ivory

Adapters

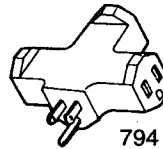

794

501375	794	3	3-Outlet
--------	-----	---	----------

Color

beige

7

3-Outlet Power Blocks Meets OSHA Specifications.
 Power Blocks are made with solid molded three-outlet plugs.

SKU NO.	Cat No	Ga/ Cond	Wire Type	Cord Length	Cord Color	125V Rating
500860	819	12/3	SJTW-A	50'	orange	15A
500865	820	12/3	SJTW-A	100'	orange	15A

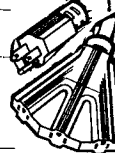

Three conductor, extra heavy duty 600V insulated wire.

500845	824	12/3	STW-A	2'	orange	15A
--------	-----	------	-------	----	--------	-----

PARTS



336

Cat No	Description
--------	-------------

Trouble Light Parts

501360	336	Handle, 3 cond. w/ switch & outlet
--------	-----	------------------------------------

Porcelain socket clamp without switch

500610	328	18/2	SPT-2	6'	white	150W
--------	-----	------	-------	----	-------	------

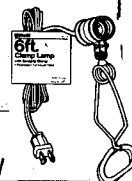

Specialty Items

Permanent Mount 25ft Extension Cord Single outlet extension cord adds 25ft of base cord.



502159	907	almond
--------	-----	--------

Spinfree™ Tangle-Free Adapter.

Put an end to twisted cords.



500112	910	almond
--------	-----	--------

SL WABER® MULTIPLE OUTLET STRIPS

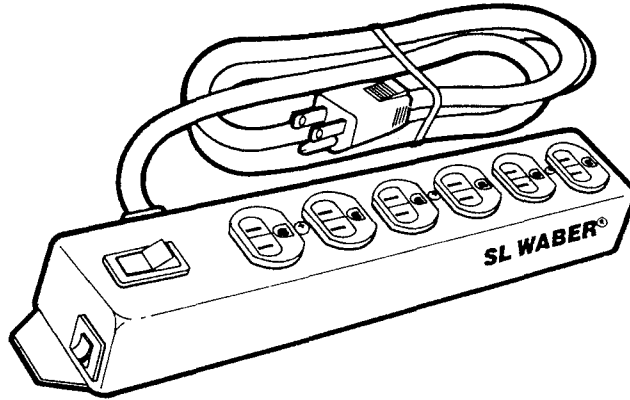

SKU	MODEL NUMBER	NUMBER OF OUTLETS	CORD LENGTH	CIRCUIT BREAKER	ON/OFF SWITCH
502724	UL605CB	3	6'	YES	YES
502769	603CB	4	6'	YES	NO
502721	UL603CB	4	6'	YES	NO
502742	UL32PCB	4	6'	YES	
502763	602	5	6'	YES	NO
502709	UL602CB	5	6'	YES	NO
502718	UL602CB	5	15'	YES	NO
502784	24CB	6	6'	YES	YES
502739	UL24CB	6	6'	YES	YES
502736	UL18CB	9	6'	YES	YES

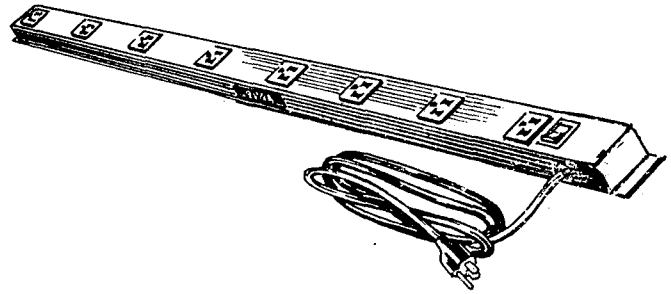

Trimline Series

SKU	MODEL	NUMBER OF OUTLETS	CORD LENGTH	CIRCUIT BREAKER	ON/OFF SWITCH
502757	UL7208	8	6'	YES	YES
502751	UL7408	8	6'	YES	YES
502748	UL7610	10	6'	YES	YES

Cordgard® Electrical Cord Ducting

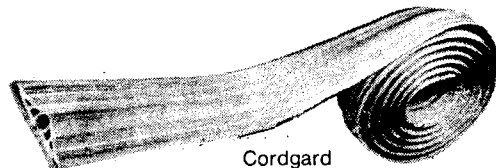

SKU NO.	MFG. NO.	COLOR	LENGTH
502796	G-6 BEX	BEIGE	6' x 3" W x 9/16" H
502793	G-6 BRX	BROWN	6' x 3" W x 9/16" H
502799	G-15 BEX	BEIGE	15' x 3" W x 9/16" H
502804	G-15 BRX	BROWN	15' x 3" W x 9/16" H
502802	G-50 BEX	BEIGE	50' x 3" W x 9/16" H

Sold by Foot

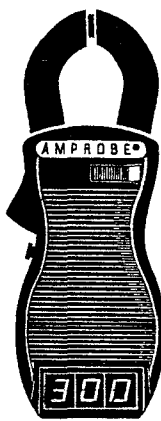

DIGITAL AC CLAMP-ON WITH LED DISPLAY

VOLTAGE RANGE AC 0-1-999
 CURRENT RANGE 0.1-3000
 OPERATING FREQUENCY 25-400 HZ.
 ± 2% RDG ± LSD

SKU NO. 512580
 MFG. NO. ACD-2
 CARRING CASE AE-2

3 1/2" DIGIT INDUSTRIAL MULTIMETER

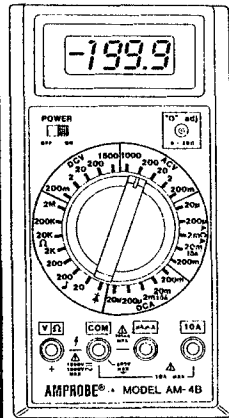

VOLTAGE RANGE
 0-1.999/19.99/199.9 VAC
 0-1.999/19.99/199.9 VDC

ACCURACY
 DC: ± 0.8% of reading ± 1 LSD
 AC AMPS ± 1.5% of reading ± 3LSD
 RESISTANCE ± 1% of reading ± 2LSD

SKU NO. 51257R
 MFG. NO. AM-4B

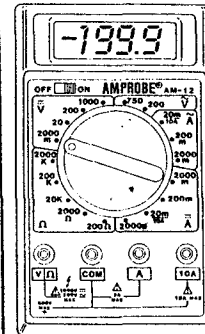

VOLTAGE RANGE
 0-1.999/19.99/199.9 VAC
 0-1.999/19.99/199.9 VDC
 ACCURACY
 DCV: ± 0.5% of RDG ± 2LSD
 AC AMPS ALL RANGES
 CURRENT RANGE
 0-1999uADC
 0-19.99/199.9/1999uADC
 0-10 AMPS AC/DC

SKU NO. 512582
 MFG. NO. AM12

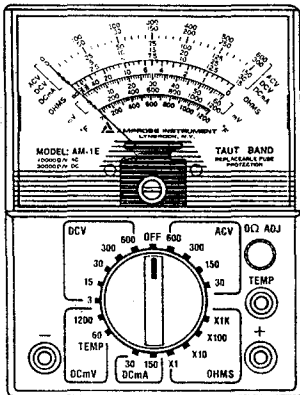

INDUSTRIAL ANALOG VOM'S
 WITH 4 OHMMETER RANGES
 INCLUDING SENSITIVE 5-0HM
 MIDSCALE. 2 MILLIVOLT RANGES.
 VOLTAGE: AC-30/150/300/600
 C 10,000 OHMS/V
 DC: 0-3/15/30/300/600
 (30,000 OHMS/V)
 ACCURACY: ± 3% of F.S.
 on DC; ± 4% of F.S.
 on AC.

SKU NO. 512565
 MFG. NO. AMIE

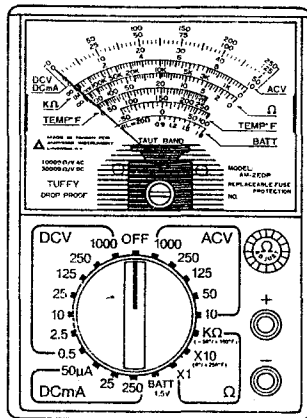

INDUSTRIAL ANALOG VOM'S
 HAS 33.3A SENSITIVITY, 20 OHM
 MIDSCALE OHMMETER, VOLTAGE:
 RANGE: AC: 0-10/50/125/250/1000
 (10,000 OHMS/V), DC: 0-0.5/2.5/10/25/
 125/250/1000 (30,000 OHMS/V)

SKU NO. 512565
 MFG. NO. AM-2EDP

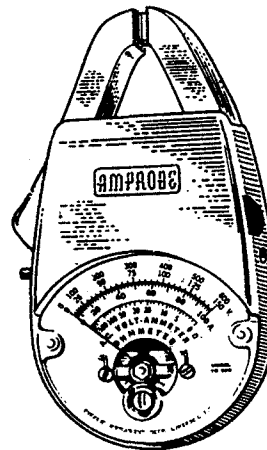

JUNIOR CLAMP-ON
 TAPERED JAWS, CONDUCTORS UP
 TO 1/2" RANGE SWITCH KEEPS
 JUNIOR ON HIGHEST RANGE
 UNTIL PRESSED
 AC-VOLTAGE 0-150/600 AC; CURRENT
 -100 RESISTANCE ACCURACY ± 3% of ARC
 OPERATING FREQUENCY 60 HZ.

SKU NO. 512550
 MFG. NO. Y0500

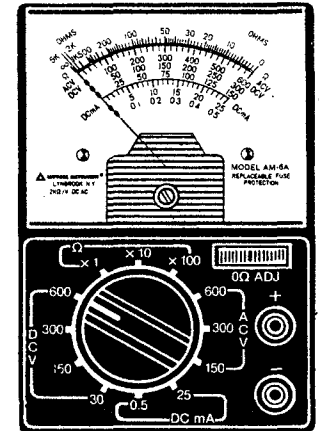

INDUSTRIAL ANALOG VOM'S
 FUSE PROTECTED MISAPPLICATION UP TO
 220 VOLTS, VOLTAGE: 0-150/300/600
 VAC (2,000 OHMS/V)/0-3/150/300/600
 VDC (2,000 OHMS/V), CURRENT 0.500 UA/
 25 MADC, ACCURACY: ± 3% F.S. DC; ± 4%
 F.S. AC; OHMS ± 3% of ARC.

SKU NO. 512570
 MFG. NO. AM6A

ROTARY SCALE

MODEL
RS-3
 VOLTS, AC
 0-150/300/600
 AMPS, AC
 0-6/15/40/100/300



SKU NO. 512540



**VOLTPROBE®
 VOLTAGE
 TESTER**

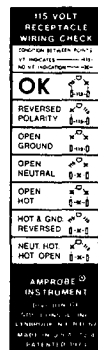

VOLTS, AC
 115/220/277/
 440/550

SKU NO. 512595
 MODEL NO. VT-100

TEST MASTER KIT

MULTIMETER
 contains extendo
 leads, energizer
 & case

SKU NO. 512545
 w/R53
 KIT

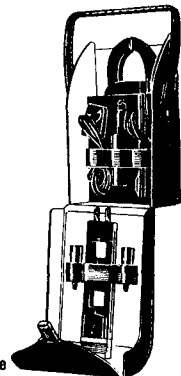

TM63
 A Case

7

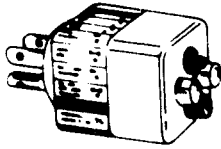

CT102 Receptacle Tester

- Checks correct wiring for 15 or 20 amp, 120 VAC single-phase 3-wire receptacles.
- High visibility colored lamps.
- Reliable electronic components, no mechanical failures.
- Easy-to-read chart explains light display.
- Compact size fits shirt pocket.
- Dimensions: 3" x 1 1/8" x 1 3/8".
- Made in U.S.A.

SKU NO. 502175

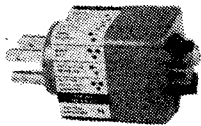

CT101 Receptacle/GFI* Tester Combined



Performs three tests with one installation!

- Tests conventional or GFI protected 120 VAC outlets for correct wiring.
- Tests GFI protected outlets to insure against trip at 2 mA.
- Tests GFI protection to insure trip mechanism function at 5 milliamp level (actual test level is 6.8 milliamp)
- High visibility lamps and easy-to-read attached chart enable convenient usage.
- Made in U.S.A. Patented. 3" x 1 3/8" x 1 3/8"

SKU NO. 502165

7

WE CARRY A COMPLETE LINE OF ALL TESTERS

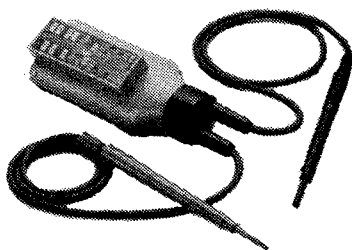

VT154 Audible Voltage/Continuity Tester-Solenoid Type

- Positive AC/DC voltage identification: 6 to 600 Volts 60/50 Hz.

SKU NO. 502245

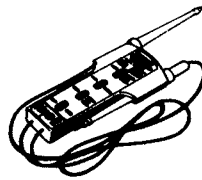

VT200 Voltage Tester-Neon Type

- Compact. Fits in tight spaces.
- High visibility voltage indicator: 120, 208 to 240, 277, 440 to 600 VAC; 120, 240, 400, 600 VDC.
- Positive or negative DC pole identified by neon lamps.
- Provision for quick prod storage in case.
- Case serves as prod holder for one-hand operation.
- Replaceable probe tips.
- Continuous duty rated through 480V.
- Dimensions: 4 9/16" x 2 1/16" x 7/8".
- Made in U.S.A.
- VT200LL Heavy duty leather case.

SKU NO. 502195

SKU NO. 502345 VT-200LL Leather Case

SKU NO. 502255 VT-200P Replacement Lead Assembly



ML800 Lock-Off™ Multiple Lockout

- Prevents accidental startup of equipment while repairs are in progress.
- Corrosive-resistant materials excellent for environments requiring frequent washdown, salt spray areas and outside applications.
- Accommodates up to six padlocks. All must be removed before startup.
- Dimensions: 3" diameter, 3/8" thick.

SKU NO. 505036



VT150 Voltage Tester-Solenoid Type



- Dual voltage indication: Solenoid vibration sensing and electronic neon visual indication.
- Positive AC/DC voltage identification: 120, 240, 480, 600 VAC 60/50 Hz; 120, 240, 600 VDC. • Replaceable leads.
- Positive or negative DC pole identified by neon lamp.

SKU NO. 502185

SKU NO. 502335 VT-150LL Leather Case

SKU NO. 505021 VT-150P Replacement Lead

SKU NO. 502245 VT-154 Tester Audible Voltage

ETCON.

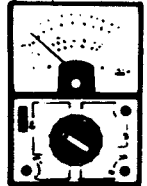

VOM910 Fused Mini-Multimeter

- Ranges: 10/50/250/1000 VDC
10/50/250/1000 VAC
1/100/250 mA, DC
200k ohms
- All ohms modes are Fuse Protected (AGC 1/10).
- Diode protected meter movement.
- Compact and lightweight.
- Shock and friction resistant meter movement.
- Wide angle meter deflection.
- Includes case, probes, battery, fuse and instruction manual.
- Dimensions: 3 1/2" x 2 1/4" x 1 1/4".

SKU NO. 502225

SKU NO. 502235 VOM910F Replace Fuse

VOM900 Fused Multimeter

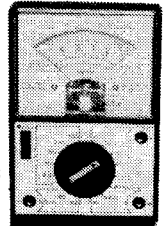

- Ranges:
25/5/2.5/10/50/250/1000 VDC
10/50/250/1000 VAC
.05/2.5/25/250 mA/10A DC, 10A AC
2k/20k/200k/2M ohms

SKU NO. 502235



KT500 Continuity Tester

- All plastic-insulated against accidental discharge.
- Protected 1 1/2" test probe. Built-in lamp.
- Rugged alligator clip. 36" test lead.
- Uses two AA penlight size batteries (not included).

SKU NO. 505033



RT300 Continuity Tester/Flashlight Combined

- Added convenience of a handy, durable flashlight.
- Uses two AA penlight size batteries (not included).
- Made of heavy brass, copper-nickel plated for superior electrical characteristics.
- Insulated clip prevents accidental shorting to case.
- Alligator clip has 36" lead with plug.
- Rugged, full-size pocket clip for convenient carrying.

SKU NO. 502205



**COMBINATION SCREWDRIVER,
 VOLTAGE PROBE AND
 CONTINUITY TESTER**

- Tests for continuity and AC voltage.
- LED indicator glows when voltage or continuity exists.
- Batteries included.
- Handy screwdriver tip

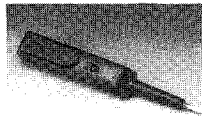

SKU NO.	CATALOG NUMBER	DESCRIPTION
507812	GCV 206	Voltage Probe/Continuity Tester

**TOOL AND STRIPPER/
 CRIMPING TOOL KIT**

- contains multi-use stripper/crimper with 100 assorted terminals.

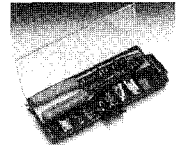

SKU NO.	CATALOG NUMBER	DESCRIPTION
474794	GK-15	Terminal and Crimping Tool Kit

**FIVE-FUNCTION, 12-RANGE
 MULTIMETER**

- Tests AC/DC voltage, DC current resistance and decibels.
- Includes two safety test leads, instruction manual and battery.
- Impact resistant shell.
- Convenient, pocket-size instrument.



SKU NO.	CATALOG NUMBER	DESCRIPTION
509642	GMT-12A	12-Range Multimeter w/ two test leads

ELECTRICAL TOOL BOX

For automotive, marine, electrical and hobby uses.

- offers and assortment of the most popular Gardner Bender wire connectors, terminals, cable ties, electrical tape and black wire.
- Items are neatly packed inside a versatile two-sided compartment case.

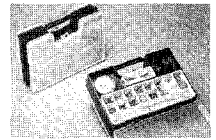

SKU NO.	CATALOG NUMBER	DESCRIPTION
509637	GK-50	Electrical Tool Box

**SURE WIRE™ BRANCH CIRCUIT
 ANALYZER**

Sure™ Wire prevents shock hazards and damage to electrical equipment by verifying the resistance in the branch circuit is of a low value to allow circuit breakers, fuses and GFCIs to operate as intended.

- Operates on live 120V circuits.
- Simple push-button operation tests receptacles connected to ground fault protected circuits for proper operation.
- Detects 6 common wiring conditions: normal, bad ground, open neutral, reversed hot/neutral, reversed hot/ground, open hot.

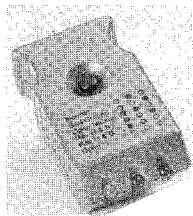

SKU NO.	CATALOG NUMBER	DESCRIPTION
507803	GRT-800	Branch Circuit Analyzer

WIRE STRIPPER

For solid or stranded wire

- Highly visible wire gauge wire gauge numbers are embossed and painted.
- Plier nose and looping hole aid in pulling and terminating.
- Power spring return and cushion grips for handling comfort. Air pocket cushion grips available on deluxe model.



SKU NO.	CATALOG NUMBER	DESCRIPTION
509638	GSD-55	Deluxe Stripper (#10 to #18 AWG solid or stranded)

**TEMP-STICK™ DIGITAL
 THERMOMETER**

- MEASURES BOTH °F AND °C, From -40°F to 300°F (-40°C to 150°C).
- Data hold feature.
- Rugged and water-resistant.
- 3-minute auto-off to conserve batteries.
- Removable protective cap.

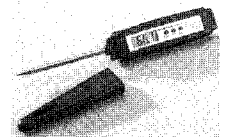

SKU NO.	CATALOG NUMBER	DESCRIPTION
507818	GTM-300	Digital Thermometer

CIRCUIT TRACKER™

Circuit Breaker Locator

- Located Circuits without turning off breakers
- No adjustment necessary
- Audible & visual indicators
- Impact resistant soft grip™ housing
- Exclusive probe design for improved sensitivity, even in noisy industrial applications.
- Uses 9 volt battery (not included)

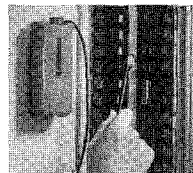

SKU NO.	CATALOG NUMBER	DESCRIPTION
507800	GET-1200	Circuit Breaker Locator

**CIRCUIT ALERT™ NON-
 CONTACT VOLTAGE TESTER**

- Tests from 50-600V AC.
- Visual (flashing) and audible (beeping) indicators signal presence of voltage.
- Built-in "safe test" feature to assure tester and batteries are operating properly.
- Batteries included.

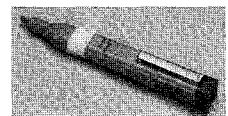

SKU NO.	CATALOG NUMBER	DESCRIPTION
507809	GVD-504A	Circuit Alert™ Non-contact Voltage Tester



VACO® ELECTRICAL TESTERS

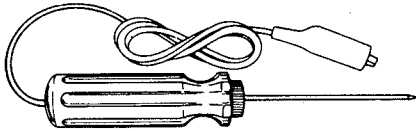

6/24V Tester & Probe

TK550 7-3/4

SKU NUMBER 502115 MFG NUMBER TK550

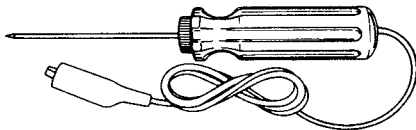

Continuity Tester

SKU NUMBER 502155 MFG NUMBER 70008 7-3/4



No. 70306.



No. 70307.



No. 70308.

Twin Lead Testers

No. 70306. 5-50V Alligator clips on ends. Pocket clip.

SKU NUMBER 502125 MFG NUMBER 70306

No. 70307. 110V-460V Combination of test lamps indicate voltage: 110V, 220V, 277V or 460V. Probes on lead ends. Pocket clip.

SKU NUMBER 502135 MFG NUMBER 70307

No. 70308. 90-250V Probes on lead ends. Pocket clip.

SKU NUMBER 502145 MFG NUMBER 70308

G Case



B Case (closed)



A CASE



AMPROBE CASES

SKU NO.	MFG. NO.	MODELS FOR
512805	G	RS Models
512810	K	JR Models
512815	MM	1a,2a,B,2BDP,2DP
512848	MM12	AM12
512835	MM44	AM44 & others
512820	MM6	AM-6
512825	AE2	ACD2/ACD4



AMPROBE INSTRUMENT®

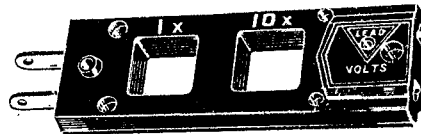

ENERGIZER
INCREASES CURRENT MEASURING SENSITIVITY 10 TIMES FOR CHECKING SMALL CURRENT LOADS

SKU NO. 512665 MFG. NO. A47L

VOLTAGE TESTERS

SKU NO.	MFG. NO.	RANGE
512585	VT100	115/220/440/550VAC AC/DC
512800	VT100B	115/220/440/550VAC AC/DC

FAST BLOW FUSE

SKU NO.	MFG. NO.	FOR MODEL
513220	3AG-312A	3/10AMP/3AG-312A
512961	6,3X252-12	AM12
512740	8AG-361	1AMP/8AG-361
512960	8AG-361.5	1AMP/8AG-361.5

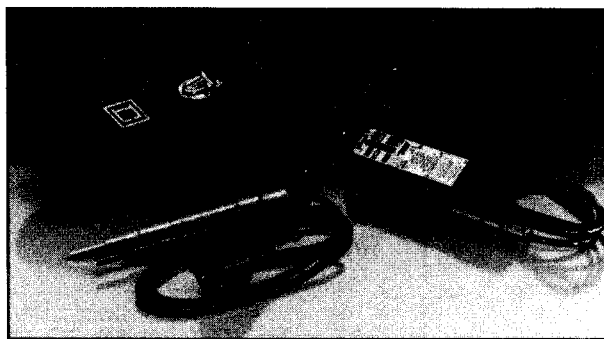

WIGGY®

Voltage Tester

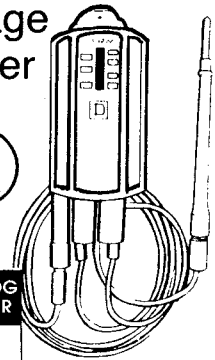

ITEM DESCRIPTION

CATALOG NUMBER

WIGGY® VOLTAGE TESTER

Standard Tester – Class 6610 Solenoid Type w/Polarity Indicator
120-240-480-600 50/60 Hz AC 120-240-600 DC

Carrying Case

Replacement Leads

VT-1

L-2

P-1

SKU No. 507034

ETCON

RL401 AC/DC Right-Light™ Tester

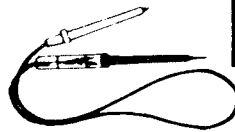

RL400 AC/DC Right-Light™ Tester

- Low voltage circuit tester.
- For circuits rated from 5 to 50 Volts.
- Long probes, 24" leads increase user span.
- High-visibility incandescent lamp.
- Compact size fits any shirt pocket.
- Dimensions: 5 1/16" long probes.
- Made in U.S.A.

SKU NO. 502265

RL403 AC/DC Right-Light™ Tester

- For circuits rated from 80 to 600 Volts.
- Compact design with shirt pocket clip.
- All plastic with insulated safety finger grips.
- High visibility neon lamp indicator.
- Dimensions: 6" long.
- Made in U.S.A.

SKU NO. 502295

Safe and convenient.

- For circuits rated from 80 to 600 Volts.
- High visibility neon lamp indicator.

SKU NO. 502275

RL402 AC/DC Right-Light™ Tester

- For circuits rated from 3 to 28 Volts AC/DC.
- Unique tri-colored LED with DC polarity test.
- Compact design with shirt pocket clip.
- All plastic with insulated safety grips.
- Dimensions: 6" long.
- Made in U.S.A.

SKU NO. 502285



PROBE PARTS ITEM

SKU NO.	MFG. NO.	ITEM
512640	HVPT	Tip for FV4
512735	MTC2	Alligator clip adapters
501234	MTL-2	Voltage leads
512725	MTL-1	Test leads
512726	MTL-12	Leads for AM12
512573	OHB-3R	OHM meter attach RS models
512655	OHB-4	OHM meter Testleads ACDC1000
512705	OHJR	OHM meter attach. jr models
512710	PT	Replacement tips VL11R leads
512540	RS3	Multimeter clipon clip AVBO
512545	TM63	Multimeter RSS kit
512555	TM70500	Multimeter Y0500 kit
512685	VL11R	Clitype lead RS models
512690	VL55R	Clitype lead, ALP,Y,YO,VT,VTOS
512695	VL750R	750V Multiplier lead
512675	VLK100R	Extendo lead set 1000A
512670	VLK411R	Extendo leadset 100,200,300A
512680	VLK455R	Extendo lead set ALP,Y,YO,YTO,JR
512715	VPT	Replace tips, VLK411R VLK100R
512720	VRC320	Allig clip adaptor for VPT



TV ACCESSORIES

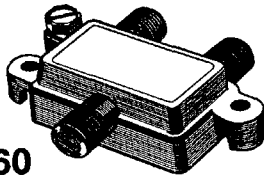

CV60
Two-Way Splitter
 75 ohm - allows two components to receive same signals

SKU NO 509660

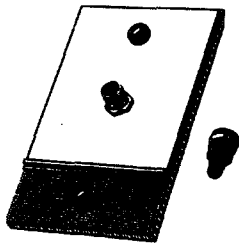

CV77
Coaxial Cable Wall Plate
SKU NO 509700

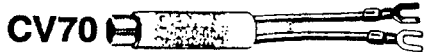

CV70
Matching Transformer
 Use to connect 75 ohm wire to a 300 ohm connection to TV.

SKU NO 509690

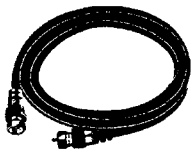

RG6C
6 ft. Coaxial Cable With "F" Connectors Both Ends
 To connect video components such as TV's and VCR's with high quality shielded cable to insure maximum signal with minimum interference

SKU NO. 509795

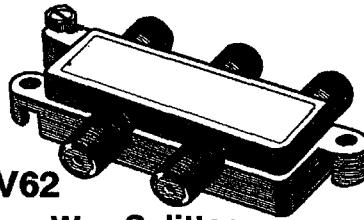

CV62
Four-Way Splitter
 Allows four components to receive signal

SKU NO 509665

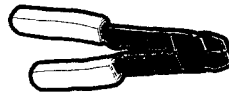

CV99 — COAXIAL CABLE CONNECTOR
 Crimping and stripping tool allows for easy installation of 75-ohm plugs onto coaxial cable. Tool gives sturdy, lasting connection of plug onto wire.

SKU NO. 509785

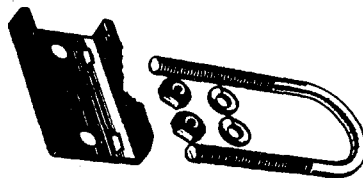

TV20
U-Bolt Assembly
SKU NO 509885

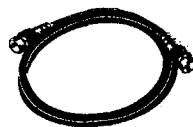

RG3C
3 ft. Coaxial Cable With "F" Connectors Both Ends
 To connect video components such as TV's and VCR's with high quality shielded cable to insure maximum signal with minimum interference

SKU NO. 509790

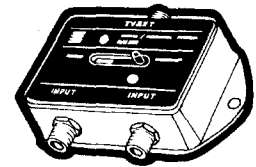

CV90 — CABLE TV/ANTENNA TWO-WAY SWITCH
75-OHM INPUTS: 75-OHM OUTPUT
 Allows choice between two signal sou with the flip of a switch. Connects 75-ohm coaxial cable inputs from Cable TV or VCR and from Antenna to 75-ohm coaxial cable output to TV set.

SKU NO 509750

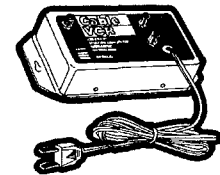

DA1400 — 10db SIGNAL AMPLIFIER — 4 WAY
 One input, four output amplifier with 10db boost restores signal loss due to multiple component hook-ups. Heavy-duty metal housing. For VHF/FM signal boost.

SKU NO 509650

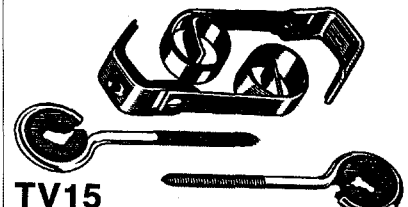

TV15
Mast Strap-On Stand-Offs
SKU NO 509875

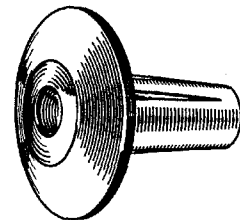

CV78
Feed-Thru Bushing
 For 75 ohm cable
SKU NO 509705

7



TV ACCESSORIES



CV64
VHF/UHF/FM Signal Separator

To separate VHF and UHF signals from a single 75 ohm coaxial cable source and connect to a TV or VCR having 300 ohm VHF and 300 ohm UHF inputs.

SKU NO 509670

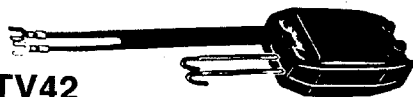

TV42
UHF/VHF Splitter
SKU NO 509895



CV67
VHF/UHF Signal Separator

To separate VHF and UHF signals from a single 300 ohm lead and connect to TV or VCR having 75 ohm VHF and 300 ohm UHF inputs.

SKU NO 509685



CV 65
VHF/UHF/FM BAND SEPARATOR

To separate VHF and UHF signals from a single 75 ohm lead and connect to a TV or VCR having 75 ohm VHF and 300 ohm UHF inputs.

SKU NO 509675

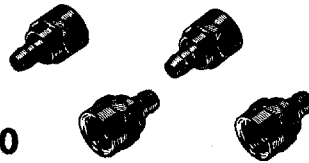

CV80
Coaxial Cable "F" Connectors

Allows coaxial cable to be connected to TV's, VCR's, etc.

SKU NO 509715

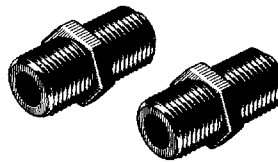

CV81
Coaxial Cable Double F

Connects two coaxial cables in line.

SKU NO 509720



CV 109
RG6U TWIST-ON COAX CABLE "F" CONNECTORS(2)

F connector for coaxial cable

SKU NO 509718



CV 71
OUTDOOR MATCHING TRANSFORMER

Transformer for the outdoors

SKU NO 509695



CV 76
TWIST-ON "F" CONNECTORS FOR RG59U COAXIAL CABLE(2)

SKU 589554



RG 12C
12 FT. COAXIAL CABLE WITH "F" CONNECTORS BOTH ENDS

To connect video components such as TV's and VCR's with high quality shielded cable to insure maximum signal with minimum interference.

SKU NO 509800



RG 50C
50 FT. COAXIAL CABLE WITH "F" CONNECTORS BOTH ENDS

To connect video components such as TV's and VCR's with high quality shielded cable to insure maximum signal with minimum interference.

SKU NO 509717

Woods®
CUSTOM CONNECTION™ COAX INSERT



SKU NO.	MFG NO.
501963	5807

CUSTOM CONNECTION™ OUTLET HOLDERS



5808



5806

SKU NO.	MFG NO.	TYPE
501955	5806	SINGLE
501961	5808	DOUBLE

TELEPHONE ACCESSORIES



6 WIRE MODULAR SURFACE JACK

6 wire jack for phones.



SKU NO 509940 TAN
SKU NO 509945 WHITE

6 WIRE DUPLEX JACK 6 X 6 ADAPTER

Converts one 6 wire jack to two 6 wire jacks.



SKU NO 509950 TAN
SKU NO 509955 WHITE

6 WIRE FLUSH MOUNTED/ MODULAR JACK

Flush mounted 6 wire jack for replacement and prewire use.

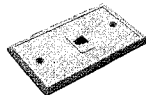

SKU NO 509942 TAN
SKU NO 509943 WHITE

6 WIRE FLUSH MOUNTED/ MODULAR DUPLEX JACK

Flush mounted 6 wire duplex modular wall jack for replacement and prewire use.



SKU NO 509947 TAN

6 WIRE STAINLESS STEEL WALL PLATE

Stainless steel wall plate.



SKU NO 509948

2 PIECE, 6 WIRE MODULAR WALL JACK

Flush mounted 6 wire jack with easy removable plate for replacement and prewire use

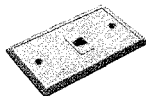

SKU NO 509949

6 WIRE MODULAR TRIPLEX 3 LINE JACK

Allows use of three phones on one modular jack.



SKU NO 509962

6 WIRE 25' MODULAR LINE CORD

Allows phone to be extended 25 ft. from wall.



SKU NO 509952 TAN
SKU NO 509953 WHITE

6 WIRE 25' MODULAR DUPLEX EXTENSION CORD

Allows two phones to be extended 25 ft. from wall.



SKU NO 509954

6 WIRE 12 FT MODULAR EXTENSION CORD

Allows phone to be extended 12 ft. from wall.



SKU NO 509956 TAN
SKU NO 509957 WHITE

6 WIRE 25 FT EXTENSION CORD MODULAR PLUG/JACK

Allows two phones to be extended 25 ft. from wall.



SKU NO 509958

6 WIRE 50 FT MODULAR PLUGS BOTH ENDS

SKU NO 509963



6 WIRE 100 FT MODULAR PLUGS BOTH ENDS

SKU NO 509959



7

TELEPHONE ACCESSORIES

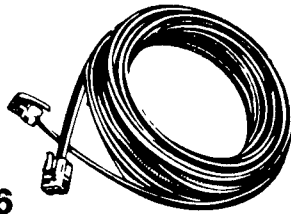

TA76
12 ft. Modular Line Cord

Allows phone to extend
12 ft. from wall.

SKU NO 509600

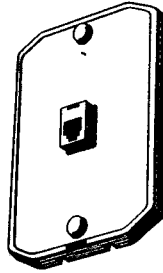

TA77
Wall Telephone Mount

With modular jack for
installing wall mount phones.

SKU NO 509605

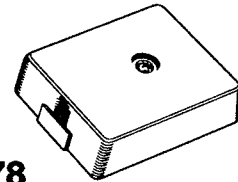

TA78
Modular Jack Cover

Converts old type phone
block to modular jack.

SKU NO 509610

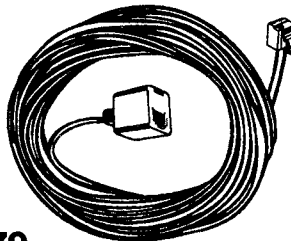

TA79
25' Extension Cord
Modular Plug/Modular Jack

SKU NO 509615

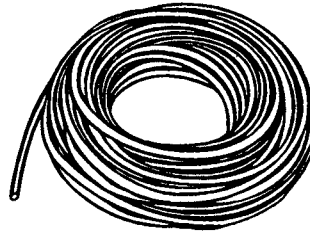

TA81
50 ft. Modular Line Cord

For extending existing telephone
wire or replacing old 4-wire wire.

SKU NO 509620

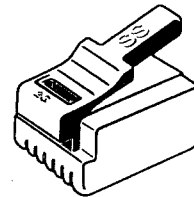

TA83
Modular Outlet Plugs

Allows for the termination of
flat phone wire with modular
plug between phone base units
and all standard modular
accessories. Not for use on coil
cords between base and
handset. **SKU NO 509625**

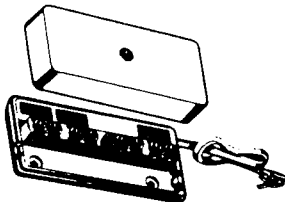

TA85
Wire Junction

Provides a junction point
for system wiring.

SKU NO 509635

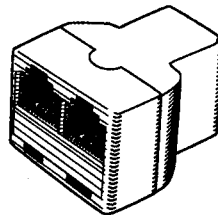

TA86
Three-Way Modular Jack

Allows three modular cords, having
modular plugs, to be connected
together, to extend total system
coverage. No cutting of wires
required.

SKU NO 501532

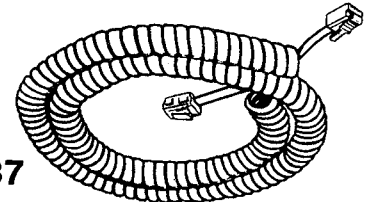

TA87
12 Foot Coil Cord
Modular Plugs Both Ends

SKU NO 502053 White
SKU NO 502059 Beige
SKU NO 509562 BLACK

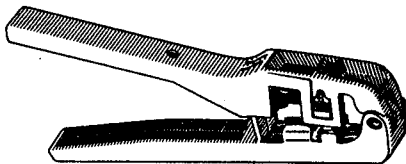

TA84
Modular Plug Crimping Tool
Use to connect standard
modular plugs and 4 wire
modular cable in new installa-
tions or replace existing.

SKU NO 509630

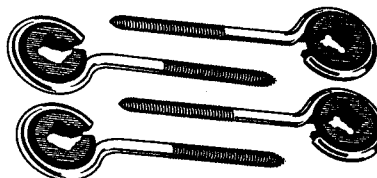

TV10
3 1/2" Wood Screw Stand-Offs

SKU NO 509855

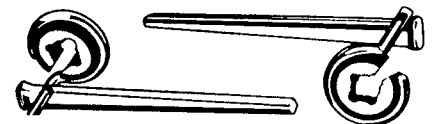

TV16
7.5 Wood Screws
Stand-Offs

SKU NO 509880



Woods®

**6 MODULAR BASE
 CORD CONNECTORS**

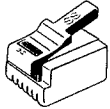

SKU NO.	MFG NO.	AMNT PER PKG
501358	1220	6

TELEPHONE ACCESSORIES

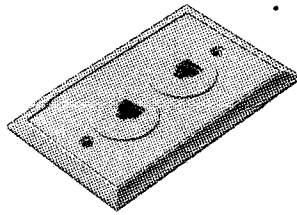

**TA 74
 WTA 74**

DUPLEX MODULAR WALL JACK

Flush mounted 4 wire dual jacks for replacement and prewire use.

**SKU NO 509581
 SKU NO 509582**

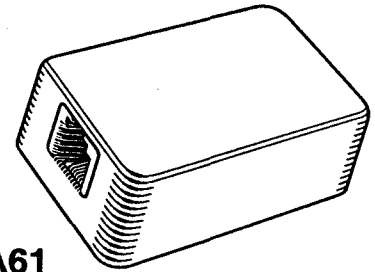

**TA61
 Modular Phone Jack**

Allows for convenient placement of modular jack. Mounts on any surface.

SKU NO 509550

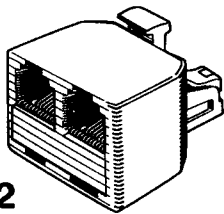

**TA62
 Modular Duplex Jack**

Allows use of two phones on one modular jack.

SKU NO 509555



**TA 65 BL
 TA65 BR
 TA65 BE
 TA65 WH**

25 ft. Modular Coil Cord
 Extends handset 25 ft. from phone

**SKU NO 509560 Beige
 SKU NO 509565 Brown
 SKU NO 509570 White
 SKU NO 509562 BLACK**

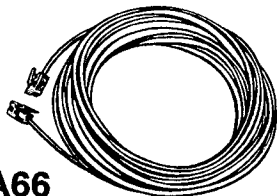

**TA66
 25 ft. Modular Line Cord**

Allows phone to be extended 25 ft. from wall.

SKU NO 509575

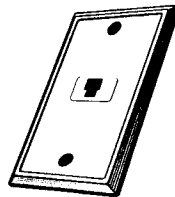

**WTA 67
 TA67**

Modular Wall Jack

Flush mounted 4 wire jack for replacement and prewire use.

**SKU NO 509580
 SKU NO 509583**

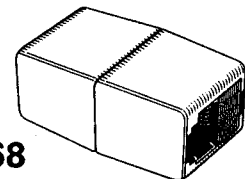

**TA68
 Modular Inline Coupler**
 Allows two modular line cords to be connected

SKU NO 509585

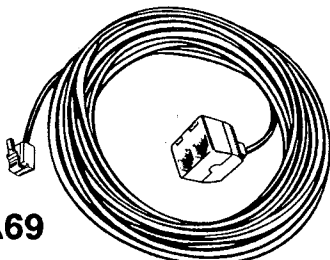

**TA69
 25 ft. Modular Extension Cord**
 Allows use of two phones on one jack.

SKU NO 509590

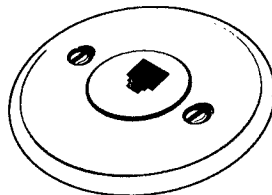

**TA71
 Round Wall Jack**
 Flush Mounted/Modular

SKU NO 509595

**Woods®
 CUSTOM CONNECTION™
 RJ-11 PHONE JACK INSERT**

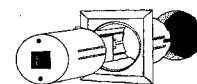

SKU NO.	MFG NO.
501957	5810

7

ACCESSORIES



BLACK

HEYCO NYLON SNAP-IN BUSHINGS C.S.A. APPROVED
(Finger pressure is all that's needed to assemble the bushing into its mounting hole)

SKU NO.	NUMBER	FITS HOLE	I.P.
505396	12630	5/16"	3/16"
505399	12633	3/8"	1/4"
505402	12636	1/16"	1/4"
505408	12639	1/2"	3/8"

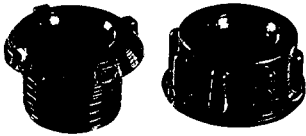

BAKELITE BUSHINGS

12601	12613
BLACK	BLACK
MALE 3/8-IP	FEMALE 3/8-IP
SKU NO. 505393	SKU NO. 505387



HEYCO STRAIN RELIEF BUSHINGS
12650 BLACK
1 PIECE NYLON FOR ALL SIZES LAMP CORD
(7/16" hole required)
SKU NO. 505411



BRASS CONNECTOR SNAPS ON BEAD CHAIN

16579
For No. 16564 bead chain (other end with 3/8" hole)
SKU NO. 505369



STANDARD CHAIN CONNECTORS
9820 BRASS
For No. 16564 bead chain

SKU NO. 507770



END BELLS
16576 BRASS
For beaded chain or pull cord

SKU NO. 505366

LOCKNUTS



SIXTEEN ASSORTED LOCKNUTS
70152 - STEEL
SKU NO. 505198

LOCK-UP KIT



LOCK-UP KIT
70638 - BRASS PLATED FINISH FOR CEILING GLASS TAPPED 1/8-IP
SKU NO. 505213

CHECK RINGS

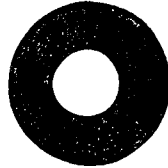

TWELVE ASSORTED CHECK RINGS
70154 - BRASS FINISH SLIPS 1/8-IP
SKU NO. 505201

CROSS BARS



21003
4" LONG
TAPPED 3/8-IP
SKU NO. 505147

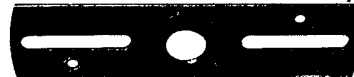

21005
4" LONG
TAPPED 1/4-IP
SKU NO. 505153



70112
4" OFFSET CROSSBAR 3/32" TAPPED HOLES 2 3/4" CENTER TO CENTER SLIPS 3/8-IP
SKU NO. 255240

KNOBS

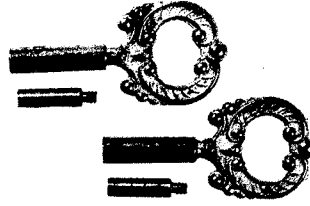

TWO SOCKET KEYS
70160 - BRASS FINISH 1/2" EXTENSIONS TAPPED 4/36-F x 4/36-M
SKU NO. 505204



TWO REPLACEMENT KNOBS
70161 1/2" EXTENSIONS TAPPED 4/36-F x 4/36-M
SKU NO. 505207



TWO 2" LAMP FINIALS
70130 - SOLID BRASS TAPPED 1/4-27.
SKU NO. 505216

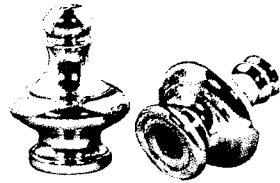

TWO KNOBS OR FINIALS
70131 - VACUUM BRASS TAPPED 1/4-27
SKU NO. 505219



SKU NO. SIX ASSORTED NIPPLES
505252 70151 1/4-IP
505192 70150 EIGHT ASSORTED NIPPLES 1/8-IP



LOOPS

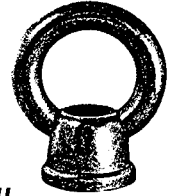

SKU NO. TWO FEMALE LOOPS
505168 70255 - BRASS FINISH
TWO FEMALE LOOPS
505171 70256 - ANTIQUE BRASS

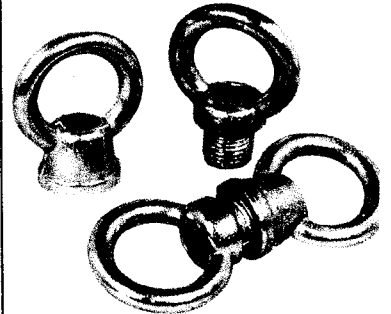

SKU NO. TWO MALE & TWO FEMALE LOOPS
505222 70250 - BRASS FINISH
TWO MALE & TWO FEMALE LOOPS
505231 70251 - ANTIQUE BRASS

DECORATIVE STEEL CHAINS



SKU NO. BRASS PLATED FINISH
505108 70070 ANTIQUE BRASS FINISH
505111 70071 FLAT BLACK FINISH
505114 70072 WHITE FINISH
505117 70670

7



**ALL-THREAD
PIPE**

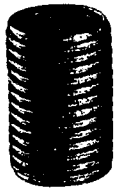

STEEL NIPPLES
ZINC PLATED

SKU NO.	STEEL NIPPLES ZINC PLATED	SIZE
505288	13406	3/4"
505291	13408	1"
505294	13412	1 1/2"
505297	13416	2"



SKU NO.	STEEL NIPPLES ZINC PLATED	SIZE
505258	13204	1/2"
505261	13206	3/4"
505264	13208	1"
505267	13212	1 1/2"
505273	13216	2"
505276	13224	3"
505279	13232	4"
505282	13248	6"



ALL-THREAD
FLOOR LAMP SIZE
STEEL PIPE
13638 1/4-IP x 36"

SKU NO. 505308

CROSSBARS

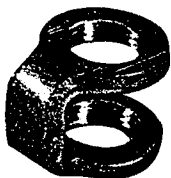

STEEL HICKEY

SKU NO.	STEEL HICKEY	SIZE
505378	21105	1/8-F x 1/4-F
505381	21107	1/8-F x 3/8-F
505384	21111	1/4-F x 3/8-F

1" HEIGHT

SCREWS



3/32 HOLDER
SCREWS
12511 1/2"
ANTIQUÉ BRASS

SKU NO. 505174



TURNED THUMB
SCREW
11613 SOLID BRASS
3/32 THREAD
1/2" SHANK

SKU NO. 505177

CAPS



HEXAGON
CAP NUT
10003 BRASS

SKU NO. 505159



SMALL KNURLED
BATTERY NUT
11700 BRASS

SKU NO. 505162



BRACKET CAP
10027 BRASS
3/8-F

SKU NO. 505429

COUPLINGS



COUPLING
10509 BRASS
TAPPED 1/8-IP

SKU NO. 505354



PLAIN COUPLING
10512 BRASS
3/16" LONG
TAPPED 3/8-IP

SKU NO. 505357

**BALLS &
B**



SOLID BRASS
DIAMETER 3/8"
10306 BRASS
TAPPED 3/32"

SKU NO. 505261



REDUCING BUSHING
10426 BRASS
3/8-M x 3/32-F

SKU NO. 505327



REDUCING BUSHING
10430 BRASS
3/8-M x 1/4-F

SKU NO. 505342



REDUCING BUSHING
10429 BRASS
3/8-M x 3/8-F

SKU NO. 505339



REDUCING BUSHING
10427 BRASS
3/8-M x 1/4-27F

SKU NO. 505333



REDUCING BUSHING
10428 BRASS
1/4-M x 3/8-F

SKU NO. 505336



STUD BUSHING
10438 BRASS
3/8-F x 1/8-F

SKU NO. 505348

LOCKNUTS



HEXAGON
11744 BRASS
DIAMETER 1/2"
TAPPED 1/8-IP

SKU NO. 505312



HEXAGON
11762 SPECIAL
HEAVY BRASS
DIAMETER 1/2"
TAPPED 1/8-IP

SKU NO. 505309



12060 STEEL
DIAMETER 1 1/16"
TAPPED 1/4-IP

SKU NO. 505321



12038
HEAVY STEEL
TAPPED 1/8-IP
3/16" THICK

SKU NO. 505318

**SOCKETS &
ACCESSORIES**

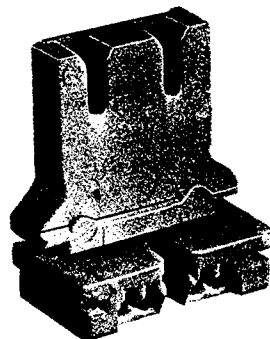

MEDIUM BI-PIN
FLOATING ACTION FOR
U-SHAPE LAMPS

22457
LOW PROFILE SIZE
20 GAUGE
660W, 600V

SKU NO. 505203

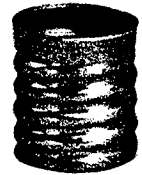

22401
Reduces French to
candelabra size
SKU NO. 505237

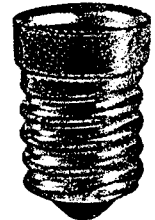

22402
BRASS SHELL
Reduces German
or Italian to
candelabra size
SKU NO. 505244



22403
Reduces intermediate
to candelabra size
SKU NO. 505243

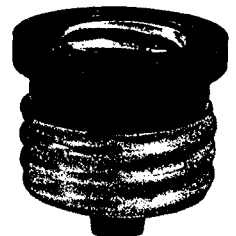

22404
Reduces medium to
intermediate size
SKU NO. 505238



KNOB
22540
PHENOLIC
TAPPED 4/36
SKU NO. 505246



BRASS KEY
EXTENSION
11040 1/2"
REGULAR THREAD
4/36 F x 4/36 M
(Size does not
include male thread)
SKU NO. 505249



CANOPY KITS

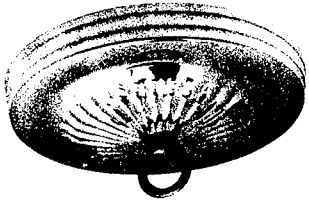

SKU NO. CANOPY
505129 70056 - WHITE FINISH

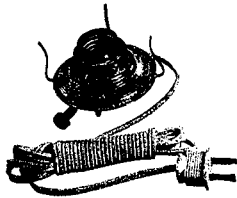

ELECTRIFIED
 NO. 2 BURNER
70020
 (For 3" fitter
 glass chimney)

SKU NO.
505234



TWO PLASTIC HOOKS
70788 - CLEAR
 SKU NO. 505123



FIXTURE SOCKETS

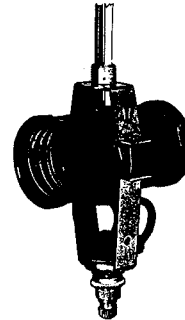

22252
 TURN KNOB, 3-WAY
 SWITCH
 HEIGHT 4 1/2"
 Threads on one end

SKU NO.
507835



PLASTIC SWIVEL HOOK
70799 - CLEAR
 SWIVELS 360°

SKU NO. 505126

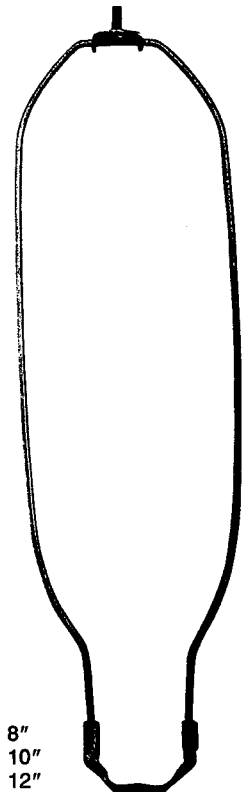

SKU NO.	MFG NO.
505183	70220 - 8"
505186	70222 - 10"
505189	70224 - 12"

**Ceiling Outlet
 Blankup Canopies**

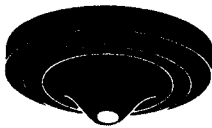

Standard
 1.875" deep—5" dia.
 With Kit* (K5)

Kit
 1/8" x 2" Plated Nipple
 1/8" nut and matching
 canopy and knob

SKU NUMBER	MFG NUMBER
505420	40418

WHITE SEMI-GLOSS	MFG NUMBER
	40418

7

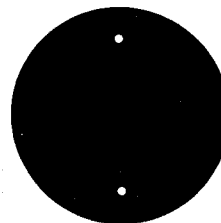

Flat
 .25" deep—5" dia.
 2 8-32 x 3/4 screws
 Screw Holes 3—1/2" cc
 (Fits 4" Round Box)

SKU NUMBER	MFG NUMBER
505420	40430

IVORY SEMI-GLOSS	MFG NUMBER
	40430

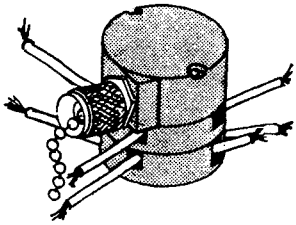

FAN SWITCH
#1692
 Three Speed
 Contains contacts for up to 8 wires.
 Used on many foreign made fans.

SKU NO. 555117

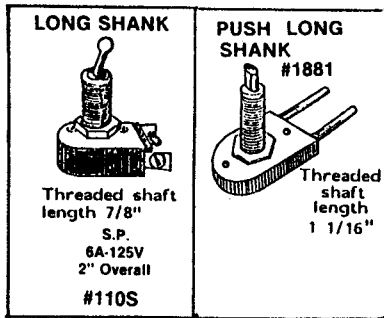

SKU NO. 555111

SKU NO. 555114

POWER TOOL SWITCH

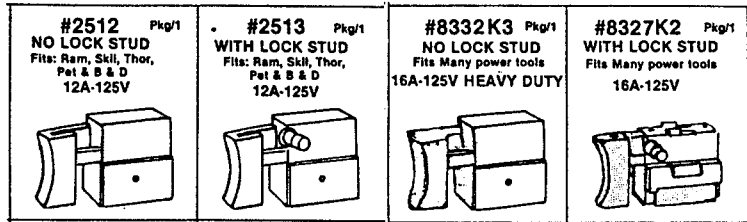

SKU NO. 502457

SKU NO. 502463

SKU NO. 502439

SKU NO. 502451

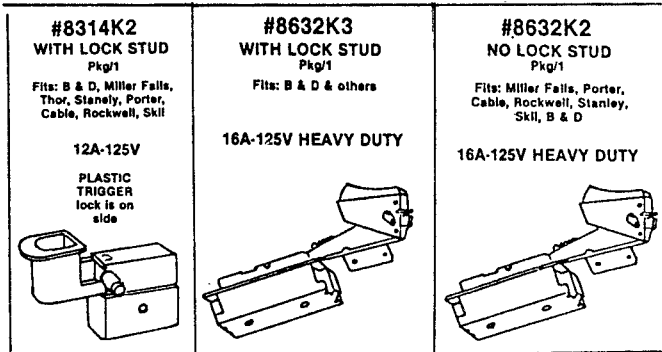

SKU NO. 502499

SKU NO. 502511

SKU NO. 502493

ORIGINAL CARBON BRUSH

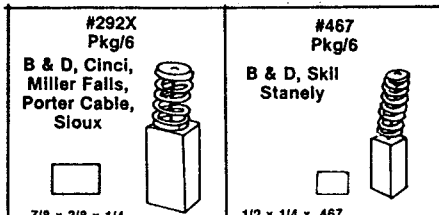

SKU NO. 502568

SKU NO. 502571

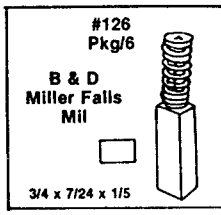

SKU NO. 502547

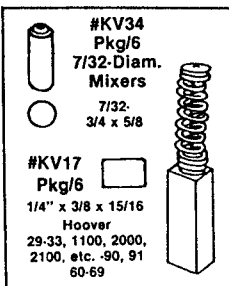

SKU NO. 502517 KV34
 SKU NO. 502529 KV17

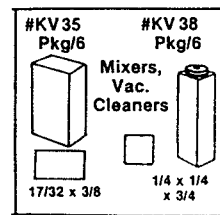

SKU NO. 502532 KV35
 SKU NO. 502538 KV38

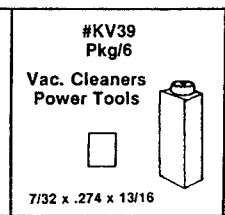

SKU NO. 502541

SKU NO. 502541

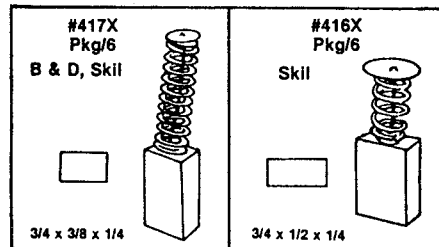

SKU NO. 502589

SKU NO. 502592

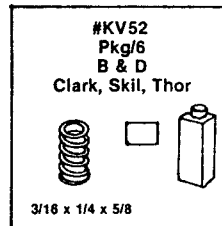

SKU NO. 502553

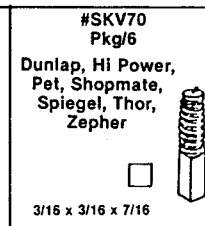

SKU NO. 502556

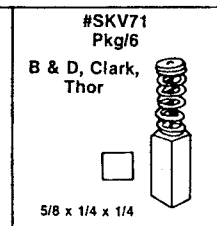

SKU NO. 502559

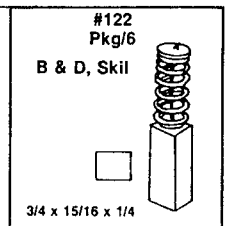

SKU NO. 502562

BEEES WAX

This product is used to lubricate such items as saws, sliding doors, screws, etc.

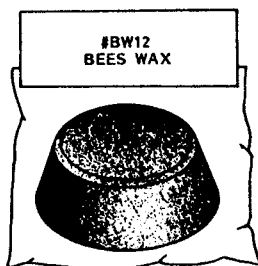

SKU NO. 805647

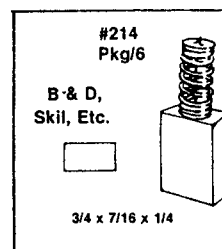

SKU NO. 502574

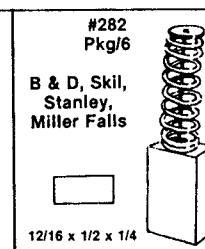

SKU NO. 502577

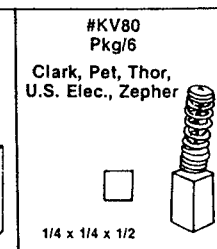

SKU NO. 502583

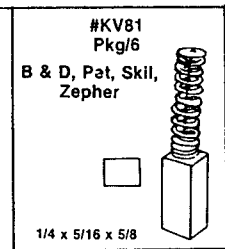

SKU NO. 502586

