

**Incandescent Lamps**

SKU NO.	Watts	Bulb	Base	Product Number	Volts	Description	Approximate	
							Life Hours	Initial Lumens
501732	3	S-6	CAND. ▶	3S6/5	120	CLEAR	3000	12
501746	6	S-6	CAND. ▶	6S6	12	CLEAR	1500	54
501748	6	S-6	CAND. ▶	6S6	24	CLEAR	1500	54
500093	6	S-6	CAND. ▶	6S6	30	TRAIN, CLEAR	1500	50
501734	6	S-6	CAND. ▶	6S6	120	CLEAR	1500	40
501736	6	S-6	CAND. ▶	6S6/R	115-125	RED	1500	
501738	6	S-6	CAND. ▶	6S6/W	120	WHITE	1500	34
500087	6	S-6	D.C. BAY	6S6DC	24	CLEAR	1500	54
501742	6	S-6	D.C. BAY	6S6DC	120	CLEAR	1500	40
501750	6	T4 1/2	CAND. ▶	6T4 1/2/1	115-125	INDICATOR, CLEAR	1500	40
501752	7	C-7	CAND. ▶	7C7	115-125	CLEAR	3000	45
501754	7	C-7	CAND. ▶	7C7/W	115-125	NIGHT LIGHT WHITE	3000	35
501756	7 1/2	S-11	MED. ▶	7 1/2S	120	CLEAR	1400	50
501758	7 1/2	S-11	MED. ▶	7 1/2SCW	120	WHITE	1400	39
501760	7 1/2	S-11	MED. ▶	7 1/2S/B 24 PK.	115-125	BLUE	1400	
501762	7 1/2	S-11	MED. ▶	7 1/2S/G 24 PK.	115-125	GREEN	1400	
501764	7 1/2	S-11	MED. ▶	7 1/2S/O 24 PK.	115-125	ORANGE	1400	
501766	7 1/2	S-11	MED. ▶	7 1/2S/R 24 PK.	115-125	RED	1400	
501772	10	C-7	D.C. BAY	10C7DC	115-125	CLEAR	(3)	56
501774	10	S-11	INTER.	10S11N	130	CLEAR	1500	80
501770	10	S-6	CAND. ▶	10S6/10	230	CLEAR	1500	69
501776	10	S-11	INTER.	10S11N	120	CLEAR	1500	80
501768	10	S-6	D.C. BAY	10S6/10DC	230	CLEAR	1500	66
501784	15	A-15	MED. ▶	15A15	120	INSIDE FROSTED	2500	126
501789	15	A-15	MED. ▶	15A15	130	INSIDE FROSTED	2500	126
501786	15	A-15	MED. ▶†	15AWL 12/2	120	LONG LIFE, SOFT WHITE	3000	114
502093	15	A-15	MED. ▶	15A15/CL	120	CLEAR	2500	126
501788	15	A-15	MED. ▶	15A15/CL	130	CLEAR	2500	126
501792	15	T-6	CAND. ▶	15T6	115-125	SWITCHBOARD, CLEAR	2000	114
501808	15	B-10	CAND. ▶	15BC	120	CLEAR	1500	136
501816	15	F-10	CAND. ▶	15FC/AV	120	AURADESCENT	1500	
501798	15	T-7	D.C. BAY"	15T7DC/IF	115-125	APPLIANCE, FROSTED	(4)	113
501800	15	T-7	D.C. BAY	15T7DC	115-125	APPLIANCE, CLEAR	(4)	115
501794	15	T-7	CAND. ▶	15T7C	115-125	APPLIANCE, CLEAR	(4)	115
501796	15	T-7	INTER. ▶	15T7N	115-125	APPLIANCE, CLEAR	(4)	115
501802	15	T-10	MED. ▶	BC-15T10 12/1	115-125	AQUARIUM, CLEAR	2500	115
501820	20	T6 1/2	INTER.	20T6 1/2/IF	120	EXIT SIGN, FROSTED	(3)	90
501822	20	T6 1/2	D.C. BAY	20T6 1/2 DC/IF	120	EXIT SIGN, FROSTED	(3)	90
501824	25	A-19	MED. ▶•	25A	120	INSIDE FROSTED	2500	232
501828	25	A-19	MED. ▶	25A/CL	120	CLEAR	2500	232
501832	25	A-19	MED. ▶	25A/B	115-125	BLUE	2500	
501834	25	A-19	MED. ▶	25A/G	115-125	GREEN	2500	
501836	25	A-19	MED. ▶	25A/O	115-125	ORANGE	2500	
501838	25	A-19	MED. ▶	25A/R	115-125	RED	2500	

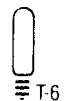
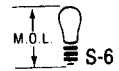

**7**

**Incandescent Lamps**

SKU NO.	Watts	Bulb	Base	Product Number	Volts	Description	Approximate	
							Life Hours	Initial Lumens
501840	25	A-19	MED.X	25A/R2	115-125	ROSE	2500	
501842	25	A-19	MED.	25A/Y	115-125	YELLOW	2500	
501830	25	A-19	MED.	25A/RS	120	ROUGH SERVICE, I.F.	1000	235
501896	25	F-15	MED.	25FM/W	120	WHITE	1500	179
501900	25	F-15	MED.	25FM/AU	120	AURADESCENT	1500	
501860	25	T6 1/2	D.C. BAY	25T6 1/2DC/F	120	FROSTED	1000	240
501856	25	T6 1/2	INTER. ▶	25T6 1/2/IF	115-125	FROSTED	1000	250
501854	25	T6 1/2	INTER. ▶	25T6 1/2	115-125	CLEAR	1000	250
501858	25	T-10	D.C. BAY	25T6 1/2DC	115-125	CLEAR	1000	250
501862	25	T-8	D.C. BAY	25T8DC	115-125	CLEAR	(4)	235
501864	25	T-8	CAND. ▶	25T8C	115-125	CLEAR	(4)	235
501866	25	T-8	INTER ▶	25T8N	115-125	CLEAR	(4)	235
501868	25	T-8	D.C. BAY	25T8DC/F	120	FROSTED	(63)	193
501878	25	T-10	MED. ▶	25T10/IF	120	FROSTED	1000	260
501870	25	T-10	MED. ▶	25T10	120	CLEAR	1000	260
501872	25	R-14	INTER	25	120	REFLECTOR FROST	1500	190
501826	25	T-19	MED. ▶	25T/SW	120	SOFT WHITE	2500	235
501844	25	A-19	MED.	25A	12	FROSTED	1000	378
501846	25	A-19	MED.	25A	230	FROSTED	1000	220
501906	30	R-20	MED. ▶	30R20	115-125	REFLECTOR, LT, LF.	2000	210
501910	30	T-8	END CAPS	L30	115-125	LUMILINE II, CLEAR	1500	245
501908	30	T-19	MED. ▶	30/100/SW	120	SOLFWHITE THREE -WAY (8)	1200	310 945 1255
501950	40	A-15	MED	40A15	120	CLEAR	1500	435
501951	40	A-15	MED. ▶	40A15	115-125	HOME APPLIANCE	1000	455
501916	40	A-19	MED. ▶	40A	120	FROSTED	1500	480
501922	40	A-19	MED. ▶	40A/TF	115-125	FROSTED SILKONE COATED	1500	
501920	40	A-19	MED. ▶	40A/CL	120	CLEAR	1500	480
501928	40	A-21	MED.	40A/B	115-125	BLUE	1000	
501932	40	A-21	MED.	40A/O	115-125	ORANGE	1000	
501934	40	A-21	MED.	40A/R	115-125	RED	1000	
501936	40	A-21	MED.	40A/Y	115-125	YELLOW	1000	
501988	40	F-15	MED.	40FM/W	120	PEARL (WHITE)	1500	390
501990	40	F-15	MED.	40FM/AU	120	AURADESCEAT	1500	
501954	40	G-16 1/2	CAND.	40GC/W	120	PEARL (WHITE)	1500	245
501964	40	S-11	INTER ▶	40S11N/IF	120	FROSTED	500	
501940	40	T-6 1/2	INTER ▶	40T6 1/2/2IF	115-125	FROSTED	1000	440
501938	40	T-6 1/2	INTER ▶	40T6 1/2/2	115-125	REFRIGERATOR CLEAR	1000	440
501944	40	T-8	MED. ▶	40T8/IF	115-125	FROSTED	1000	410
501942	40	T-8	MED. ▶	40T8	115-125	CLEAR	1000	410
501998	40	T-8	ENDCAPS	L40	115-125	LUMILINE II CLEAR (7)	1500	370
501948	40	T-10	MED. ▶	40T10/IF	120	FROSTED	1000	440
501946	40	T-10	MED. ▶	40T10	120	CLEAR	1000	440
501918	40	T-19	MED. ▶	40T/SW	120	SOFT WHITE	1000	490
501999	50	A-19	MED. ▶	50A/RS	120	ROUGH SERVICE IF	1000	465



A-19



F-15



T-6 1/2



T-8



T-10



A-15



R-14



G-16 1/2



S-11



T-19

**Incandescent Lamps**

SKU NO.	Watts	Bulb	Base	Product Number	Volts	Description	Approximate	
							Life Hours	Initial Lumens
502002	50	A-19	MED. ►	50A/RS/TF	115-125	ROUGH SERVICE FROST	1000	
502004	50	R-20	MED. ►	50R20	115-125	REFLECTOR, LT. IF. (82)	2000	420
502006	50	R-20	MED. ►	50R20/PL	120	REFLECTOR, PLANTS	2000	
502008	50	A-21	MED. ►	50A21	120	INSIDE FROST (53)	1000	875
502012	50	T-19	MED. ►	50/150T/SW	120	SOFT WHITE 3-WAY	1200	610 1510 2120
502014	50	A-21	MED. ►	50/150/DPK	120	DAWN PINK 3-WAY	1500	580 1640 2220
502016	50	A-21	MED.	50/250-1 12PK	120	SOFT-WHITE 3-WAY	1500 1200 1200	580 3660 4240
502024	52	A-19	MED.	60A/52WMP/99	120	WATT—MISER	2500	700
502018	60	A-19	MED. ►	60A	120	INSIDE FROSTED	1000	890
502022	60	A-19	MED. ►	60A/CL	120	CLEAR	1000	890
502026	60	A-19	MED. ►	60A/Y	115-125	BUG-A-WAY YELLOW	1000	
502030	60	A-19	MED. ►	60A/PL	120	PLANT LIGHT	1000	
502032	60	A-19	MED. ►	60A19/B	115-125	BLUE	1000	
502034	60	A-19	MED. ►	60A19/G	115-125	GREEN	1000	
502036	60	A-19	MED. ►	60A19/O	115-125	ORANGE	1000	
502038	60	A-19	MED. ►	60A19/R	115-125	RED	1000	
502040	60	A-19	MED. ►	60A19/R2	115-125	ROSE	1000	
502042	60	A-19	MED. ►	60A19/Y	115-125	YELLOW	1000	
502046	60	T-10	MED.	60T10/64IF	115-125	FROSTED	1000	745
502044	60	T-10	MED.	60T10/64	115-125	CLEAR	1000	745
502020	60	T-19	MED. ►	60T/SW 12/4	120	SOFT WHITE	1000	860
502028	60	T-19	MED. ►X	60T/PK 12/2	115-125	BEAUTY TONE PINK	1000	
502068	65	PAR-38	MED. SKIR	75PAR/FL/65WWM	120	WATT-MISER-FLOOD	2000	675
502090	75	A-19	MED. ►	75A	125	INSIDE FROSTED	750	1220
502094	75	A-19	MED. ►	75A/CL	120	CLEAR	750	1220
502100	75	A-21	MED.	75A/RS	120	I.F. ROUGH SERVICE (95)	1000	750
502102	75	A-21	MED.	75A/RSCVG	120	INSIDE FROST	1000	740
506546	65	PAR-38	MED. SKT.	65PAR/FL	115-125	PAR FLOOD(29)	2000	750
506536	65	PAR-38	MED. SKT.	65PAR/SP	115-125	PAR SPOT(29)	2000	750
506539	65	R-30	MED. ►	65PAR/FLSS	120	REFLECTOR FLOOD	2000	830
506542	65	R-30	MED. ►	65BR30/SP20	120	REFLECTOR SPOT	2000	830
502124	75	R-30	MED. ►	75R30/AGRO 6/1	120	AGRO-LITE PLANT LIGHT(19)	2000	
502112	75	R-30	MED. ►	75R30/A 8/1	115-125	AMBER(19)	2000	
502114	75	R-30	MED. ►	75R30/B 8/1	115-125	BLUE(19)	2000	
502116	75	R-30	MED. ►X	75R30/G 8/1	115-125	GREEN(19)	2000	
502118	75	R-30	MED. ►	75R30/PK 8/1	115-125	PINK(19)	2000	
502120	75	R-30	MED. ►	75R30/R 8/1	115-125	RED(19)	2000	

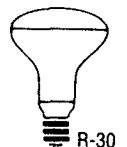
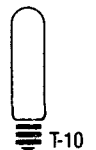
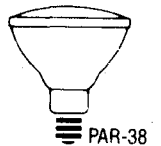
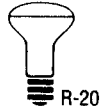
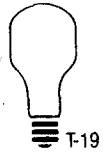

**Incandescent Lamps**

SKU NO.	Watts	Bulb	Base	Product Number	Volts	Description	Approximate	
							Life Hours	Initial Lumens
502122	75	R-30	MED. ▶	75R30/Y 8/1	115-125	YELLOW(19)	2000	
502092	75	T-19	MED. ▶X	75T/SW 12/4	120	SOFT WHITE	750	1180
502126	75	G-40	MED.	75G40/W	120	PEARL (WHITE)	2500	910
502128	100	A-19	MED. ▶	100A 12/4	120	INSIDE FROSTED	750	1750
502132	100	A-19	MED. ▶	100A/CL 12/2	120	CLEAR	750	1750
502136	100	A-21	MED. ▶	100A/RS/VS	120	ROUGH & VIB. SERV., I.F.	1000	1230
502138	100	A-21	MED. ▶	100A/RS/TF	115-125	ROUGH SVC, FROST SILICONE COATED	1000	
502146	110	A-21	MED.	100A	250	INSIDE FROST	750	
502148	10	A-21	MED.	100A	277	INSIDE FROST (32)	750	
502144	100	A-23	MED. ▶	100A23	120-130	INSIDE FROSTED	750	1650
502152	100	PAR-38	MED. SKT.	100PAR/A 6/1	115-125	PAR AMBER(29)	2000	
502154	100	PAR-38	MED. SKT.	100PAR/B 6/1	115-125	PAR BLUE(29)	2000	
502156	100	PAR-38	MED. SKT.	100PAR/G 6/1	115-125	PAR GREEN(29)	2000	
502158	100	PAR-38	MED. SKT.	100PAR/PK 6/1	115-125	PAR PINK(29)	2000	
502160	100	PAR-38	MED. SKT.	100PAR/R 6/1	115-125	PAR RED(29)	2000	
502162	100	PAR-38	MED. SKT.	100PAR/Y 6/1	115-125	PAR YELLOW(29)	2000	
502168	300	PS-25	3CT. MOG. ▶	100/300/W 12/1	120	SOFT WHITE THREE-WAY(8)	1200	1350 3350 4700
506521	85	R-40	MED. ▶	85BR/FL	120	FLOOD(19)	2000	1160
506523	85	R-40	MED. ▶	85BR/SP	120	SPOT(19)	2000	1160
502130	100	T-19	MED. ▶	100T/SW 12/4	120	SOFT WHITE	750	1710
502142	100	T-19	MED. ▶	100T/YL 12/2	115-125	BUG-A-WAY YELLOW, LONGER LIFE	1350	
502170	150	A-21	MED. ▶	150A	120	INSIDE FROSTED	750	2850
502172	150	A-21	MED.	150A/W	120	SOFT WHITE	750	2780
502206	150	A-21	MED. ▶	150A	130	INSIDE FROSTED	750	2850
502176	150	A-21	MED. ▶	150A/99	120	EXTENDED SERVICE, I.F.	2500	2350
502174	150	A-21	MED. ▶	150A/CL 12/1	120	CLEAR	750	2850
506526	120	PAR-38	MED. SKT.	120PAR/FL27	120	PAR FLOOD(29)(82)	2000	1730
506529	120	PAR-38	MED. SKT.	120PAR/SP27	120	PAR SPOTLIGHT (29)(82)	2000	1730
502180	150	PS-25	MED. ▶	150/RS/TF	115-125	ROUGH SVC, FROST SILICONE COATED	1000	
502209	150	PS-25	MED.	150/IF	130	INSIDE FROST	750	2680
502513	150	PS-25	MED. (BB)	150/99	120	I.F.-EXTENDED SERVICE	2500	2300
506532	120	R-40	MED. ▶	120BR/FL60	120	REFLECTOR FLOOD(9)(19)	2000	1900
506549	120	R-40	MED. ▶	120BR/SP60	120	REFLECTOR SPOT(9)(19)	2000	1900
502192	150	R-40	MED.	150R/A	120	REFLECTOR-AMBER	2000	
502194	150	R-40	MED. ▶	150R/B	115-125	BLUE(9)(19)	2000	
502196	150	R-40	MED. ▶	150R/G	115-125	GREEN(9)(19)	2000	
502198	150	R-40	MED. ▶	150R/PK	115-125	PINK(9)(19)	2000	

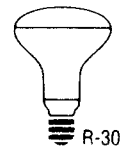

R-30



T-19



A-21

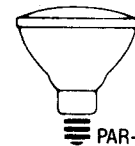

PAR-38



A-23



PS-25



PS-30

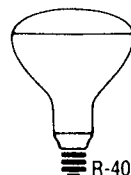

R-40

7

**Incandescent Lamps**

SKU NO.	Watts	Bulb	Base	Product Number	Volts	Description	Approximate	
							Life Hours	Initial Lumens
502200	150	R-40	MED. ►	150R/R	115-125	RED(9)(19)	2000	
502202	150	R-40	MED. ►	150R/Y	115-125	YELLOW(9)(19)	2000	
502204	150	R-40	MED. ►	150R/AGRO 6/1	120	AGRO-LITE PLANT LIGHT(9)(19)	2000	
502212	200	A-21	MED.	200A/W-1	120	SOFT WHITE (78)	750	3910
502221	200	A-23	MED. ►	200A	120	INSIDE FROSTED	750	3900
502214	200	A-23	MED. ►	200A/CL 12/1	120	CLEAR	750	3900
502216	200	PS-30	MED. ►	200/IF	120	INSIDE FROSTED	750	3710
502218	200	PS-30	MOG. "	200PS30/12	120	CLEAR	750	3700
502220	200	PS-30	MED. ►	200PS30/23	120	ROUGH SERVICE, I.F.	1000	3500
502208	200	PS-30	MED.	200	120	CLEAR	750	3710
502226	200	PS-30	MED.	200	250	CLEAR	1000	2980
502224	200	PS-30	MED. ►	200/IF	250	INSIDE FROST	1000	2980
502230	250	R-40	MED. ►	250R40/HR 12/1	115-125	HEAT RAY, RED BOWL(41)(82)	(27)	
502228	250	R-40	MED. ►	250R40/1	115-125	REFLECTOR INFRARED,	(27)	
502232	300	PS-25	MED. ►	300M	120	CLEAR	750	6300
502238	300	PS-25	MED. ►	300M/99IF	120	EXTENDED SERVICE, I.F.	2500	5060
502246	300	PS-25	MED. ►	300M/99IF	125-130	EXTENDED SERVICE, I.F.	2500	5060
502236	300	PS-25	MED. ►	300M/99	120	EXTENDED SERVICE, CLEAR	2500	5060
502240	300	PS-30	MED. ►	300M/PS30	130	CLEAR	750	6100
502248	300	PS-35	MOGUL	300	120	CLEAR	1000	5820
502254	300	PS-35	MOG.	300/RS	120	ROUGH SERVICE, CLEAR	1000	5250
502250	300	PS-35	MOG. ►	300/IF	120	INSIDE FROSTED	1000	5700
502252	300	PS-35	MOG. "	300/99	120	EXTENDED SERVICE, CLEAR	2500	5200
502256	300	R-40	MED. ►	300R/FL	120	REFLECTOR FLOOD (9)(19)(31)(37)	2000	3600
502258	300	R-40	MED. ► "	300R/SP	120	REFLECTOR SPOT (9)(19)(31)(37)	2000	3600
502260	375	G-30	MED. SKT. "	375G30	115-125	INFRARED, INDUS.(11)(31)	(27)	
502262	375	R-40	MED. SKT.	375R40/1	115-125	REFLECTOR INFRARED, IND. L.T.I.F (11)(31)	(27)	
502264	375	R-40 HRG SKIR	MED. SKIR	375R40/10	115	REFLECTOR INFRARD, IND. RED BOWL (36, 46, 56)	5000 (6)	
502318	500	G-30	MED.	500G30/1	115-125	INFRARED, INDUS.(11)(31)	(27)	
502266	500	PS-35	MOG (BB)	500	120	CLEAR	1000	10850
502268	500	PS-35	MOG.	500/IF	120	INSIDE FROSTED	1000	10750
502270	750	PS-52	MOG. (BB)	750	120	CLEAR (4, 92)	1000	17040
502272	750	PS-52	MOG. "	750/IF	120	INSIDE FROSTED	1000	16700

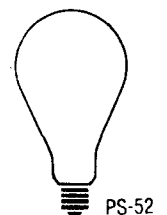
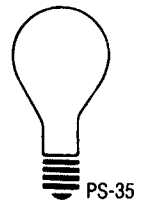
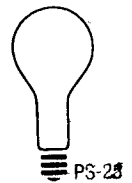
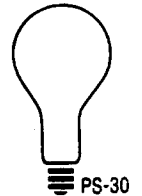
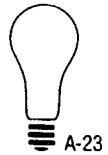
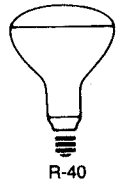

**Incandescent Lamps**

SKU NO.	Watts	Bulb	Base	Product Number	Volts	Description	Approximate	
							Life Hours	Initial Lumens
502274	1000	PS-52	MOG. (1313)	1000	120	CLEAR (4, 92)	1000	23740
502276	1000	PS-52	MOG."	1000/IF	120	INSIDE FROSTED	1000	23100

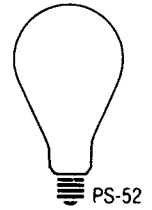

**High Intensity Lamps**

502316	32CP	RP-11	S.C.BAY	BC-1133 12/2	6	CLEAR	200	
--------	------	-------	---------	--------------	---	-------	-----	--



**Decorative Lamps**

506524	25	F-15	MED.▶	BC-25F15/W 6/2	120	FLAME, WHITE(12)	1500	
501812	15	F-10	CAND.	15F10C	120	FLAME, CLEAR(12)	1500	
501814	15	F-10	CAND.	15F10C/A	120	FLAME, AMBER(12)	1500	
501880	25	B10 1/2	CAND.	25B10 1/2	120	BLUNT TIP, CLEAR(12)	1500	
501892	25	BA-9	CAND.	25BA9C/F	120	BENT TIP, FROST(12)	1500	
501888	25	BA9 1/2	MED.	25BA9 1/2F	120	BENT TIP, FROST(12)	1500	
501902	25	F-10	CAND.	25F10C	120	FLAME, CLEAR(8)	1500	
501894	25	F-15	MED.	25F15/W	120	FLAME, WHITE(12)	1500	
501898	25	F-15	MED.	25F15/A	120	FLAME, AMBER(12)	1500	
501972	40	B10 1/2	CAND.	40B10 1/2	120	BLUNT TIP, CLEAR(12)	1500	
501976	40	B10 1/2	CAND.	40B10 1/2/W	120	BLUNT TIP, WHITE(12)	1500	
501982	40	BA-9	CAND.	40BA9C	120	BENT TIP, CLEAR(12)	1500	
501984	40	BA-9	CAND.	40BA9C/F	120	BENT TIP, FROST	1500	
501978	40	B9 1/2	MED.	40BA9 1/2	120	BENT TIP, CLEAR(8)	1500	
501980	40	B9 1/2	MED.	40BA9 1/2F	120	BENT TIP, FROST(8)	1500	
501986	40	F-15	MED.	40F15	120	FLAME, CLEAR	1500	
501952	40	G16 1/2	CAND.	40G16 1/2C	120	GLOBE, CLEAR	1500	
502050	60	B10 1/2	CAND.	60B10 1/2	120	BLUNT TIP, CLEAR	1500	
502086	60	BA-9	CAND.	60BA9C	120	BENT TIP, CLEAR	1500	
502088	60	BA-9	CAND.	60BA9C/F	120	BENT TIP, FROST	1500	
502056	60	BA9 1/2	MED.	60BA9 1/2	120	BENT TIP, CLEAR(8)	1500	
502058	60	BA9 1/2	MED.	60BA9 1/2F	120	BENT TIP, FROST(8)	1500	
501890	25	BA-9	CAND.†	25BA9C 12/8	120	BENT TIP, CLEAR(12)	1500	
501886	25	BA-9	CAND.†	25BA9 1/2 12/8	120	BENT TIP, CLEAR(12)	1500	
501874	25	G16 1/2	CAND.†	25G16 1/2C 12/8	120	GLOBE, CLEAR(12)	1500	
501876	25	G16 1/2	CAND.†	25G16 1/2 C/W	120	GLOBE, WHITE(12)	1500	

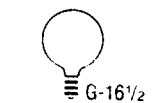
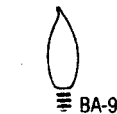
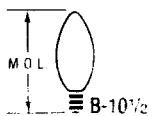

**Decorative Lamps**

SKU NO.	Watts	Bulb	Base	Product Number	Volts	Description	Approximate	
							Life Hours	Initial Lumens
501848	25	G-25	MED. ▶	25G25 12/1	120	GLOBE, CLEAR	1500	
501850	25	G-25	MED. ▶	25G25/W 12/1	120	GLOBE, WHITE	1500	
501956	40	G-25	MED. ▶	40G25 12/1	120	GLOBE, CLEAR	1500	
501958	40	G-25	MED. ▶	40G25/W 12/1	120	GLOBE, WHITE	1500	
502080	40	G-30	MED.	40G30/W	120	GLOBE, WHITE	4000	
501960	40	G-40	MED. ▶	40G40/4MW	120	GLOBE, WHITE	4000	
502048	60	G-40	MED. ▶	60G40/4MW	120	GLOBE, WHITE	4000	
502278	250	T-4	MIMI-CAN	250Q/CL	130	CLEAR(68)	2000	4800
502280	300	T-3	R.S.C.	300T3Q/CL EHM	120	CLEAR(10)	2000	6000
502282	400	T-3	R.S.C. \$\$\$	400T3Q/CL	120	CLEAR(10) ECON-O-WATT	2000	9200
502284	500	T-3	R.S.C.	500T3Q/CL FCL	120	CLEAR(10)	2000	10,500
502292	500	T-4	MINI-CAN	500Q/CL EVR	120	CLEAR(68)	2000	9800
502294	1000	T-3	R.S.C.	1000T3Q/CL	240	CLEAR(10)	2000	21000
502290	1500	T-3	R.S.C.	1500T3Q/CL	220	CLEAR(10)	2000	33000
502286	1500	T-3	R.S.C.	1500T3Q/CL	240	CLEAR(10)	2000	33000
502288	1500	T-3	R.S.C.	1500T3Q/CL	277	CLEAR(10)	2000	33000

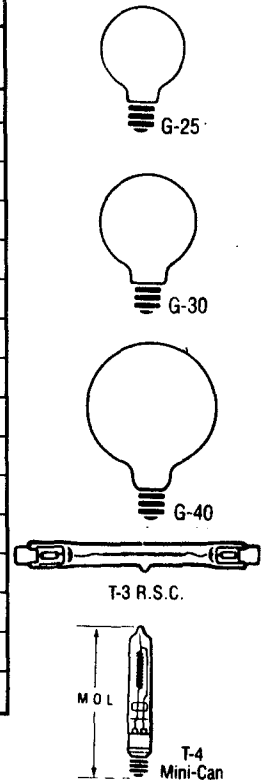

**High Intensity Discharge Lamps**

SKU NO.	Watts	Bulb	Base	Product Number	ANSI Code	Description	Life Hours	Approximate Lumens	
								Initial	Mean
503561	50	ED-17	Med. ■	C50S68/M	S68LP-50	★ G(360)(373)(376)	24000 +	4000	3600
503567	70	ED-17	Med. ■	C70S62/M	S62LG-70	★ G(360)(373)(376)	24000 +	6300	5670
503573	100	ED-17	Med. ■	C100S54/M	S54SG-100	★ G(360)(373)(376)	24000 +	9500	8550
503578	150	ED-17	Med. ■	C150S55/M	S55RN-150	★ G(360)(373)(376)	24000 +	16000	14400
503583	250	ED-18	Mog. ■	C250S50	S50VA-250	★ G,S(360)(373)(376)	24000 +	27500	24750

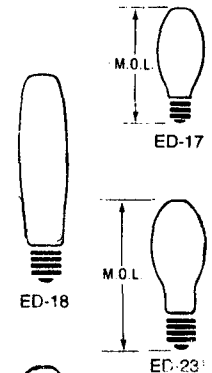

**Mercury Vapor Lamps**

502296	75	ED-17	Med.	H43AV-75/DX		★ G,S(379)	24000 +	2800	2250
502298	100	ED-23½	Mog.	H38JA-100/DX	H38-4JA/DX	★ G,S(379)	24000 +	4400	3400
502302	175	ED-28	Mog.	H39KB-175	H39-22KB	★ G,S,B(355)	24000 +	7900	7400
502300	175	ED-28	Mog.	H39KC-175/DX	H39-22KC/DX	★ G,S(379)	24000 +	8500	7600
502306	250	ED-28	Mog.	H37KB-250	H37-5KB	★ G,S,B(355)	24000 +	12100	10500
502304	250	ED-28	Mog.	H37KC-250/DX	H37-KC/DX	★ G,S(379)	24000 +	13000	10700
502310	400	ED-37	Mog.	H33CD-400	H33-1-CD	★ G,S,B(355)	24000 +	21000	18900
502308	400	ED-37	Mog.	H33GL-400/DX	H33-1-GL/DX	★ G,S(379)	24000 +	23000	19100

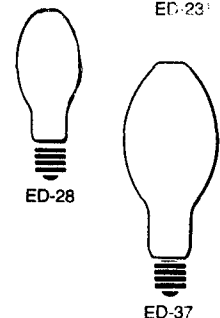

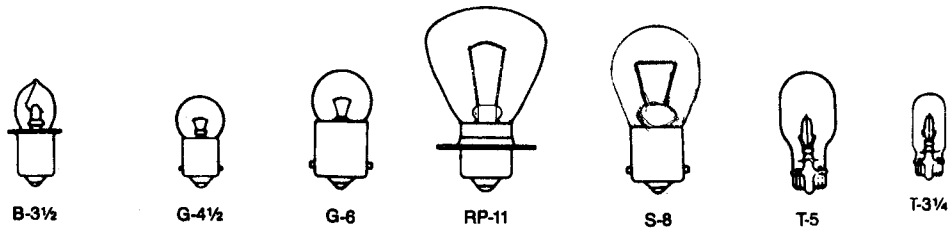

**Minature Lamps**

SKU NO.	Lamp Trade No.	Bulb	Service and Special Description	Vac (B) or Gas (C)	Design Volts	Design Amps.	Design Watts	Approx. Mn Spher. Candela	Avg. Life Hours	Base	Light Ctr. Length		Overall Length	
											In	mm	In.	mm
803327	PR2	B-3½	Flashlight-2 D Cells	B	2.38	.50	1.19	.80	15	S.C. Min. Fig.	¼	6.4	1¼	32
803330	PR3	B-3½	Flashlight-3 D Cells	B	3.57	.50	1.79	1.50	15	S.C. Min. Fig.	¼	6.4	1¼	32
803333	PR4	B-3½	Flashlight-2 C Cells	B	2.33	.27	.63	.40	10	S.C. Min. Fig.	¼	6.4	1¼	32
803336	PR6	B-3½	Flashlight-2 D Ind. Cells	B	2.47	.30	.74	.45	30	S.C. Min. Fig.	¼	6.4	1¼	32
803339	PR12	B-3½	Flashlight-5 D Cells	C	5.95	.50	3.00	3.10	15	S.C. Min. Fig.	¼	6.4	1¼	32
803345	PR15	B-3½	Hand Lantern-6 Volt Battery	C	4.82	.50	2.41	2.00	30	S.C. Min. Fig.	¼	6.4	1¼	32
803348	PR18	B-3½	Flashlight-6 D Cells	C	7.20	.55	3.96	4.80	3	S.C. Min. Fig.	¼	6.4	1¼	32
803351	PR20	B-3½	Flashlight-7 D Cells	C	8.63	.50	4.32	5.00	15	S.C. Min. Fig.	¼	6.4	1¼	32
502342	27	G-4½	Hand Lantern-4 F Cells	B	4.90	.30	1.47	1.40	30	Min. Sc	23/32	18.2	11/16	27
502344	40	T-3¼	Radio	B	6.30	.15	.95	.50	3000	Min. Sc	7/8	22.6	13/16	31
502346	43	T-3¼	Indicator	B	2.50	.50	1.25	.50	3000	Min. Bay.	25/32	19.8	13/16	31
502348	44	T-3¼	Radio, TV and Indicator	B	6.30	.25	1.58	.90	3000	Min. Bay.	11/16	18.0	13/16	31
502350	47	T-3¼	Radio, TV and Indicator	B	6.30	.15	.95	.52	3000	Min. Bay.	11/16	18.0	13/16	31
502354	51	G-3½	Auto and Indicator	B	7.50	.22	1.65	1.00	1000	Min. Bay.	1/2	12.7	15/16	24
502364	68	G-6	Auto and Marine	C	13.50	.59	7.97	4.00	5000*9	D.C. Bay.	13/16	20.6	17/16	37
500102	82	G-6	Auto and Marine	C	6.50	1.02	6.63	6.00	500	D.C. Bay.	3/4	19.0	17/16	37
502378	131	G-3½	Bicycle-1 D Cell	B	1.30	.10	.13	.03	50	Min. Sc.	23/32	18.2	15/16	24
502382	161	T-3¼	Auto	B	14.00	.19	2.66	1.00	4000	Wedge	9/16	14.2	11/16	27
502384	168	T-3¼	Auto	B	14.00	.35	4.90	3.00	1500	Wedge	9/16	14.2	11/16	27
502392	257	G-4½	Auto. Flasher	B	14.00	.27	3.78	3.10	500 <sup>5</sup>	Min. Bay.	5/8	15.9	11/16	27
502416	605	G-4½	Flashlight-5 D Cells	C	6.15	.50	3.08	3.40	15	Min. Sc.	23/32	18.2	11/16	27
502420	755	T-3¼	Indicator	B	6.30	.15	.95	.33	20,000	Min. Bay.	11/16	18.0	13/16	31
502428	908	T-5	Emergency Lighting	C	6.00	1.50	9.00	12.00	50	Wedge	13/16	20.6	1½	39
502438	1142	S-8	Auto <sup>1</sup>	C	12.80	1.44	18.43	21.00	1000	D.C. Bay.	1¼	31.8	2	51
502450	1195	RP-11	Auto <sup>1</sup>	C	12.50	3.00	37.50	50.00	300	S.C. Bay.	1¼	31.8	2¼	58
502460	1493	S-8	Instrument. Microscope Illuminator <sup>12 10</sup>	C	6.50	2.75	17.88	23.00	100	D.C. Bay.	1½	28.6	2	51
502466	1815	T-3¼	Indicator	B	14.00	.20	2.80	1.40	3000	Min. Bay.	11/16	18.0	13/16	31
502468	1816	T-3¼	Aviation and Auto	B	13.00	.33	4.29	3.00	1000	Min. Bay.	5/8	15.9	13/16	31
502470	1819	T-3¼	Aviation and Indicator	B	28.00	.04	1.12	.34	4000	Min. Bay.	5/8	15.9	13/16	31
502472	1829	T3-¼	Coin Machine and Indicator	B	28.00	.07	1.96	1.00	1000	Min. Bay.	5/8	15.9	13/16	31
502476	1893	T-3¼	Radio	B	14.00	.33	4.62	2.00	7500	Min. Bay.	5/8	5.9	13/16	31



**Minature Blister Carded (MBC) Lamps**

SKU NO.	Trade No.	Lamps/ Card	Service and Special Description	Design Volts	Design Watts	MSCd	Rated Avg. Life (Hours)	Base
502362	63	2	Auto, Aviation and Coin Machine	7.00	4.41	3.0	1000	S.C. Bay.
502374	67/97	2	Auto	13.5	7.97	4.00	5000*1	S.C. Bay.
502370	89	2	Auto	13.00	7.50	6.00	750	S.C. Bay.
502372	90	2	Auto and Marine	13.00	7.50	6.00	750	D.C. Bay.
502388	211-2	2	Auto	12.80	12.42	12.00	1000	Dbl. End Cap
502432	1003	2	Auto	12.80	12.03	15.00	200	S.C. Bay.
502434	1004	2	Auto and Marine	12.80	12.03	15.00	200	D.C. Bay.
502436	1141	2	Auto <sup>2</sup>	12.80	18.43	21.00	1000	S.C. Bay.
502440	1154	2	Auto <sup>2</sup>	6.40 7.00	16.83 5.25	21.00 3.00	200 1000	D.C. Index
502444	1156/1073	2	Auto <sup>2</sup>	12.80	26.88	32.00	1200	S.C. Bay.
502446	1157/1034	2	Auto <sup>2</sup>	12.80 14.00	26.88 8.26	32.00 3.00	1200 5000 *	D.C. Index
502448	1157NA	2	Auto Natural Amber <sup>2</sup>	12.80 14.00	26.88 8.26	32.00 3.00	1200 5000 *	D.C. Index

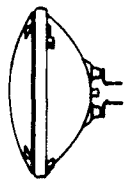

PAR-46  
2 CONTACT LUGS

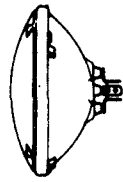

PAR-46  
3 CONTACT LUGS

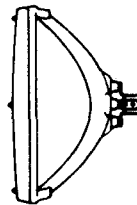

REC-58  
3 CONTACT LUGS

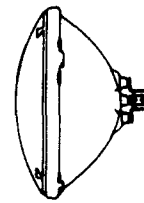

PAR-56  
3 CONTACT LUGS

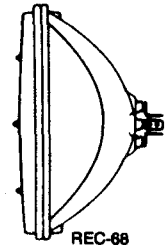

REC-68  
3 CONTACT LUGS

**Sealed Beam Lamps**

SKU NO.	Lamp Trade No.	Bulb	Service and Special Description	Design Volts	Design Watts or Amps	Max. Beam Candela	Approx. Spread to 10% Max.		Average Life Hours	Base	Max. Overall Length	
							Hor.	Vert.			In.	mm
502480	4001	PAR-46	Auto Headlamp High Beam-4Lamp Round System	12.8	37.5	—	—	—	200 <sup>9</sup>	2 Lugs	4	102
502506	4651	REC-58	Auto Headlamp High Beam-4Lamp Rectangular System	12.8	50.0	—	—	—	200 <sup>9</sup>	2 Lugs	4 1/2	114
502508	H4656	REC-58	Auto Headlamp Low Beam-4Lamp Rectangular System (Halogen)	12.8 12.8	35.0 35.0	—	—	—	200 <sup>9</sup> 320 <sup>9</sup>	3 Lugs	4 1/2	114
502510	H5006	PAR-46	Auto Headlamp Low Beam-4Lamp Round System (Halogen)	12.8	35.0 35.0	—	—	—	200 <sup>9</sup> 320 <sup>9</sup>	3 Lugs	4	102
502514	6014	PAR-56	Auto Headlamp 2-Lamp Round System <sup>13</sup>	12.8 12.8	60.0 50.0	—	—	—	200 <sup>9</sup> 320 <sup>9</sup>	3 Lugs	5 1/4	134
502518	H6054	REC-68	Auto Headlamp 2-Lamp Rectangular System (Halogen)	12.8 12.8	65.0 35.0	—	—	—	150 <sup>9</sup> 300 <sup>9</sup>	3 Lugs	5 5/8	143

**7**

**Preheat Fluorescent Lamps**

SKU NO.	WATTS	BULB	BASE	PRODUCT NUMBER	DESCRIPTION	NOM. LNGTH. (in.)	AVG. LIFE HOURS	APPROX. INITIAL LUMENS	DESIGN LUMENS (208)
501642	4	T-5	MIN. BIPIN	F4T5/CW	COOL WHITE	6	6000	135	95
501644	6	T-5	MIN. BIPIN	F6T5/CW	COOL WHITE	9	7500	295	230
501646	8	T-5	MIN. BIPIN	F8T5/CW	COOL WHITE	12	7500	400	300
501648	13	T-5	MIN. BIPIN	F13T5/CW	COOL WHITE	21	7500	820	655
501656	15	T-8	MD. BIPIN	F15T8/CW	COOL WHITE	18	7500	870	765
501658	15	T-8	MD. BIPIN	F15T8/D	DAYLIGHT	18	7500	750	660
501660	15	T-8	MD. BIPIN	F15T8/AGRO	AGRO-LITE, RETAIL PACK	18	7500	410	330
501664	15	T-8	MD. BIPIN	F15T8/BL	BLACK LIGHT(211)	18	7500		
501662	15	T-8	MD. BIPIN	F15T8/BLB	BLACK LT.-INTEGRAL FILTER (211)	18	7500		
501600	30	T-8	MD. BIPIN	F30T8/CW	COOL WHITE, RETAIL PACK	36	7500	2200	2000
501602	30	T-8	MD. BIPIN	F30T8/D	DAYLIGHT	36	7500	1500	1350
501604	30	T-8	MD. BIPIN	F30T8/N	NATURAL	36	7500	1500	1230
501652	14	T-12	MD. BIPIN	F14T12/CW	COOL WHITE, RETAIL PACK	15	9000	575	480
501654	14	T-12	MD. BIPIN	F14T12/D	DAYLIGHT	15	9000	600	500
501666	15	T-12	MD. BIPIN	F15T12/CW	COOL WHITE, RETAIL PACK	18	9000	800	695
501668	15	T-12	MD. BIPIN	F15T12/D	DAYLIGHT	18	9000	650	535
501670	20	T-12	MD. BIPIN	F20T12/CW	COOL WHITE	24	9000	1200	1050
501672	20	T-12	MD. BIPIN	F20T12/D	DAYLIGHT, RETAIL PACK	24	9000	1075	960
501680	20	T-12	MD. BIPIN	F20T12/WW	WARM WHITE, RETAIL PACK	24	9000	1250	1100
501674	20	T-12	MD. BIPIN	F20T12/AGRO	AGRO-LITE, RETAIL PACK	24	9000	600	500
501678	20	T-12	MD. BIPIN	F20T12/BL	BLACK LIGHT (211)	24	9000		
501676	20	T-12	MD. BIPIN	F20T12/BLB	BLACK LIGHT-INTEGRAL FILTER	24	9000		
501688	25	T-12	MD. BIPIN	F25T12/CW	COOL WHITE	33	7500	1900	1710
501690	25	T-12	MD. BIPIN	F25T12/D	DAYLIGHT	33	7500	1600	1440



T-5 Miniature Bipin



T-8 Medium Bipin



T-12 Medium Bipin

**Rapid Start Fluorescent Lamps**

501606	30	T-12	MD. BIPIN	F30T12/CW/RS	COOL WHITE	36	18000	2250	1900
501608	30	T-12	MD. BIPIN	F30T12/D/RS	DAYLIGHT	36	18000	1950	1700

**Econ-O-Watt Rapid Start Fluorescent Lamps**

501630	34	T-12	MD. BIPIN	F40CW/RS/EW-II	COOL WHITE (214)	48	20000	2650	2300
501632	34	T-12	MD. BIPIN	F40D/RS/EW-II	DAYLIGHT214	48	20000	2350	2050

7

**High Output Fluorescent Lamps (800ma)**

SKU NO.	WATTS	BULB	BASE	PRODUCT NUMBER	DESCRIPTION	NOM. LNGTH. (in.)	AVG. LIFE HOURS	APPROX. INITIAL LUMENS	DESIGN LUMENS (208)
501582	110	T-12	REC. D.C.	F96T12/WW/HO	WARM WHITE (207)	96	12000	8900	7750



**Econ-O-Watt Slimline Fluorescent Lamps (Instant Start)**

501612	23	T-8	SINGLE PIN	F42T8/CW/EW	COOL WHITE (210)(214)	42	7500	1800	1620
--------	----	-----	------------	-------------	-----------------------	----	------	------	------

**Slimline Fluorescent Lamps (Instant Start)**

501700	37	T-8	SINGLE PIN	F72T8/CW	COOL WHITE (210)	72	7500	2850	2550
501706	50	T-8	SINGLE PIN	F96T8/CW	COOL WHITE (210)	96	7500	4100	3700
501610	20	T-12	SINGLE PIN	F24T12/CW	COOL WHITE	24	7500	1090	960
501692	35	T-12	SINGLE PIN	F42T12/CW	COOL WHITE	42	7500	2200	1920
501694	38.5	T-12	SINGLE PIN	F48T12/CW	COOL WHITE	48	9000	2900	2600
501696	38.5	T-12	SINGLE PIN	F48T12/D	DAYLIGHT	48	9000	2500	2200
501698	50	T-12	SINGLE PIN	F60T12/CW	COOL WHITE	60	12000	3450	3050
501702	56	T-12	SINGLE PIN	F72T12/CW	COOL WHITE	72	12000	4450	3900
501704	56	T-12	SINGLE PIN	F72T12/D	DAYLIGHT	72	12000	3800	3350



**Econ-O-Watt Slimline Fluorescent Lamps (Instant Start)**

501716	60	T-12	SINGLE PIN	F96T12/CW/EW	COOL WHITE (214)	96	12000	5400	4750
501718	60	T-12	SINGLE PIN	F96T12/D/EW	DAYLIGHT (214)	96	12000	4850	4250



**Slimline Fluorescent Lamps (Instant Start)**

501712	75	T-12	SINGLE PIN	F96T12/CWX	DELUXE COOL WHITE	96	12000	4500	3950
501710	75	T-12	SINGLE PIN	F96T12/D	DAYLIGHT	96	12000	5200	4550
501720	75	T-12	SINGLE PIN	F96T12/WW	WARM WHITE	96	12000	6200	5450
501714	75	T-12	SINGLE PIN	F96T12/WWX	DELUXE WARM WHITE	96	12000	4350	3850

**Circline Fluorescent Lamps**

501722	20	T-9	4-PIN	FC6T9/CW	COOL WHITE	O.D. 6½	12000	800	590
501724	22	T-9	4-PIN	FC8T9/CW	COOL WHITE	O.D. 8¼	12000	1050	775
501726	32	T-9	4-PIN	FC12T9/CW	COOL WHITE	O.D. 12	12000	1800	1495
501728	40	T-9	4-PIN	FC16T9/CW	COOL WHITE	O.D. 16	12000	2500	1975

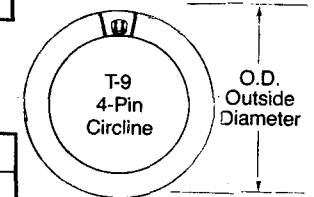

**U-Bent Fluorescent Lamps**

501636	40	T-12	MD. BIPIN	FB40CW/3	COOL WHITE (212)	22 7/16	12000	2600	2200
501638	40	T-12	MD. BIPIN	FB40CW/6	COOL WHITE (212)	22 7/16	18000	2650	2300

**Econ-O-Watt Rapid Start Fluorescent Lamps**

SKU NO.	WATTS	BULB	BASE	PRODUCT NUMBER	DESCRIPTION	NOM. LNGTH. (in.)	AVG. LIFE HOURS	APPROX. INITIAL LUMENS	DESIGN LUMENS (208)
501634	34	T-12	MD. BIPIN	F40WW/RS/EW-II	WARM WHITE (214)	48	20000	2700	2350

**Preheat-Rapid Start Fluorescent Lamps**

501619	34	T-12	MD. BIPIN	F40CW/RS/EW	COOL WHITE	48	20000	3050	2650
501620	40	T-12	MD. BIPIN	F40CWX	DELUXE COOL WHITE	48	20000	2200	1800
501616	40	T-12	MD. BIPIN	F40D	DAYLIGHT	48	20000	2600	2250
501618	40	T-12	MD. BIPIN	F40WW	WARM WHITE	48	20000	3100	2700
501622	40	T-12	MD. BIPIN	F40WWX	DELUXE WARM WHITE	48	20000	2200	1805
501628	40	T-12	MD. BIPIN	F40AGRO	AGRO-LITE, RETAIL PACK	48	20000	1600	1360
501640	40	T-12	MD. BIPIN	F40G	GREEN	48	20000	4400	2200
501643	40	T-12	MD. BIPIN	F40GO	GOLD, BUG-A-WAY	48	20000	2400	1765
501626	40	T-12	MD. BIPIN	F40BL	BLACK LIGHT (211)	48	20000		
501624	40	T-12	MD. BIPIN	F40BLB	BLACK LT.-INTEGRAL FILTER (211)	48	20000		

**High Output Fluorescent Lamps (800 ma)**

501554	35	T-12	REC.DC	F24T12/CW/HO	COOL WHITE207	24	9000	1650	1390
501556	35	T-12	REC. DC	F24T12/D/HO	DAYLIGHT (207)	24	9000	1400	1160
501562	40	T-12	REC. DC	F30T12/CW/HO	COOL WHITE (207)	30	9000	2290	1900
501558	50	T-12	REC. DC	F36T12/CW/HO	COOL WHITE(207)	36	9000	2800	2450
501560	55	T-12	REC.DC	F42T12/CW/HO	COOL WHITE (207)	42	9000	3400	2950
501564	60	T-12	REC. DC	F48T12/CW/HO	COOL WHITE (207)	48	12000	4050	3500
501566	75	T-12	REC. DC†	F60T12/CW/HO	COOL WHITE	60	12000	5150	4500
501568	85	T-12	REC. DC	F72T12/CW/HO	COOL WHITE (207)	72	12000	6350	5500
501570	85	T-12	REC. DC	F72T12/D/HO	DAYLIGHT (207)	72	12000	5600	4850
501572	85	T-12	REC. DC	F72T12/WW/HO	WARM WHITE (207)	72	12000	6500	5700
501574	95	T-12	REC. DC	F84T12/CW/HO	COOL WHITE (207)	84	12000	7800	6800
501571	95	T-12	REC. D.C.	F96T12/CW/HO/EN	COOL WHITE (207)	96	12000	8800	7650



7

**Appliance Fluorescent Lamps**

SKU NO.	WATTS	BULB	BASE	PRODUCT NUMBER	DESCRIPTION	NOM. LNGTH. (in.)	AVG. LIFE HOURS	APPROX. INITIAL LUMENS	DESIGN LUMENS (208)
501650	14	T-8	MD. BIPIN	F14T8/CW/15	COOL WHITE	15	7500	700	595
501592	15	T-8	MD. BIPIN	F15T8/CW/24	COOL WHITE	24	7500	1175	940
501594	16	T-8	MD. BIPIN	F16T8/CW/26	COOL WHITE	26	7500	1275	1020
501596	17	T-8	MD. BIPIN	F17T8/CW/28	COOL WHITE	28	7500	1350	1080
501598	18	T-8	MD. BIPIN	F18T8/CW/30	COOL WHITE	30	7500	1400	1120
501682	20	T-12	MD. BIPIN	F20T12/CW/26	COOL WHITE	26	7500	1250	1000
501684	25	T-12	MD. BIPIN	F25T12/CW/28	COOL WHITE	28	7500	1600	1280
501686	25	T-12	MD. BIPIN	F25T12/D/28	DAYLIGHT	28	7500	1370	1095



**FLUORESCENT TUBE-GUARDS**

**END-CAPS FOR TUBE-GUARDS**

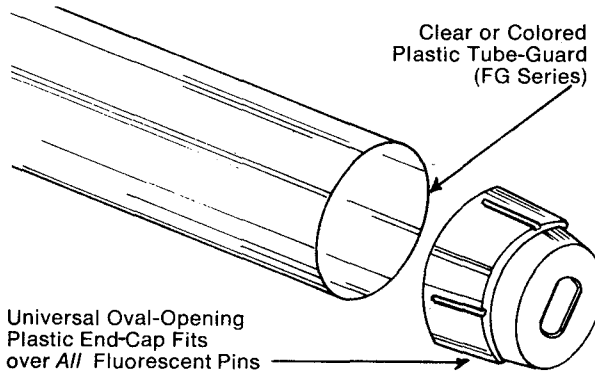
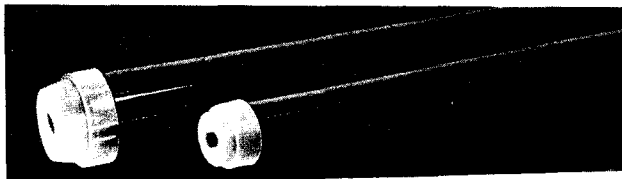

SKU NO.	MFG NO.	DESCRIPTIONS
507002	FG-40	F40 T-12 Tube guard with 2 ends clear
507004	FG-96	F96 T-12 Tube guard with 2 ends clear
507007	FG-308	F30 T-8 Tube guard with 2 ends clear

SKU NO.	MFG NO.	DESCRIPTIONS
507008	T-12	T12 End guards (each)
507014	508-C	Clear plastic globe
507016	508-W	White plastic globe

Our catalog does not contain everything in our inventory. If there are products you do not find that are related to those in this catalog call 437-1288 so that we may assist you.



**FLUORESCENT LAMP BALLASTS  
 SLIMLINE & INSTANT START CLASS P  
 HIGH POWER FACTORY TYPE 1500 mA-425mA-440mA**



**ADVANCE® Mark III Energy Savers—**

Electromagnetic ballasts that offer maximum energy cost savings and meet CBM light output requirements.

- When used with energy saving lamps, provide energy savings of up to 22 percent compared to conventional ballasts used with standard lamps.
- Twice the service life of conventional ballasts.
- Operate the lamps of any manufacturer.
- Fast payback in retrofit installations.

SKU NUMBERS	MFG NUMBERS	INPUT VOLTS	START	NUMBER OF LAMPS	LAMP DESCRIPTION	OUTPUT WATTS	CLASS
501139	VSM-175-S-TP	277V	Rapid Start	1-lamp	F60, F64, F72, F96T12	48-75	class P
507960	RSM-175-S-TP	120V	Instant Start	1-lamp	F60, F64, F72, F96T12	48-75	class P
501141	RLQ-120-TP	120V	Rapid Start	1-2-3-lamp	F14, F15, F20	14-20	class P
507905	LQ-106-TP	120V	Trigger Start	1-2-3-lamp	F4, F6, F8	4-8	class P
507925	RL-3SP20-TP	120V	Trigger Start	1-2-3-lamp	F15, F20	15-20	class P
507930	RL-2SP20-TP	120V	Rapid Start	1-2-3-lamp	F14, F15, F20	14-20	class P
507890	L140F-TP	120V	Preheat	1-lamp	Circline F12, F16	32-40	class P
507895	LC14-20C	120V	Preheat	1-lamp	Circline F8	22	
507900	LC4-9C	120V	Preheat	1-lamp	F4	4	
507910	R-2S40-TP	120V	Rapid Start	2-lamp	F40	40	class P
507935	RM-2SP-30-TP	120V	Rapid Start	2-lamp	F30	30	class P
507990	V-2S40-TP	277V	Rapid Start	2-lamp	F40	40	class P
507915	R-2E75-S-TP	120V	Instant Start	2-lamp	F60, F64, F72	50-57	class P
507980	S-275-S-TP	120V	Slimline Instant Start	2-lamp	F60, F64, F72	50-57	class P
507985	SM-2E40-S-TP	120V	Instant Start	2-lamp	F36, F42	30-34	class P
507934	V-2E75-S-TP	277V	Instant Start	2-lamp	F96	60	class P
507920	RL-140-TP	120V	Rapid Start Circline	1-2-lamp	F40	40	class P
507945	RS-2S110-TP	120V	Rapid Start	2-lamp	F72	87	class P
508010	VS-2S110-TP	277V	Rapid Start	2-lamp	F72	87	class P
507950	RS-2S200-TP	120V	Rapid Start	2-3-lamp	F72	168	class P
508005	VS-2S200-TP	277V	Rapid Start	2-3-lamp	F72, F96	168-215	class P
507955	RS-3P40-TP	120V	Rapid Start	1-lamp	F40	40	class P
508020	VS-110-TP	277V	Rapid Start	1-lamp	F96	95	class P
507971	RS-110-TP	120V	Rapid Start	1-lamp	F72, F96	87-112	class P

**DISCRETE ELECTRONIC BALLAST CLASS P**

**ADVANCE® Discrete Electronic Ballasts—**

Reliable solid-state design and high frequency operation combine maximum energy savings and light output. Have proved themselves in thousands of applications nationwide.

- Used with energy saving lamps provides power savings of up to 37 percent compared to conventional ballasts/standard lamps.
- Operate 75 percent quieter than conventional electromagnetic ballasts.
- Operate 30°C cooler than conventional electromagnetic ballasts.
- Weigh less than comparable electromagnetic ballasts.

SKU NUMBERS	MFG NUMBERS	INPUT VOLTS	START	NUMBER OF LAMPS	LAMP DESCRIPTION	OUTPUT WATTS
508939	REL2P75P	120	Rapid	2	F72, F96	60-75
508944	REL2S40TP	120	Rapid	2	F40	40

7

**MANUALLY OPERATED  
 DOOR CHIME**



637

Resonant two-note melodious chime sound when button is pushed and released. Fits all doors and walls 3/4" to 4 3/4" thick. Face plate mounts on outside and chime base and cover mount on inside. Face Plate — brass. Name card provided. Slimline chime — ivory finish. Mounting templates, instructions and screws provided.

Cat. No. 637  
 SKU NO. 506590

**DECORATOR DOOR CHIMES**



BC 1032

*Cat. No. 1032* A simple economical design. Color: white. Two note front—one note rear. Size: 7 1/4" x 4"  
**SKU NO. 507030**



BC 1035

*Cat. No. 1035* A contemporary design inspired by modern art. Color: white with gold trim. Two note front—one note rear.  
**SKU NO. 507000** Size: 7 1/4" x 4"



BC 1042

*Cat. No. 1042* A classic design with an etched brass plate center surrounded by a walnut finish. Two note front—one note rear. Size: 8 1/2" x 5 1/2"

**SKU NO. 507010**

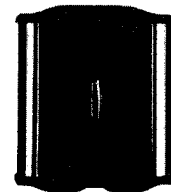

BC 1054

*Cat. No. 1054* Two brass-plated tubes enclose a walnut-grained cabinet inspired by the scroll of antiquity. Two note front—one note rear. Size: 9" x 7"

**SKU NO. 507015**



BC 1061

*Cat. No. 1061* A Scandinavian design of walnut-finished slats backed by a dark grille cloth. Two note front—one note rear. Size: 9 1/2" x 7 1/2"

**SKU NO. 507020**

**AUDIBLE SIGNALS**

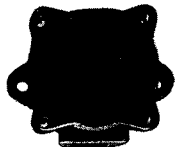

811

**WEATHERPROOF  
 PUSH BUTTONS**

*SURFACE TYPE — LOW VOLTAGE*

**Applications:** Push button panels, original equipment, school signaling, start/stop machines, entrance pushes, industrial signaling. Cast aluminum — Grey finish.

Cat. No. 811

**SKU NO. 506905**

Cat. No. 810 X With Conduit Plate

**SKU NO. 506900**

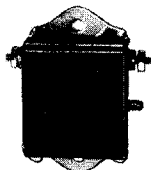

802

**SERVICE BUZZERS**

**For AC or DC Operation**

**Features:** Never need replacement — only small and compact buzzer suitable for truly permanent installation. Readily adjustable for wide range of sound volume. Bug and dust proof covers. Standard operation on 6V DC or 8V AC. Have grounded frames. Readily accessible, external, insulated binding posts.

Cat. No. 802, Size 2:

Overall size 2 5/8" x 2 3/16" x 3/4"

**SKU NO. 506630**

Cat. No. 802A, 24VAC20VDC

**SKU NO. 506635**



BC 100

BC 101

Totally Enclosed Bell  
 8-12V AC, 3-6V DC  
**SKU NO. 506595**

Totally Enclosed  
 Combination Bell-  
 Buzzer 8-12V AC,  
 3-6V DC BC101  
**SKU NO. 506600**

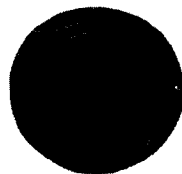

951

**VIBRATING INDUSTRIAL  
 BUZZER - ENCLOSED  
 HEAVY DUTY**

Sturdy construction, dependable operation. Continuous duty. Mounts directly on surface of a single gang opening. Fully insulated. For areas where a signal of a different tone is required.

Finish — Grey.

Cat. No. 951: 120V, 60 Cy. AC

**SKU NO. 506695**



**ELECTRIC DOOR STRIKES**



2

**MORTISE TYPES**

Used with Mortise entrance lock having a deadlocking latch bolt. Reversible for Right or Left Hand Doors. NEW, SHALLOW 1 9/16" maximum depth - ideal for narrow metal door strikes.

Cat. No. 2: Flat Face  
**SKU NO. 506935**



**MORTISE TYPES**

Mortise type for A. N. S. I. standard strike-cut-out. Heavy duty type. 6" wire leads. For locks with dead locking latch bolt up to 9/16" throw.

Cat No 12-brass  
**SKU NO. 506964**

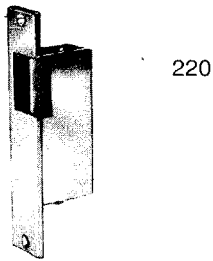

220

**MORTISE TYPES**

Used with Mortise entrance lock having a latch bolt. Reversible for Right or Left Hand Doors.

**NORMALLY LOCKED.**

Cat. No. 220: For shallow doors. For lock sets and latches up to 1/2" width and throw. 1 9/16" depth. 6" wire leads.

**SKU NO. 506945**

**ELECTRICAL SPECIALTIES**

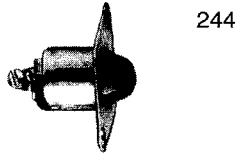

244

**ECONOMY DOOR AND WINDOW CONTACTOR**

New non-tilt non-jamming design. Fully insulated — Positive wiping action contacts, bullet plunger operates from pressure in any direction. For ringing signals automatically by the opening and closing of doors, windows, transoms, etc. Fits 3/4" hole. No need to mortise. Shallow enough for all standard frames and casings.

For use to 48V

When nose is depressed:

**SKU NO. 506950**      **MFG. NO. 244: Breaks Circuit**

**TRANSFORMERS  
COMPLETE WITH GROUND WIRE**  
120V Primary, unless otherwise indicated

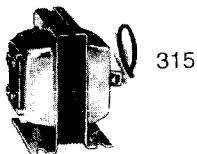

315

10 Volt, 5 Watt 'Multi-Mount Bracket'  
**SKU NO. 506710**

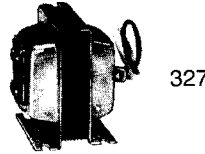

327

Heavy Duty, 8-16-24 Volt, Trivolt, 25 Watt  
**SKU NO. 506730**

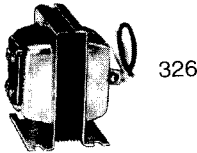

326

Heavy Duty, 24 Volt, 25 Watt  
**SKU NO. 506725**

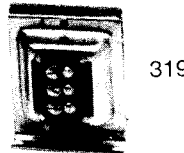

319

6-12-18 Volt, Trivolt with Multi-Mount Bracket, 5 Watt  
**SKU NO. 506715**

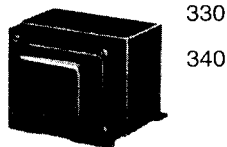

330

Signaling Transformer,  
**SKU NO. 506735**      **MFG. NO. 330**      **VA 50**      **CAP 120V**  
**507815**      **330**      **50**      **120V**  
**506745**      **340**      **100**      **120V**

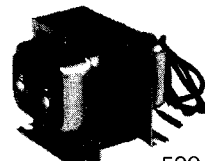

599

Heavy Duty 24V, 40 Watts 120V Primary Edwards  
**SKU NO. 506745**

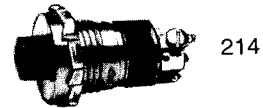

214

**HIGH VOLTAGE PUSH BUTTON**

Locknut type, with modified 1/2" conduit locknut. Ideal for panel mounting. Mounts in hole drilled 25/32" and tapped with straight pipe threads.

**SKU NO. 506780**

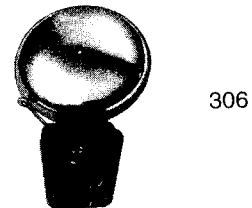

306

Cat. No. 306 6" Diameter Gong Concealed Terminals  
**SKU NO. 506625**

7



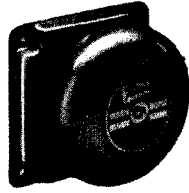

3600

**ECONOMY LINE UNDERDOME BELLS**

The same solenoid plunger mechanism as in the above bells. Mounted on 4" raised plate for mounting on surface or No. 1900 Outlet Box for easy indoor installation.

Cat. No. 3600 Vibrating Bells for AC operation.

Gong Sizes: 4", 6", 8", 10". Standard Finish — Grey. Available in Red.

Standard Voltages: 12V AC, 24V AC — 120V AC 60 cycles

Back Box not furnished

SKU NO.	MFG. NO.	SIZE	VOLTS
506640	3600	4"	12V
506645	3600	4"	24V
506650	3600	4"	120V
506660	3600	6"	24V
506665	3600	6"	120V
506670	3600	8"	24V
506675	3600	8"	120V
506680	3600	10"	12V
506685	3600	10"	24V
506690	3600	10"	120V

**ELECTRICAL SPECIALTIES**

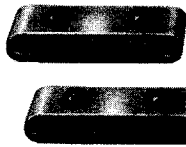

1211

**MINIATURE MAGNETIC SWITCH CONTACTS**  
 For Doors and Windows

Suitable for limited space applications. Self-insulating to meet all mounting requirements. Can be mounted in any direction. Housings are of impact-resistant polystyrene. Furnished with companion magnet.

Cat. No. 1211: For closed circuit alarms.  
**SKU NO. 506975** 24V AC/DC Max.



1224

Cat. No. 1224: For open circuit alarms, and announcing.

**SKU NO. 506990** 24V AC/DC Max.



1268

Cat. No. 1268: Make & break magnetic switch, normally open and normally closed.

Size: 2 3/16" L x 1/2" W x 1/2" D

**SKU NO. 506995** 24V AC/DC Max.



269 LG

**TRIPLE PUSH BUTTON**

Dependable, rugged construction. Black center button. Momentary contacts. Gold; Silver.

Size: 1 3/8" x 7 9/16" Compact, for flush mounting. Easy to mount. Neat, low-cost installation.

**SKU NO. 509111**

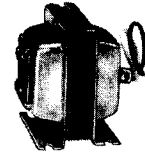

323 M

**CHIME TRANSFORMERS**

The single-screw bracket is the TIME-SAVER. Mounts in the quickest time on outlet boxes, wiring compartments, fuse boxes, etc. Or, can be attached in the conventional way by screws in the mounting feet. Especially adaptable for quick and easy assembly to 4" porcelain keyless ceiling receptacles. Now with ground wire. 16 Volt, 15 Watt,

**SKU NO. 506720**

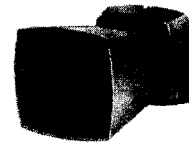

872 A

872 B

**PROJECTOR TYPE**

For directing sound to specific areas. Can be mounted directly on surface or on single gang opening. 3 1/4", 3 1/2", 4" octagon.

**SKU NO.**

**506700** Cat. No. 872 A: 24V AC  
**506705** Cat. No. 872 B: 120V AC

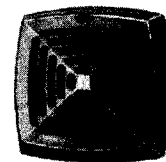

874 A

874 B

**GRILLE TYPE**

For panel boards and machinery. Can be mounted directly on surface or on single gang opening. 3 1/4", 3 1/2", 4" octagon.

**SKU NO. 500083** Cat. No. 874 A: 24V AC  
**SKU NO. 500084** Cat. No. 874 B: 120V AC

**AUDIBLE SIGNALS**

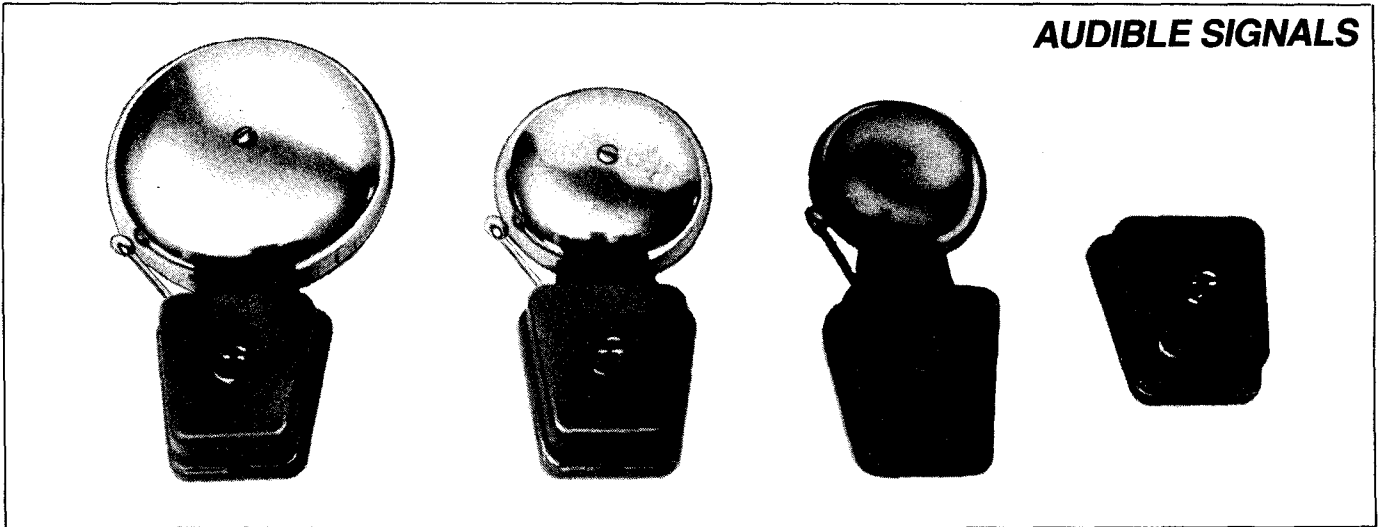

Cat. No. BC 304

Cat. No. BC 303

Cat. No. BC 302

Cat. No. BC 305

**Surface Mounting Electric Bells and Buzzers**

An entirely new eye-appealing design and construction for consumer acceptance. Bells and buzzers have sturdy steel bases and covers. Base is designed to prevent buckling when screwed to the wall. The cover snaps onto the base with a light pressure, and no screws are required to hold it on. Base has a straight hammer resulting in maximum efficiency and power. Extra large magnet coil and

resonant steel gongs furnished. Contact springs are phosphor-bronze. Designed to operate on either bell-ringing transformers or batteries. All units of this line are thoroughly tested under actual operating conditions before shipment. Packed in attractive individual boxes or blister carded — add prefix 'BC' to catalog number.

- Fully Enclosed Mechanism
- Standard Voltages  
 8-16 Volts AC  
 3-6 Volts DC
- Standard Finish — Aluminum
- Non-adjustable; Preset — *Do not adjust*
- For surface or Concealed Wiring

**FURNISHED WITH KNOCK-OUT IN COVER FOR NEAT EXPOSED WIRING JOB**

Cat. No. 302: 2½" Diameter Gong,  
 Concealed Terminals

**SKU NO. 506605**

Cat. No. 303: 3" Diameter Gong,  
 Concealed Terminals

**SKU NO. 506610**

Cat. No. 304: 4" Diameter Gong,  
 Concealed Terminals

**SKU NO. 506615**

Cat. No. 305: Buzzer, Concealed,  
 Terminals

**SKU NO. 506620**



**PLUG-IN TRANSFORMER**

SKU NO.	MFG. NO.	AMPS	VOLTS
506750	P1-16	10	115

**PUSH BUTTONS**

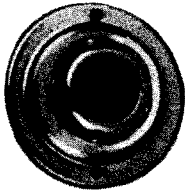

**CAT. NO. BC200P**

\*Cat. No. BC 200  
 Size: 1 3/4" Diam.

**SKU NO. 506755 PLUSH BRASS**

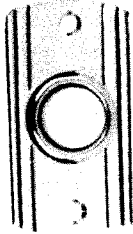

**Cat. No. BC 215**

Cat. No. BC 215: Brass; Chrome.  
 Size: 1 1/4" x 2"

SKU NO.	MFG. NO.	FINISH
506785	BC215B	BRASS
506880	BC215LB	PEARL-BRASS
506885	BC215LC	PEARL-CHROME

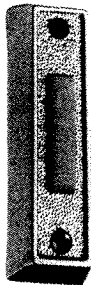

**Cat. No. BC 266**

Cat. No. BC 266: Gold; Silver.  
 Size: 1 5/16" x 2 3/4"

SKU NO.	MFG. NO.	FINISH
506850	BC266LG	BAR SLIM-BAR GOLD
506855	BC266LS	SLIM BAR SILVER
500026	BC266LW	WHITE
507821	BC266LW	WHITE

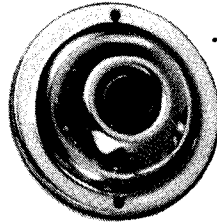

**CAT. NO. BC201P**

\*Cat. No. BC 201 P  
 Size: 2 1/4" Diam.

**SKU NO. 506760 PLUSH BRASS**



**\*Cat. No. BC 219**

\*Cat. No. BC 219: Sprayed Brass;  
 Polished Brass; Chrome.  
 Size: 7/8" x 2 1/4"

SKU NO.	MFG. NO.	FINISH
506805	BC219C	NARROW-CHROME
506800	BC219P	PLUSH BRASS

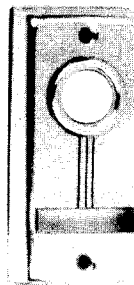

**CAT. NO. BC267LG**

Cat. No. BC 267L: Gold; Silver.  
 Size: 1 3/8" x 2 3/4"

SKU NO.	MFG. NO.	FINISH
506860	BC267LG	GOLD
506865	BC267LS	SILVER



**Cat. No. BC 666**

Cat. No. BC 666: Black, Ivory Bar; Ivory,  
 Black Bar; Chrome, Black Bar;  
 Size: 2 3/4" x 3/4"

SKU NO.	MFG. NO.	FINISH
506825	BC666B	BLACK-IVORY
506815	BC666P	GOLD-WHITE
506820	BC666S	SILVER-BLACK
506810	BC666W	IVORY BLACK

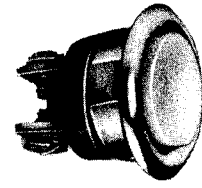

**\*Cat. No. BC 205**

\*Cat. No. BC 205: Brass; Chrome.  
 Size: 5/8" Diam.

SKU NO.	MFG. NO.	FINISH
506765	BC205B	BRASS
506770	BC205C	CHROME
506840	BC205LB	PEARL-BRASS
506845	BC205LC	PEARL-CHROME



**Cat. No. BC 262**

Cat. No. BC 262: Brass; Chrome.  
 Size: 1 3/16" x 2 7/8"

SKU NO.	MFG. NO.	FINISH
506835	BC262C	CHROME
506890	BC262LB	PEARL BRASS
506895	BC262LC	PEARL CHROME



**\* Cat. No. BC 268LG**

Cat. No. BC 268L: Gold; Silver.  
 Size: 1 3/8" x 5 1/4"

SKU NO.	MFG. NO.	FINISH
506870	BC268LG	GOLD
506875	BC268LS	SILVER

**7**

# Honeywell

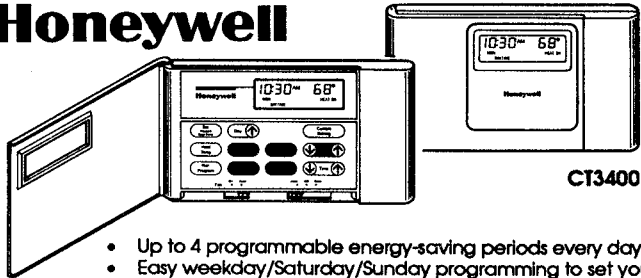

CT3400

- Up to 4 programmable energy-saving periods every day.
- Easy weekday/Saturday/Sunday programming to set your own energy saving schedule.
- Maintains room temperature to within 1° F of the set point.
- Can be removed from the wall for easy and convenient armchair or tabletop programming.
- Compatible with most heating and/or air conditioning systems.

SKU NO. 504113

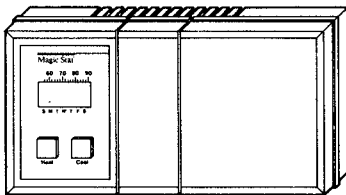

MS3000

- Save up to 35% on energy bills.
- 6 different temperature settings a day.
- 7 different daily programs available.
- Automatically switches between heat and cool.
- Program all heat and cool temperatures for entire year — in just minutes.

SKU NO. 504116

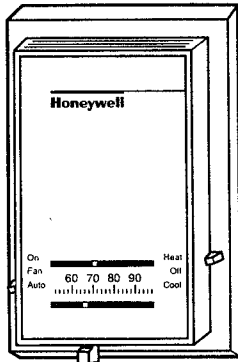

CT51

- Replaces most two-wire low voltage thermostats.
- Quiet, dust-free mercury switch.
- Room temperature thermostat.
- Dual fuel—central gas or oil heating and central electric cooling.

SKU NO. 508511

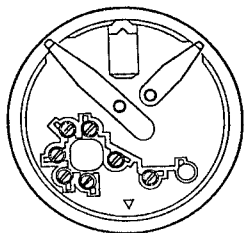

Q539A-1014

- Cooling sub base for T87F.

SKU NO. 501985

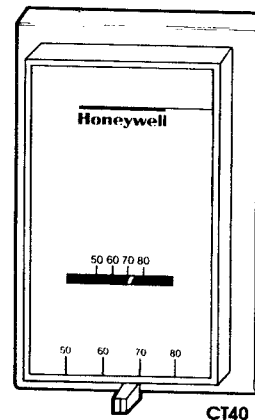

CT40

- Replaces most 750 millivolt thermostats.
- Snap-acting switch—leveling not required.
- Thermometer for at-a-glance room temperature

SKU NO. 508521

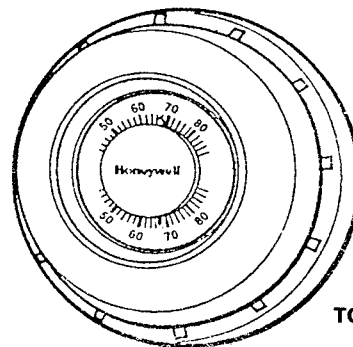

TG587E-1008

- Thermostat cover chronoterm vertical

SKU NO. 502105

7