



PLUG-IN CIRCUIT BREAKERS
10,000 AIC-BLANK HANDLE
TYPE THQL 1" MODULE
TYPE 1-POLE



SKU NO.	MODEL	AMPS
502730	THQL1115	15
502630	THQL1115GF Ground Fault Internal	15
502735	THQL1120	20
502635	THQL1120GF Ground Fault Internal	20
502740	THQL1125 1	25
502745	THQL1130 1	30
502640	THQL1130GF Ground Fault 1-Pole Internal	30
502750	THQL1140	40
502755	THQL1150	50

TYPE 2-POLE



SKU NO.	MODEL	AMPS
502810	THQL21100	100
502815	THQL21125	125
502760	THQL2115	15
502765	THQL2110	20
502766	THQL2125	25
502775	THQL2130	30
502780	THQL2140	40
502785	THQL2150	50
502790	THQL2160	60
502795	THQL2170	70
502800	THQL2180	80
502805	THQL2190	90

TYPE THREE POLE

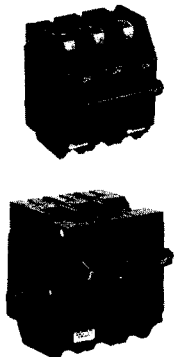

SKU NO.	MODEL	AMPS
502820	THQL32015	15
502825	THQL32020	20
502830	THQL32030	30
502835	THQL32040	40
502840	THQL32050	50
502845	THQL32060	60
502850	THQL32070	70
502855	THQL32080	80
502860	THQL32090	90
502865	THQL32100	100

TYPE 1-POLE & 2-POLE 1/2" MODULE

SKU NO.	MODEL	AMPS
502700	THQP115	15
502705	THQP120	20
502710	THQP130	30
502715	THQP215	15
502720	THQP220	20
502725	THQP230	30
502726	THQP240	40
502728	THQP250	50



SQUARE D COMPANY

QO CIRCUIT BREAKERS

PLUG ON TYPE: For use with Square D QO Load Centers Only WITH VISI-TRIP INDICATOR

QO CIRCUIT BREAKER WITH VISI-TRIP® INDICATOR SINGLE POLE— 1 SPACE

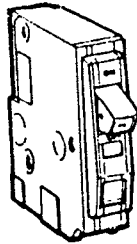

QO CIRCUIT BREAKER WITH VISI-TRIP® INDICATOR TWO POLE— 2 SPACES

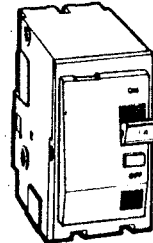

QO CIRCUIT BREAKER WITH VISI-TRIP INDICATOR THREE POLE— 3 SPACES

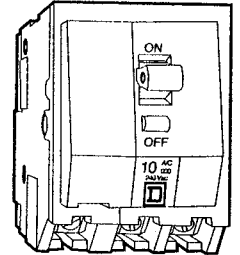

PLUG-IN TYPE

SKU NO.	MFG. NO.	AMPS
503625	QO115	15
503630	QO120	20
503640	QO130	30
503645	QO140	40
503650	QO150	50

SKU NO.	MFG. NO.	AMPS
503655	QO215	15
503660	QO220	20
503665	QO230	30
503670	QO240	40
503675	QO250	50
503680	QO260	60
503685	QO270	70
503692	QO100	100

SKU NO.	MFG. NO.	AMPS
503697	QO315	15
503698	QO320	20
503699	QO330	30
503700	QO340	40
503701	QO350	50
503702	QO360	60
503703	QO370	70
503704	QO380	80
503705	QO390	90
503709	QO3100	100

BOLT-ON TYPE

503041	QOB120
500044	QOB130
505699	QOB135
500042	QOB140
500043	QOB150

503710	QOB115
503699	QOB135
503708	QOB220

7

QO GROUND FAULT CIRCUIT INTERRUPTER SINGLE POLE WITH VISI-TRIP INDICATOR 1 SPACE (30A)

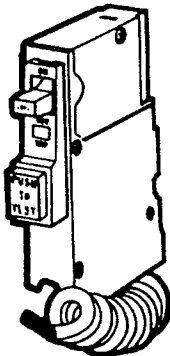

SKU NO.	MFG. NO.
502671	QO115GFI
502695	QO120GFI
502695	QO120GFI

QWIK-GARD® CIRCUIT BREAKER AND GROUND FAULT CIRCUIT INTERRUPTER 2 SPACE

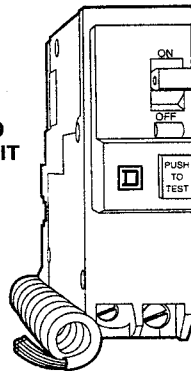

SKU NO.	MFG. NO.
502698	QO250GFI

QO DUAL CIRCUIT BREAKER 1-TWO POLE 1 SPACE

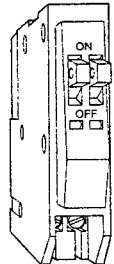

SKU NO.	MFG. NO.
503607	QO1515
503613	QO2020

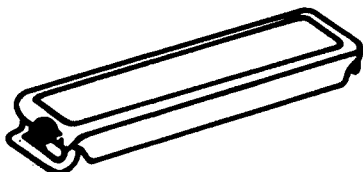

FILLER PLATE
 QO1FP
 SKU NO. 507031



FILLER PLATE
 QO2FP
 SKU NO. 507032

QO TANDEM CIRCUIT BREAKER 2-Single Poles— 1 Space

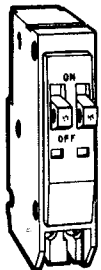

SKU NO.	MFG. NO.
503610	QOT1515C
503615	QOT 2020C

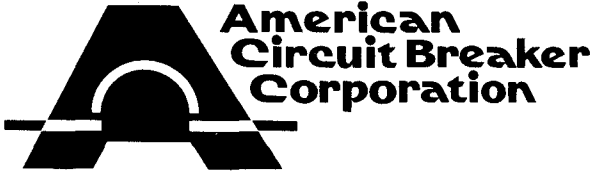

**Federal Pacific
 Comtable**

**Types NA,
 NC STAB-LOK® BREAKERS**

For Replacement Only

Types NA — Stab-In 120/240, 240 Volts AC
 10,000 AIC, Black Handle

SKU NO.	MFG NO.	TYPE	POLE	AMPS.
503755	15	NA	1	15
503760	20	NA	1	20
503770	30	NA	1	30
503775	40	NA	1	40
503780	50	NA	1	50
503785	215	NA	2	15
503790	220	NA	2	20
503800	230	NA	2	30
503805	240	NA	2	40
503810	250	NA	2	50
503815	2P60	NA	2	60
503835	2P100	NA	2	100
503845	3P15	NA	3	15
503850	3P20	NA	3	20
503855	3P30	NA	3	30
503860	3P40	NA	3	40
503865	3P50	NA	3	50
503870	3P60	NA	3	60



Type NA
 1 Pole



Type NC
 1 Pole



Type NC
 2 Pole

Type NC — ½ Space

503720	015	NC	1	15
503725	020	NC	1	20
503730	030	NC	1	30
500049	040	NC	1	40
500051	050	NC	1	50
503735	0215	NC	2	15
503740	0220	NC	2	20
503745	0230	NC	2	30
503750	0240	NC	2	40
503753	0250	NC	2	50

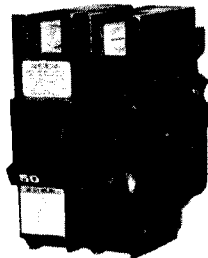

Type NA
 2 Pole

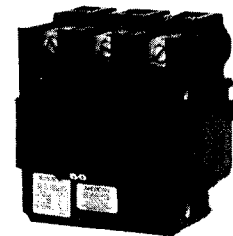

Type NA
 3 Pole



Cutler Hammer Replacement Breakers

SKU NO.	MFG. NO.	AMPS	SKU NO.	MFG. NO.	AMPS	SKU NO.	MFG. NO.	AMPS
503895	CH 115	15	503920	CH 215	15			
503900	CH 120	20	503925	CH 220	20	503985	CH 320	20
503905	CH 130	30	503935	CH 230	30	503990	CH 330	30
						503995	CH 340	40
			503945	CH 250	50	504000	CH 350	50
—	—	—	503950	CH 260	60	504005	CH 360	60
—	—	—	503955	CH 270	70	504010	CH 370	70
—	—	—	503960	CH 280	80			
—	—	—						
—	—	—	503970	CH 2100	100			

CIRCUIT BREAKERS

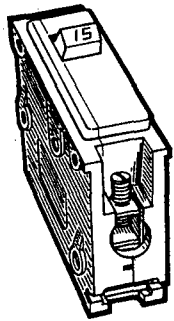

**BRYANT
1-POLE**

SKU NO.	MFG. NO.	AMPS
503555	BR 115	15 AMP
503565	BR 130	30 AMP

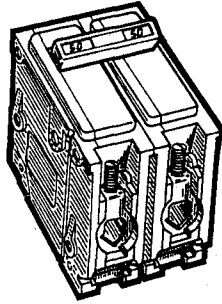

**BRYANT
2-POLE**

SKU NO.	MFG. NO.	AMPS
503585	BR 220	20 AMP
503590	BR 230	30 AMP
503595	BR 240	40 AMP

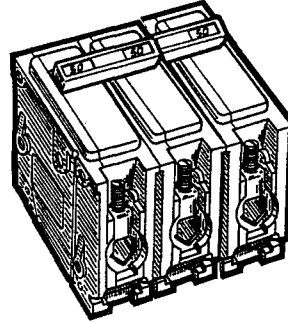

**GTE
3-POLE**

SKU NO.	MFG. NO.	AMPS
503638	BR3100	100AMP
503614	BR330	30 AMP
503617	BR340	40 AMP
503626	BR360	60 AMP

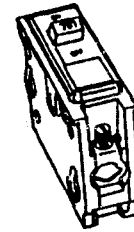

**GTE
1-POLE**

SKU NO.	MFG. NO.	AMPS
503290	C120	20 AMP

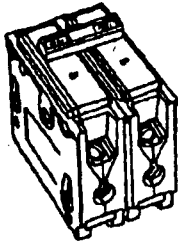

**GTE
2-POLE**

SKU NO.	MFG. NO.	AMPS
503315	C220	20 AMP
503325	C230	30 AMP
503330	C240	40 AMP

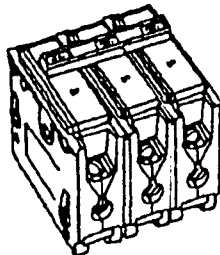

**GTE
3-POLE**

SKU NO.	MFG. NO.	AMPS
503370	C315	15 AMP
503375	C320	20 AMP
503395	C360	60 AMP

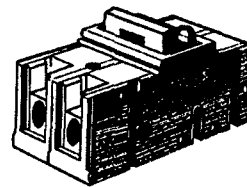

**GTE
1-POLE DUAL**

SKU NO.	MFG. NO.	AMPS
503419	A-2020	20-20A GTE

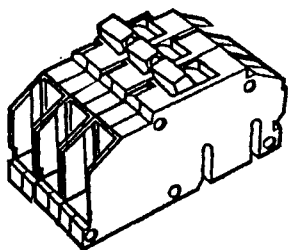

**SYLVANIA
3-POLE**

SKU NO.	MFG. NO.	AMPS
503530	Q2430-50	50 AMP

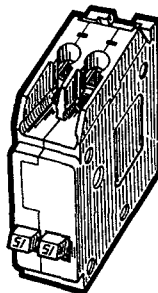

1-POLE

SKU NO.	MFG. NO.	AMPS
500503	BR15-15	15-15 AMP
500509	BR20-15	20-15 AMP
500512	BR20-20	20-20 AMP
500518	BR30-30	30-30 AMP

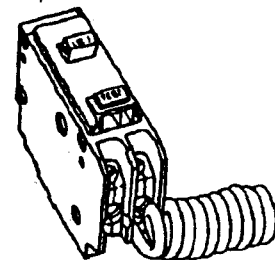

**1-POLE
GROUND FAULT
INTERRUPTER**

SKU NO.	MFG. NO.	AMPS
502675	HAGF 15	15 AMP
502680	HAGF 20	20 AMP

7



CLIPS AND INSULATORS IN OUR POLY ZIP-LOCK BAGS



FLEXIBLE INSULATORS

SKU NO	MFG NO	FOR USE WITH CLIP NO
500538	SC-13-BG	SC-11A, SC-11-C
500539	SC-23-BG	SC-21A, SC-21C, SC-96
500541	SC-26-BG	SC24A, SC-25, SC-25-C, SC-80
500542	SC-29-BG	SC27, SC-27-C, SC27CG, SC-27-CGW
500544	SC-32-BG	SC30, SC30G, SC-30BL, SC-30-TBO
500551	SC-47-BG	SC-45, SC-45-C
500553	SC-49-BG	SC-48, SC-48C, SC-48B-2E, SC-50-C, SC-51C, SC-95
500554	SC-62-BG	SC-60, SC-60-S, SC-60-CS, SC-60PR-2, SC-60-NS, SC-60-TBO, SC-60-U, SC-60-X
500556	SC-72-BG	SC-70, SC-70S, SC-70-CS
500557	SC-74-BG	Insulator For 95
500559	SC-87-BG	SC-85, SC-85-C, SC-85-T



MICRO-GATOR CLIPS

SKU NO	MFG NO	LENGTH	PK	TYPE
500614	SC3436-BG	1 3/32"	2	Steel
500617	SC34C36-BG	1 3/32"	2	Copper



MINIGATOR CLIPS (Small)

SKU NO	MFG NO	LENGTH	PK	TYPE
500599	SC30-BG	1 3/32"	4	Steel
500602	SC3032-BG	1 3/32"	2	Steel
500608	SC30C-BG	1 3/32"	4	Copper
500611	SC30C32-BG	1 3/32"	2	Copper



BATTERY CLIPS

SKU NO	MFG NO	LENGTH	PK	TYPE
500568	SC21A-BG	4"	2	Steel
500569	SC46A-BG	3"	2	Copper
500523	SC11-C-BX	6"	1	Copper
500511	SC24-A-BX	2 27/32"	1	Steel
500514	SC27-BX	2 7/16"	1	Steel
500527	SC27-C-BX	2 7/16"	1	Copper
500533	SC51-C-BX	1"	1	Copper



ALLIGATOR CLIPS

SKU NO	MFG NO	LENGTH	JAW OPEN	PK	TYPE
500563	SC63C-BG	2 1/8"	5/16"	2	Copper
500574	SC60S-BG	2"	5/16"	4	Steel
500578	SC60CS-BG	2"	5/16"	2	Copper
500581	SC70S-BG	1 1/16"	5/16"	4	Steel
500587	SC60HS-BG	2 1/32"	5/16"	4	Steel
500577	SC60/62-BG	2 1/4"	5/16"	4	Steel



No. SC-85 or SC-85-C with No. SC-87 Insulator



No. SC-85-T Clip

CROCODILE CLIPS (Long)

SKU NO	MFG NO	PK	TYPE
500623	SC85-BG With Insulators	4	Steel
500626	SC85/87BG	2&2	Steel



SC-27C

GENERAL PURPOSE TEST CLIPS

SKU NO	MFG NO	LENGTH	JAW OPEN	PK	TYPE
500629	SC45-BG	1 1/2"	5/8"	2	Steel
500632	SC48B-BG	2"	1/2"	2	Steel
500638	SC27-BG	2 7/16"	5/8"	2	Steel
500641	SC55-BG	2"	7/16"	4	Steel

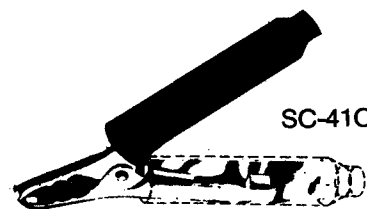

SC-41C

BATTERY BOOSTER CLIP

SKU NO	MFG NO	JAW OPEN	TYPE
500647	SC41-BG	1 1/8"	Copper

7



WIRING DEVICES

Bakelite Flat Handle Cap

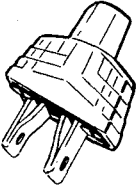

SKU NUMBER 500085
 MFG NUMBER 105
 500090 105M

Flat Connector

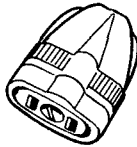

SKU NUMBER 500095
 MFG NUMBER 116

Rubber Handle Attachment Cap

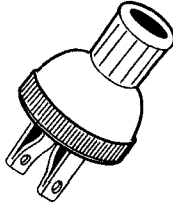

SKU NUMBER 500290
 MFG NUMBER 117

Rubber Cube Tap

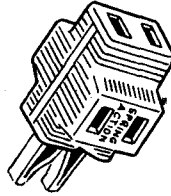

SKU NUMBER 500305
 MFG NUMBER 135

Flat Vinyl Attachment Cap

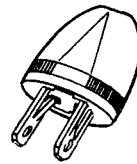

SKU NUMBER 510305
 MFG NUMBER 240

Enclosed Polarized Flat Handle Cap Plastic

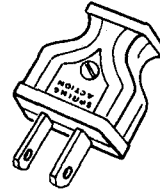

SKU NUMBER 510350
 MFG NUMBER 566
 510355 566I

Rubber Attachment Cap

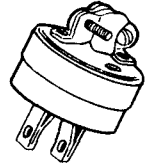

SKU NUMBER 510300
 MFG NUMBER 172

Parallel Polarized Rubber Connector



SKU NUMBER 500310
 MFG NUMBER 170

Parallel Ground Rubber Cap W/Cord Clamp

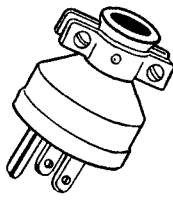

SKU NUMBER 510320
 MFG NUMBER 333-C

Parallel Ground Rubber Connector

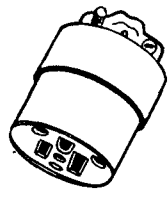

SKU NUMBER 510325
 MFG NUMBER 370

Parallel Ground Rubber Connector

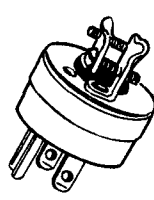

SKU NUMBER 510330
 MFG NUMBER 373

Dead Front Grounding Plugs

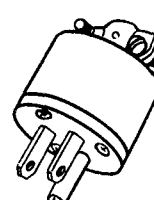

SKU NUMBER 510335
 MFG NUMBER 400

Dead Front Grounding Plugs

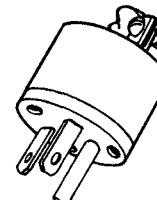

SKU NUMBER 510260
 MFG NUMBER 433

Enclosed Dead Front W/Cord Clamp

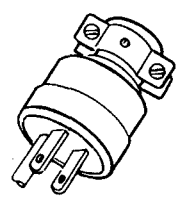

SKU NUMBER 510345
 MFG NUMBER 477-C

academy

7

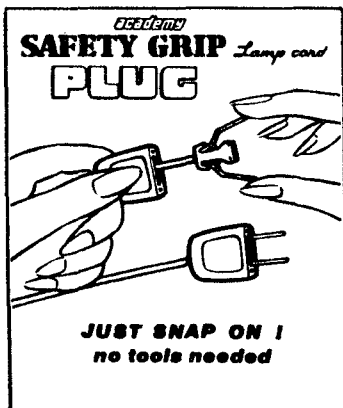

SAFETY GRIP PLUG

HAS FINGER GUARD AND FINGER GRIP. FOR LAMP CORD.

SKU No.	Mfg. No.	Color
500267	220	White
500268	225	Brown
2/CARD		
500269	1222	White
500227	1225	Brown

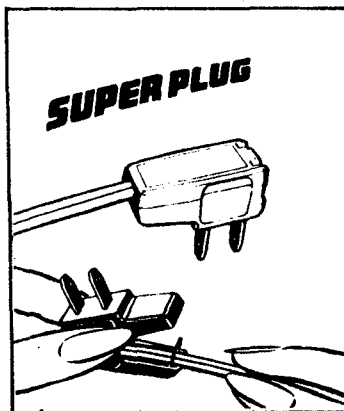

SUPER PLUG

FITS REGULAR OR HEAVY DUTY FLAT WIRE

SKU No.	Mfg. No.	Size
500274	250	White
500276	255	Brown

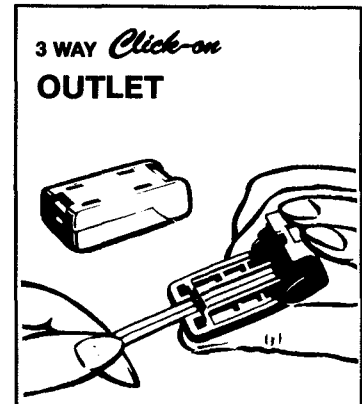

3 WAY CLICK-ON OUTLET

(CUBE END) 3 WAY OUTLET FOR END OF WIRE. FOR LAMP CORD.

SKU No.	Mfg. No.	Size
500272	500	White
500273	505	Brown



**Grounding Surface
 Receptacle 3-Wire
 Nema 6.50 50A-250V**

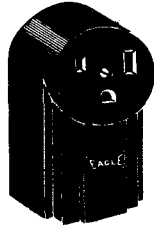

SKU # 511270 MFG # 1252

**Armored
 Grounding Connector
 15A-250V**

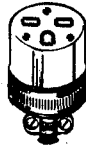

Yellow Vinyl W/Cord Clamp



SKU # 510225 6-15R MFG # 2227B

**Enclosed Tandem
 Grounding Armored Cap**



Yellow Vinyl W/Renouable Cord Clamp



SKU # 510340 6-15P MFG # 2866

**Armored Cap
 3-Wire W/Cord Clamp
 15A-125V**



SKU # 510285 MFG # 863

**STRAIGHT THERMOPLASTIC
 PLUG
 15 AMP, 120V**



COLOR # SKU # MFG #
 BLACK 505799 SA399
 ORANGE 505797 SA399-O

**Enclosed Grounding
 Armored Cap
 Yellow Vinyl 20-125V**



SKU # 510240 MFG # 2809

**Armored Grounding
 Connector 20A-125V**



Yellow Vinyl W/Cord Clamp

5-20R

SKU # 510245 MFG # 2228

**Armored Grounding
 Connector 20A-250V**



Yellow Vinyl W/Cord Clamp

6-20R

SKU # 510265 MFG # 2229

With Removable Cord Clamp Insert

**Angle Heavy
 Duty Cap Black
 Rubber Nema 10-30
 30A-125V**



SKU # 511220 MFG # 80

**Travel Trailer
 Cap 30A-125V**

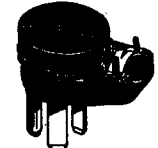

ANSI C73-13
 SKU # 512350 MFG # 83

**Flush Receptacle
 Travel Trailer
 30A-125V W/Plate**

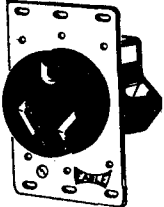

SKU # 512355 MFG # 1263B

**BROWN 2 CIRCUIT
 PLUG**



SKU # 500271 MFG # BP2611B-SP

**Receptacle Body
 Nema 60A-4 Wire
 125/250V Flush**

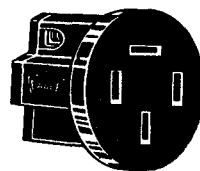

SKU # 511310 MFG # 60
 511330 59-120V

**Armored
 Grounding Connector
 15A-125V**

Yellow Vinyl W/Cord Clamp

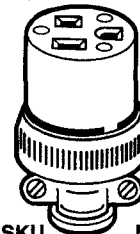

SKU # 510380 MFG # 2887

**Grounding Armored
 Cap Enclosed Parallel**

Yellow Vinyl W/Removable Cord Clamp Insert

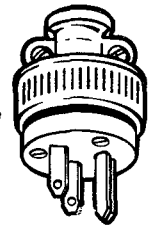

SKU # 510385 MFG # 2867

**Parallel Grounding
 Adapter 2 Pole 2 Wire
 To 3 Pole 3 Wire**

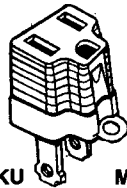

SKU # 511040 MFG # 419GV

**Ground Adapter
 2 Pole 3-Wire**

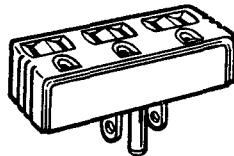

SKU # 507735 MFG # 1147B
 507740 1147V

**Snapin Midget
 Grounding Outlet
 3-Wire 15A-125V**

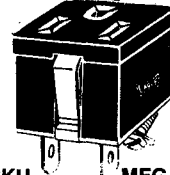

SKU # 512875 MFG # 49-2W

**Angle Cap
 Nema 18-60P
 60A-120V**

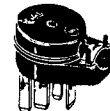

18-60P
 SKU # 511325 MFG # 19

**Eagelok Armored
 Connector Bakelite
 2-Wire Nema 20V**

W/Removable Cord Clamp Insert



L2-20R
 SKU # 511390 MFG # 894

**Eagelok Armored
 Cap 2-Wire Nema 20P
 20A-250V**

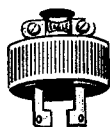

L2-20P
 SKU # 511385 MFG # 874

**Rubber Handle
 Straight Blade Cap
 Nema 5-15**



5-15P
 SKU # 510375 MFG # 1709

**Ground Tap
 2-Pole 3-Wire
 Nema 5-15**

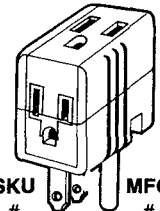

SKU # 507725 MFG # 1482-B
 507730 1482-V



RIBBED PLASTIC WALLPLATE



Ribbed design. Matching mounting screws included.

SKU NO.	Cat. NO.	
504830	3914	BROWN
504960	3914-I	IVORY

DOUBLE GANG DECORA® WALLPLATE

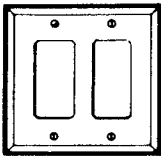

Easy to clean plastic wallplates. Designed exclusively for use with Decora switches and outlets. Decora wallplates can be used interchangeably with switch or outlet.

SKU NO.	Cat. NO.	
504910	80409	BROWN
504800	80409-I	IVORY

SINGLE GANG DECORA® WALLPLATE

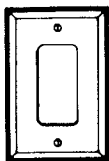

Easy to clean plastic wallplates. Designed exclusively for use with Decora switches and outlets. Decora wallplates can be used interchangeably with switch or outlet.

SKU NO.	Cat. NO.	
504870	80401	BROWN
505000	80401-I	IVORY

3-WAY DECORA® SWITCH
Rating: 15A-120/277V AC
PUSH-IN

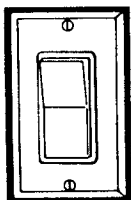

Replaces any standard 3-way wall switch. Rocker switch provides smooth, quiet operation. Comes complete with matching or contrasting frame plus matching wallplate and mounting screws. Controls one fixture

from two separate locations.

SKU NO.	Cat. NO.	
506295	5623	BROWN
506300	5623-I	IVORY

GROUNDING OUTLET
Rating: 15A-125V



Heavy duty, Specification Grade. Terminal screws accept up to No. 10 conductors.

SKU NO.	Cat. NO.	
511135	5015	BROWN
511140	5015-I	IVORY

GROUNDING OUTLET
Rating: 15A-125V



Side wired and push-in wiring. Terminal screws accept up to No. 10 conductors. Break-off fins for two-circuit conversion.

SKU NO.	Cat. NO.	
511085	5320	BROWN
511090	5320-I	IVORY

20 AMP DUPLEX GROUNDING OUTLET
RATING: 15A-250V



Heavy duty, Specification Grade. Terminal screws accept up to No. 10 conductors. Outlet has break-off fins for two-circuit conversion.

SKU NO.	Cat. NO.	
511125	5842	BROWN
511130	5842-I	IVORY

GROUNDING POWER OUTLET
Rating: 20A-250V
DUPLEX



Heavy duty, Specification Grade. Terminal screws accept up to No. 10 conductor.

SKU NO.	Cat. NO.	
511105	5822	BROWN
511110-I	5822-I	IVORY



Our catalog does not contain everything in our inventory. If there are products you do not find that are related to those in this catalog call 437-1205 so that we may assist you.



OUTLET DUPLEX
RATING: 250V

Heavy duty side wire grounding

SKU NO.	Cat. No.	
511095	5028	BROWN

GROUNDING DECORA® OUTLET
Rating: 15A-125V



Replaces any standard duplex outlet. Designed to match Decora® switches.

SKU NO.	Cat NO.	
512215	5325	BROWN
512220	5325-I	IVORY

TRIPLE BLOCK SURFACE OUTLET (IVORY)



Triple block outlet for end of wire

SKU NO.	CAT NO.
510370	67-I

SINGLE GANG WALLPLATE SHIELD

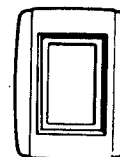

Covers wall area around switches to protect wall finish. Easy to clean. Fits under any switch wallplate.

SKU NO.	Cat. NO.	
505776	801-12795	IVORY
505776	801-12795	CLEAR

Straight Blade Devices - Hard Use, Specification and Standard Grade

15A, 125 & 250V; 20A., 125 & 250V.

Duplex Receptacles

Rating		NEMA Config. No.	Description	SKU NO.	Brown	SKU NO.	Ivory	SKU NO.	White
Amps	Volts, AC								
15	125	5-15R	*Duplex, Steel Strap Duplex, Receptacle	505548	3232	505551	3232-I	890052	3232W
15	125	50-15R							

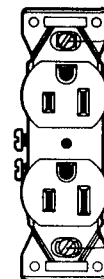

Pass & Seymour
LEGRAND

Straight Blade Devices - 3-Wire, Specification Grade

For Replacement Only

20A., 125/250V. 3-Pole 3-Wire Not Grounding

Single Receptacles, Side and Back Wired

Rating		NEMA Config. No.	Description	SKU NO.	Catalog Number
Amps	Volts, AC				
20	125/250	10-20R	Receptacle, Black Side and Back Wired	510290	6810



NEMA 5-15R Receptacle



NEMA 10-20R Receptacle



Multiple Outlet Strips & Plug-In Units

15A, 125V. AC

The Gard Plus® Power Strips

Rating	Description	SKU NO.	Catalog Numbers
Volts			
125	6-Outlet, circuit breaker protected with spike and noise filter	505696	MOS-6SNP

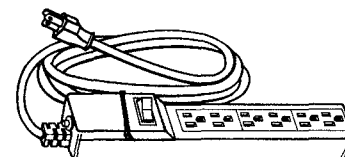

7

Straight Blade Devices - Hospital Grade

15 & 20A., 125 & 250V.

Hospital Grade Duplex Receptacles

Duplex, Side and Back Wired

Rating		NEMA Config. No.	Description	SKU NO.	Catalog Number
Amps	Volts				
15	125	5-15R	*Brown	500030	9200-HGI



NEMA 5-15R Receptacle



NEMA 5-15P Plug

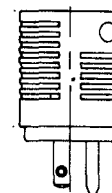

Plugs & Connectors

Rating		NEMA Config. No.	Description	SKU NO.	Catalog Number
Amps	Volts, AC				
15	125	5-15P	Plug	510200	5266-HXG
15	125	5-15P	Plug, Angle 4-Position	510195	5266-HG-AN
15	125	5-15C	Connector	510205	5269-XHG
15	125	5-15P	Plug	510202	5266-X

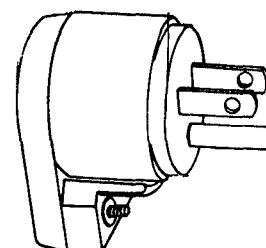

Straight Blade Devices - Extra Hard Use Specification Grade

15 & 20A, 125 - 250V.



5262 Series Receptacles

Single Receptacles, Side and Back Wired

Rating		NEMA Config. No.	Description	SKU NO.	Catalog Number
Amps	Volts, AC				
15	250	6-15R	*Single, Ivory	500005	5671I
20	250	6-20R	*Single, Ivory	500015	587I
15	250	6-15R	Single, Brown	500000	5671B
20	250	6-20R	Single, Brown	500010	587B



NEMA 5-15R Receptacle



NEMA 6-20R Receptacle

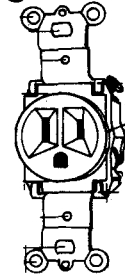

Straight Blade Devices - Hard Use and Commercial Grade

15 & 20A, 125 & 250V.

Duplex Receptacles - Hard Use Specification

Side and Back Wire, Self-Grounding

Rating		NEMA Config. No.	Description	SKU NO.	Brown	SKU NO.	Ivory
Amps	Volts, AC						
15	125	5-15R	*Duplex	511072	5252	511067	5252-I



NEMA 5-15R Receptacle



NEMA 6-15R Receptacle



NEMA 5-20R Receptacle

Hard Use, Side-Wired Only, Self-Grounding

15	125	5-15R	*Duplex	511065	5242	511070	5242-I
15	125/250	5/6-15R	*Duplex, Combination	511115	5290	511120	5290-I

Commercial Specification Grade

Duplex Receptacles, Side-Wired, Self-Grounding

20	125	5-20R	*Duplex, Self-Grounding	511055	5350-S	511060	5350-SI
----	-----	-------	-------------------------	--------	--------	--------	---------

Single Receptacles, Side-Wired

Rating		NEMA Config. No.	Description	SKU NO.	Brown	SKU NO.	Ivory
Amps	Volts, AC						
20	125	5-20R	*Single	511145	5351	511150	5351-I

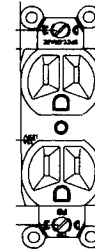

7

Plugs, Inlets & Outlets, Connectors

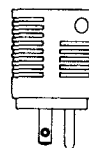

Plug

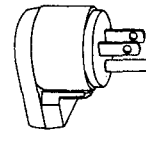

Angle Plug

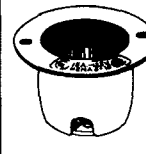

Flanged Inlet

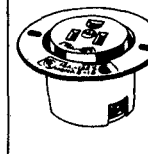

Flanged Outlet

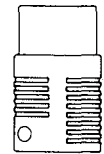

Connector

Rating		Plug Configuration & NEMA	2-Pole 3-Wire Grounding				
Amps	Volts, AC		SKU NO. MFG. NO.	SKU NO. MFG. NO.	SKU NO. MFG. NO.	SKU NO. MFG. NO.	SKU NO. MFG. NO.
15A	125V	5-15P	510390 NSY	510410 5266-SS-AN	510185 5278-SS	510190 5279-SS	510395 5269NS4
15A	125V	6-15P	510210 5666-X	510215 5666-SS-AN			510220 5669-X
15A	125V	5-20P	510230 5366-X				510235 5369-X
15A	125V	6-20P	510250 5466-X				510255 5469-X

2-Wire 15A., 125V.

Turnlok® Midget Connectors, Inlet, Outlet & Plug



Connectors

Rating		NEMA Config. No.	Description	Cord Diameter	SKU NO.	Catalog Number
Amps	Volts, AC					
15	125	ML-1R	Connector with Cord Grip	.218"-.312"	511340	7464

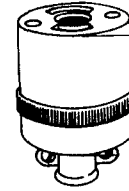

Inlet & Outlet

Rating	NEMA Config. No.	Description	Cord Diameter	SKU NO.	Catalog Number
15 125	ML-1R	Outlet	—	511345	7468

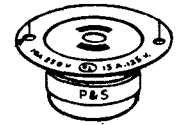

Plug

Rating	NEMA Config. No.	Description	Cord Diameter	SKU NO.	Catalog Number
15 125	ML-1P	Yellow, with Cord Grip	.100"-.350"	511335	7464-DF



NEMA ML-2R Receptacle

7468

3-Wire Grounding 15A., 125V.

Turnlok® Midget Connectors, Inlet, Outlet & Plugs

Connectors

Rating		NEMA Config. No.	Description	Cord Diameter	SKU NO.	Catalog Number
Amps	Volts, AC					
15	125	ML-2R	Brown Plastic, Connector	.218"-.421"	511405	★7593

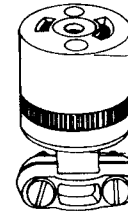

7593-SF

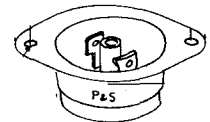

7595

Inlet & Outlet

Rating	NEMA Config. No.	Description	Cord Diameter	SKU NO.	Catalog Number
15 125	ML-2P	Inlet	—	511415	7595



NEMA ML-3R Receptacle

3-Wire Not Grounding 15A., 125/250V.

Turnlok® Midget Connectors, Inlet, Outlet & Plugs

Connectors

Rating		NEMA Config. No.	Description	Cord Diameter	SKU NO.	Catalog Number
Amps	Volts, AC					
15	125/250	ML-3R	Brown Plastic, Connector	.218"-.421"	511565	★7484

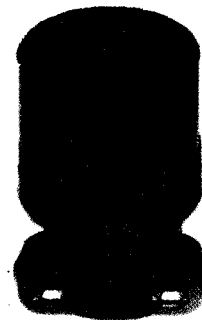

7484-SF

Inlet & Outlet

Rating	NEMA Config. No.	Description	Cord Diameter	SKU NO.	Catalog Number
15 125/250	ML-3R	Outlet	—	511575	7487



7487

Plugs

Rating	NEMA Config. No.	Description	Cord Diameter	SKU NO.	Catalog Number
15 125/250	ML-3P	Brown Plastic Plug	.281"-.421"	511560	★7486-SF



NEMA ML-1R Receptacle



Straight Blade & Turnlok® Protective Boots

Protective Boots

Description	SKU NO	*Catalog Number
Black Boot for 15 & 20A. straight blade, 15A. Locking Connectors	510400	L15-RBC
Black Boot for 15 & 20A. straight blade, 15A. Locking Plugs	510405	L15-RBP



L15-RBP

L15-RBC

Pass & Seymour
L1 legrand

2-Wire 15A., 125V.

Turnlok® Receptacle, Connector, Outlet & Plug

Outlet

Rating		NEMA Config. No.	Description	SKU NO.	Catalog Number
Amps	Volts, AC				
15	125		Outlet	511370	7526

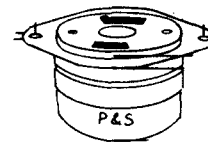

2-Wire 20A., 250V.

Turnlok® Receptacle, Connector & Plug

Connector

Rating		NEMA Config. No.	Description	Cord Diameter	SKU NO.	Catalog Number
Amps	Volts, AC					
20	250	L2-20R	Armored	.296"-.625"	511390	★7101



Plug

Rating	Volts, AC	NEMA Config. No.	Description	Cord Diameter	SKU NO.	Catalog Number
20	250	L2-20P	Armored, Non-Polarized	.296"-.625"	511385	★7102

3-Wire Not Grounding 15A., 125V.; 10A., 250V.

Turnlok® Receptacles, Connector, Inlet, Outlet & Plug

Receptacles

Ampere Rating		Description	Cord Diameter	SKU NO.	Catalog Number
125 Volts	125 Volts				
15	10	Single	—	511605	★7582
15	10	Duplex	—	511600	★7580

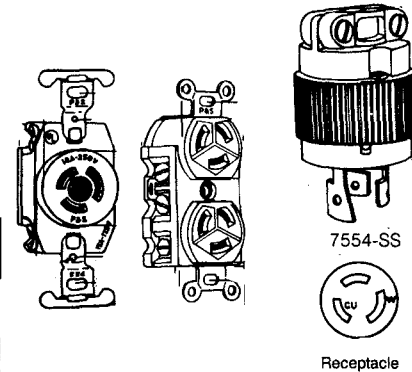

Inlet & Outlet

Rating	Volts	Description	Cord Diameter	SKU NO.	Catalog Number
15	10	Flanged Inlet	—	511595	★7556-SS
15	10	Flanged Outlet	—	511590	★7557-SS

Plug

Rating	Volts	Description	Cord Diameter	SKU NO.	Catalog Number
15	10	Yellow High Impact Insulating Cord Grip	.269"-.625"	511580	★7554-SS

3-Wire Not Grounding 20A., 125/250V.

Turnlok® Receptacles, Connectors & Plugs

Receptacles

Rating	Description	SKU NO.	Catalog Number
125/250	Single Receptacle	511640	★7310

Connectors

Rating	Description	Cord Diameter	SKU NO.	Catalog Number
125/250	Yellow High Impact, with Insulating Cord Grip	.562"-1.062"	511625	7313-SS

Plugs

Rating	Description	Cord Diameter	SKU NO.	Catalog Number
125/250	Yellow High Impact, with Insulating Cord Grip	.562"-1.062"	511620	7311-SS

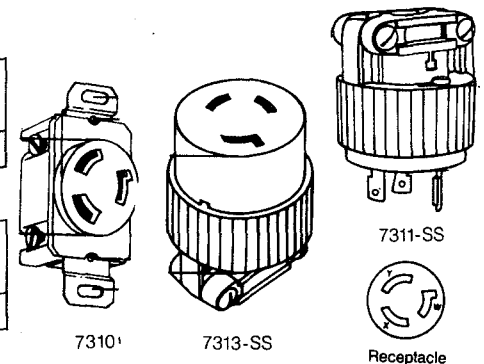

4-Wire Grounding 50A., 600V. AC & 250V. DC

3-Pole 4-Wire With Equipment Ground



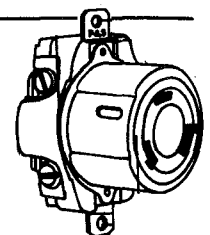

7379 Receptacle

Rating		Description	Cord Diameter	SKU NO.	Catalog Number
Amps	Volts, AC				
50	600V. AC 250V. DC	Outlet	—	512020	7379









Turnlok®
 Specification Grade Locking Devices





Pass & Seymour
legrand®

Plugs, Inlets & Outlets, Connectors, Receptacles						
		Connector	Flanged Inlet	Flanged Outlet	Plug	Receptacle
Rating Amps Volts, AC		Receptacle Configuration & NEMA Number				

2-Pole 3-Wire Grounding

15A	125V		L5-15	SKU NO.	511425	511435	511430	511420	511445
				MFG. NO.	L515-C	4716-SS	4715-SS	L515-T	4710
				SKU NO.					511440
				MFG. NO.					Duplex 4700
20A	125V		L5-20	SKU NO.	511475	511485		511470	511480
				MFG. NO.	L520-C	L520-FI		L520-P	L520-R
15A	250V		L6-15	SKU NO.	511455				511485
				MFG. NO.	L615-C				4560
				SKU NO.					511460
				MFG. NO.					Duplex 4550
20A	250V		L6-20	SKU NO.	511500	511510	511515	511495	511505
				MFG. NO.	L620-C	L620-FI	L620-FO	L620-P	L620-R
30A	125V		L5-30	SKU NO.	511525	511535		511520	511530
				MFG. NO.	L530-C	L530-FI		L530-P	L530-R
30A	250V		L6-30	SKU NO.	511550			511545	511555
				MFG. NO.	L630-C			L630-P	L630-R

3-Pole 3-Wire Not Grounding

















20A	125/250V		L10-20	SKU NO.	511650			511645	511655
				MFG. NO.	L1020-C			L1020-P	L1020-R
20A	125/250V			SKU NO.	511625			511620	511640
				MFG. NO.	7313-SS			7311-SS	7310
20A	3φ /250V		L11-20	SKU NO.	511665			511660	511670
				MFG. NO.	L1120-C			L1120-P	L1120-R
30A	125/250V			SKU NO.	511680			511675	511685
				MFG. NO.	3333-SS			3331-SS	3330

7

Straight Blade Devices - Specification Grade

Power Outlets and Plugs - 20, 30, 50 & 60A.





Rating		Receptacle Configuration & NEMA Number	   			
Amps	Volts, AC		Flush Receptacle	Surface Receptacle	Plug	Connector
2-Pole 3-Wire Grounding						
30A	125V	 5-30	SKU NO. 511195 MFG. NO. 3802		511190 5921	512400 6716N
30A	250V	 6-30	SKU NO. 511205 MFG. NO. 3801		511200 5931	512405 6700N
50A	125V	 5-50	SKU NO. 511255 MFG. NO. 3803			512395 6711N
50A	250V	 6-50	SKU NO. 511265 MFG. NO. 3804		511260 5951	
3-Pole 3-Wire Not Grounding						
30A	125/250V	 10-30	SKU NO. 511210 MFG. NO. 3860	511215 388		
50A	125/250V	 10-50	SKU NO. 511275 MFG. NO. 3890	511280 385	512435 4524N	512430 4526N
Rating		Receptacle Configuration & NEMA Number	   			
Amps	Volts, AC		Flush Receptacle	Surface Receptacle	Plug	Angle Plug
3-Pole 4-Wire Grounding						
20A	125/125V	 14-20	SKU NO. 511160 MFG. NO. 3820		511165 5333-DF	
20A	30 / 250V	 15-20	SKU NO. 511175 MFG. NO. 5833-DF			
30A	125/125V	 14-30	SKU NO. 511230 MFG. NO. 3864	511235 3884		511225 3867



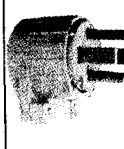

7

Straight Blade Devices - Specification Grade

20, 30, 50 & 60A.

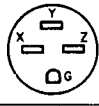
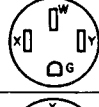
<p>Flush Receptacles, Wall Plates, Surface Receptacles, Plugs and Angle Plugs</p>		 <p>Flush Receptacle</p>	 <p>Plug</p>	 <p>Angle Plug</p>	
					<table border="1"> <tr> <th colspan="2">Rating</th> <th rowspan="2">Receptacle Configuration & NEMA Number</th> </tr> <tr> <th>Amps</th> <th>Volts, AC</th> </tr> </table>
Rating		Receptacle Configuration & NEMA Number			
Amps	Volts, AC				

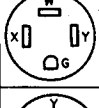
3-Pole 4-Wire Grounding











30A	3 ϕ , 250V	 15-30	SKU NO. MFG. NO.	511245 5740		511240 5741-AN
50A	125/250V	 14-50	SKU NO. MFG. NO.	511290 3894		511285 5745-AN
50A	3 ϕ , 250V	 15-50	SKU NO. MFG. NO.	511300 5750		511295 5751-AN
60A	125/250V	 14-60	SKU NO. MFG. NO.			
60A	3 ϕ , 250V	 15-60	SKU NO. MFG. NO.	511320 5760		

4-Pole 4-Wire Not Grounding

3 ϕ Y, 120/208V	 18-20	SKU NO. MFG. NO.	511180 3822	511185 7251-DF	
----------------------	--	---------------------	----------------	-------------------	--

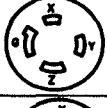
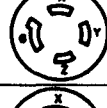
Our catalog does not contain everything in our inventory. If there are products you do not find that are related to those in this catalog call 437-1288 so that we may assist you.

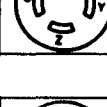
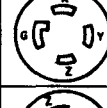

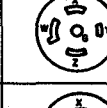
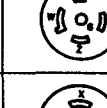
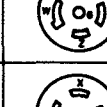
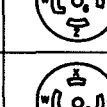
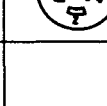
Pass & Seymour Legrand® Plugs, Inlets & Outlets, Connectors, Receptacles		 Connector	 Flanged Inlet	 Flanged Outlet	 Plug	 Receptacle		
Rating		Receptacle Configuration & NEMA Number	Turnlok® Specification Grade Locking Devices					
Amps	Volts, AC							
3-Pole 4-Wire Grounding								
20A	125/125V	 L14-20	SKU NO. MFG. NO.	511895 L4120-C		511890 L1420-P	511700 L1420-R	
20A	3φ /250V	 L15-20	SKU NO. MFG. NO.	511710 L1520-C		511705 L1520-P	511715 L1520-R	
20A	3φ /480V	 L16-20	SKU NO. MFG. NO.	511725 L1620-C		511720 L1620-P	511730 L1620-R	
30A	125/250V	 L14-30	SKU NO. MFG. NO.	511740 L1430-C		511735 L1430-P	511745 L1430-R	
30A	3φ /250V	 L15-30	SKU NO. MFG. NO.	511805 L1530		511800 L1530-P	511810 L1530-R	
30A	3φ Y, 408V	 L16-30	SKU NO. MFG. NO.	511820 L1630-C		511815 L1630-P	511825 L1630-R	
4-Pole 4-Wire Not Grounding								
20A	3φ Y, 120/208V	 7413-SS	SKU NO. MFG. NO.	511845 7413-SS	511850 7408-SS	511855 7409-SS	511835 7411-SS	511860 7410
30A	3φ Y, 120/208V	 3433-SS	SKU NO. MFG. NO.	511870 3433-SS		511865 3431-SS	511875 3430	
4-Pole 5-Wire Grounding								
20A	3φ Y, 120/208V	 L21-20	SKU NO. MFG. NO.	511885 L2120-C		511880 L2120-P	511890 L2120-R	
20A	3φ Y, 227/408V	 L22-20	SKU NO. MFG. NO.	511900 L2220-C			511905 L2220-R	
20A	3φ Y, 347/600V	 L23-20	SKU NO. MFG. NO.			511910 L2320-P		
30A	3φ 120/208V	 L21-30	SKU NO. MFG. NO.	511930 L2130-C		511925 L2130-P	511935 L2130-R	
30A	3φ Y, 227/480V	 L22-30	SKU NO. MFG. NO.	511945 L2230-C		511940 L2230-P	511950 L2230-R	

7

Ground Fault Circuit Interrupter Receptacles

Standard & Specification Grade 15 & 20A, 120V.

Standard Grade

Push-In Back and Side Wired Duplex

Rating			Description	SKU NO.	NEMA Config.	Catalog Number
Amps	Feed-Thru Amps	Volts, AC				
15	20	120	Feed-Thru, Brown	500035	5-15R	1591-R
15	20	120	Feed-Thru, Ivory	500040	5-15R	1591-RI
15	20	120	Feed-Thru, White	500091	5-15R	1591-RW

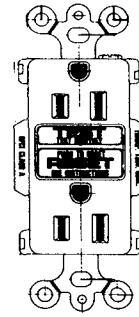

Pass & Seymour
legrand®

Ground Fault Circuit Interrupters

Hospital Grade Receptacles, Switch/Motor Control & GFCI Plugs

GFCI Switch/Motor Control

Rating		Description	SKU NO.	Catalog Number
Amps	Volts, AC			
20	120	GFCI, Switch/Motor Control, Ivory, with Screw Terminals	506415	2081-SI

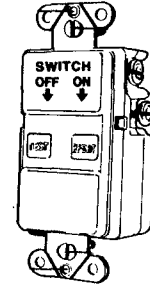

Ground Fault Circuit Interrupters

Portables & Accessories

Portable 15 & 20A. GFCI's

Portable/20

Description	Catalog Number	SKU NO.	Configuration Receptacle Plug
20A, 125V. straight blade (NEMA 5-20R) outlets. has 20A, 125V. (NEMA 5-20P) plug.	PS200-S	500434	

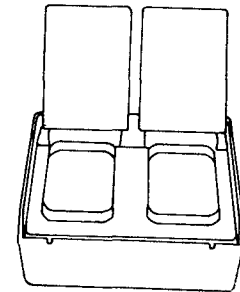

Isolated Ground Receptacles

Isolated Ground Receptacles Back & Side Wire

Rating		NEMA Config. No.	Description	SKU NO.	Catalog Number
Amps	Volts, AC				
20	125	5-20R	Duplex	500020	IG6300
20	125	5-50R	Single	500025	IG5361

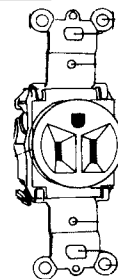

Special Purpose Devices – Despard®

Interchangeable Switches, Receptacles, Pilot Lights, 15 & 20A, 120/125 - 277V. AC

Toggle Switches

Screw Terminals

Rating		Handle Type	SKU NO.	Single Pole	SKU NO.	Three Way
Amps	Volts, AC					
15	120-277	Brown	506205	ACD1	506220	ACD3-I
15	120-277	Ivory	506210	ACD1-I		

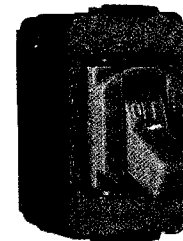

ACD1

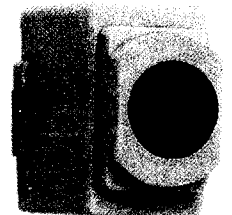

1475

Pilot Lights

Flush Neon with Screw Terminals

Rating		Description	SKU NO.	Brown	SKU NO.	Ivory
W.	V.					
1/25	125	Flush Neon Pilot Light			512925	1475

Manual Controllers

15, 20 & 30A, 120-277V. AC — Maintained Contact; 15, 20 & 30A, 120-277V. AC — Momentary Contact



1221 Series: Maintained

Maintained Contact Three Position—Two Circuit, Center Off

Rating		Description	SKU NO.	S.P.D.T.	SKU NO.	D.P.D.T.
Amps	Volts, AC					
20	120-277	Brown Toggle*	506145	1225	506150	1226

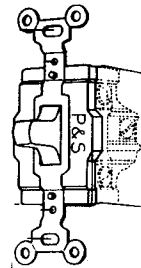

1250 Series: Momentary

Momentary Contact Either Direction Three Position, Center Off

Rating		Description	SKU NO.	S.P.D.T.	SKU NO.	D.P.D.T.
Amps	Volts, AC					
20	120-277	Brown Toggle*	506165	1251		
30	120-277	Brown Toggle*	506155	1255		

Features

- Oversize silver alloy contacts for long life and better heat dissipation.
- Side-wired terminals accept #14 to #10 AWG copper or copper-clad conductors.
- Fiber terminal insulation barriers standard.
- Can be mounted in standard device boxes or in NEMA 1 sheet steel enclosures.
- Bodies, covers and toggles molded of arc-resistant Urea.
- Single Pole—Double Throw and Double Pole—Double Throw.

Application

For ON-OFF control of motors on small machine tools, pumps, fans and air conditioning equipment that require heavy-duty AC Double Throw Center OFF controls.

Lock Switch Keys

Description	SKU NO.	CAT. NO.
For devices made prior to 1976	506040	1498
For current devices	506035	1498-NT

Manual Controllers

20 & 30A. 1φ, 15A. 3φ ON/OFF Motor Switches; 15 & 30A. Explosion-Proof

ON/OFF Motor Switches

Application

For ON-OFF control of single and 3-phase motors on small machine tools, pumps, fans and resistance heater loads. No overload protection.

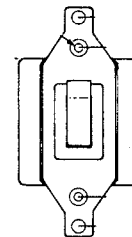

Features

- Oversize silver contacts for long life and better heat dissipation.
- Single phase switches are side wired with #14 - #10 AWG copper or copper-clad conductors.
- Three phase controls are side wired for #14 - #12 AWG copper or copper-clad conductors.
- Can be mounted in standard 2-1/8" utility or switch box. For surface mounting use No. 7806 NEMA 1 sheet steel enclosure with No. 7801 handle guard.

Double Pole, Three Phase

Rating		Description	SKU NO.	Catalog Numbers
Amps	HP Volts			
Amp. 600	Volts Max. 3φ HP (Max.)	Switch only for Three Phase motor and heater loads	506130	7803
3 @ 240 Volts		(7803 Switch in NEMA 1 Enclosure)	506135	7813
2 @ 480 Volts				

SENIOR QUIETTE, CORBIN LOCK TYPE

BINDING SCREW TYPE, FOR BACK SIDE WIRING

Two keys are supplied with each lock switch. HH41 key is standard. Key removable in the "ON" and "OFF" position. Standard finish of lock dome is nickel.

DESCRIPTION	CAT. NO.
Single Pole	1181

NOTES:

- AC switches are not recommended for use on Master or Emergency Power Systems.
- Safety ground clip provided on all senior quiette switches.
- AC switches can be used on H.P. applications as permitted by N.E.C. paragraphs 430-83 and 430-109.
- H.P. CONVERSION DATA (applies to 277VAC switches only): 15 AMPS, 1/2 H.P. 120VAC, 2 H.P. 240VAC

SKU NO. 505758

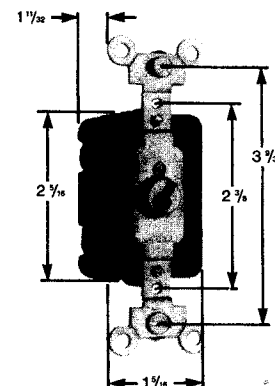

1181

Specification Grade AC Switches

15, 20 & 30A; 120-277V. AC

Pass & Seymour
Legrand

Lock Switches

Rating		Toggle Color	SKU NO.	Single Pole	SKU NO.	Double Pole
Amps	Volts, AC					
20	120-277	Gray	506245	20AC1-L	506330	20AC2-L

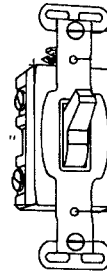

Features

- Quiet featherweight toggle action.
- Speedwire (push wiring) or Screw terminal (side wiring).
- Extra long mounting screws.
- Extra heavy plated strap.
- Contacts fully enclosed in compact body.
- Shallow design.

Standard Switches

Rating		Toggle Color	SKU NO.	Single Pole	SKU NO.	Double Pole	SKU NO.	Three Way	SKU NO.	Four Way
Amps	Volts, AC									
15	120-277	Brown	506455	15AC1	506305	15AC2				
11	120-277	Ivory	506456	15AC1-I	506310	15AC2-I				
20	120-277	Brown	506235	20AC1	506320	20AC2	506285	20AC3	506115	20AC4
20	120-277	Ivory	506240	20AC1-I	506325	20AC2-I	506290	20AC3-I	506120	20AC4-I
30	120-277	Brown	506250	30AC1	506335	30AC2				
30	120-277	Ivory			506340	30AC2-I				
15	120-277	White					506457	15AC3-W		

Commercial Specification Grade AC Switches

15 & 120-277V. AC

Application

The 501 Series can be used at full rated capacity on tungsten filament, fluorescent and H.I.D. lighting loads and on motor loads to 277V. at 80% of rated amperage. 501 Series is recommended for general application in commercial, light industrial and institutional installations.

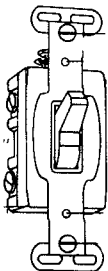

AC Switches

Rating		Toggle Color	SKU NO.	Single Pole	SKU NO.	Four Way
Amps	Volts, AC					
15	120-277	Brown	506420	501	506345	504
15	120-277	Ivory	506425	501-I		

AC Switches

15 & 120-277V. AC

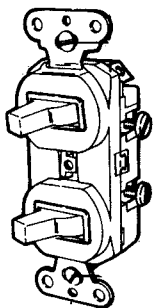

Combination Devices Switches

Rating		Description	SKU NO.	Brown	SKU NO.	Ivory
Amps	Volts, AC					
15	120-277	*Two Single Pole Switches	506575	690		
15	120-277	*Two Single Pole Switches, Grounded			506580	690-G
15	120-277	*Single Pole and Three Way	506375	696	506380	696-I
15	120-277	*Two Three Way Switches			506400	693-I

Switch With Receptacle

Rating	Description	SKU NO.	Brown	SKU NO.	Ivory	
15	120	*Single Pole with NEMA 5-15R Receptacle	506355	691	506360	691-I
15	125					

Switch With Pilot Light

Rating	Description	SKU NO.	Brown	SKU NO.	Ivory	
15	120	*Single Pole with Pilot Light	506565	692	506570	692-I
25W	125					

Standard Grade AC Switches

15 & 120V.

Features

- Easily accessible break-off for separate or common feed.
- Long-life red neon lamp in pilot light rated 1/25 Watt, 120V.
- Side-wired terminals accept #14 to #10 AWG copper or copper-clad conductors.

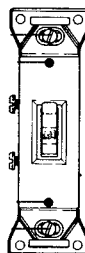





Standard Grade 660 Series

Rating AC only		Toggle Color	SKU NO.	Single Pole
Amps	Volts, AC			
15	120	Brown	506100	660
15	120	Ivory	506105	660-I

DUPLEX GCFI RECEPTACLES—TRADEMASTER®

RATING		DESCRIPTION	SKU NO.	NEMA Config.	Catalog Number
AMPS	VOLTS, AC				
20	125	Feed-Thru, Ivory Feed-Thru, White	500045	5-20R	2091-I
20	125		500039	5-20R	2091-W



DEAD FRONT PLUGS & CONNECTORS			 PLUG	 CONNECTOR
RATING	Receptacle Configuration & NEMA Number			
AMPS	VOLTS, AC		SKU NO.	MFG. NO.
15	125/125v	 5-15P	507794	5276 BK
15	125/125v	 5-15R	507797	5296 BK

Special Purpose Devices – Despard®
 Mounting Straps

Mounting Straps

Description	Screw Spacing	SKU NO.	Catalog Number
Appliance Strap	1-31/32"	506190	1354



BOX CONNECTOR DUST TIGHT INSULATED THROAT

SKU NO.	CATALOG NUMBER	FITTING SIZE	CABLE DIAMETER RANGE
511861	BOX40	1/2	.40-.54
511862	BOX52	3/4	.52-.73



Special Purpose Devices – Tomic® Fittings
 Connectors & Accessories

Box Holder Assembly

SKU NO.	Cat. No.	Description	Size
512353	90	Complete Assembly	5/16" x 4"

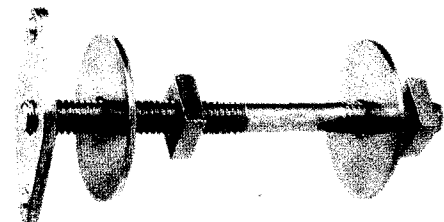

7