



NYLON INSULATED
WITH INSUL. SUPPORT



VINYL INSULATED
FUNNEL ENTRY



NON-INSULATED
BUTTED SEAM



NON-INSULATED
BRAZED SEAM

RING TONGUE TERMINALS

| SKU NO. | PART NO. | DESCRIPTION | WIRE RANGE | STUD SIZE | PIECES PER PKG. | SKU NO. | PART NO. | DESCRIPTION | WIRE RANGE | STUD SIZE | PIECES PER PKG. |
|---------|----------|-----------------|------------|-----------|-----------------|---------|----------|---------------|------------|-----------|-----------------|
| 508041 | 13000 | Vinyl Insulated | 22-18 | 6 | 10 | | | | | | |
| 508030 | 13000 | Funnel Entry | 22-18 | 6 | 100 | 508410 | 11004 | Butted Seam | 16-14 | 6 | 100 |
| 508044 | 13001 | Vinyl Insulated | 22-18 | 8 | 10 | | | | | | |
| 508035 | 13001 | Funnel Entry | 22-18 | 8 | 100 | 508415 | 11005 | Butted Seam | 16-14 | 8 | 100 |
| 508047 | 13002 | Vinyl Insulated | 22-18 | 10 | 10 | | | | | | |
| 508040 | 13002 | Funnel Entry | 22-18 | 10 | 100 | 508420 | 11006 | Butted Seam | 16-14 | 10 | 100 |
| 508054 | 13004 | Vinyl Insulated | 16-14 | 6 | 10 | 508277 | 11007 | Non-Insulated | 16-14 | 1/4" | 10 |
| 508050 | 13004 | Funnel Entry | 16-14 | 6 | 100 | 508425 | 11007 | Butted Seam | 16-14 | 1/4" | 100 |
| 508057 | 13005 | Vinyl Insulated | 16-14 | 8 | 10 | 508281 | 11013 | Non-Insulated | 12-10 | 1/4" | 10 |
| 508055 | 13005 | Funnel Entry | 16-14 | 8 | 100 | 508288 | 11013 | Butted Seam | 12-10 | 1/4" | 100 |
| | | | | | | | | | | | |
| 508060 | 13006 | Funnel Entry | 16-14 | 10 | 100 | 508390 | 11033 | Butted Seam | 22-18 | 5-6 | 100 |
| 508064 | 13007 | Vinyl Insulated | 16-14 | 1/4" | 10 | 508036 | 12001 | Non-Insulated | 8 | 1/4" | 5 |
| 508065 | 13007 | Funnel Entry | 16-14 | 1/4" | 100 | 508550 | 12001 | Brazed Seam | 8 | 1/4" | 25 |
| 508067 | 13008 | Vinyl Insulated | 16-14 | 5/16" | 10 | | | | | | |
| 508070 | 13008 | Funnel Entry | 16-14 | 5/16" | 100 | 508555 | 12002 | Brazed Seam | 8 | 3/8" | 25 |
| 508071 | 13009 | Vinyl Insulated | 16-14 | 3/8" | 10 | 508087 | 12003 | Non-Insulated | 8 | 1/2" | 5 |
| 508075 | 13009 | Funnel Entry | 16-14 | 3/8" | 100 | 508560 | 12003 | Brazed Seam | 8 | 1/2" | 25 |
| | | | | | | | | | | | |
| 508085 | 13011 | Funnel Entry | 12-10 | 8 | 100 | 508572 | 12005 | Non-Insulated | 6 | 1/4" | 1 |
| 508077 | 13012 | Vinyl Insulated | 12-10 | 10 | 10 | 508576 | 12006 | Non-Insulated | 6 | 1/4" | 1 |
| 508090 | 13012 | Funnel Entry | 12-10 | 10 | 100 | 508582 | 12007 | Non-Insulated | 6 | 1/2" | 1 |
| 508080 | 13013 | Vinyl Insulated | 12-10 | 1/4" | 10 | 508591 | 12010 | Non-Insulated | 4 | 1/4" | 1 |
| 508095 | 13013 | Funnel Entry | 12-10 | 1/4" | 100 | 508956 | 12011 | Non-Insulated | 4 | 3/8" | 1 |
| | | | | | | 508604 | 12012 | Non-Insulated | 4 | 1/2" | 1 |
| | | | | | | 508605 | 12012 | Brazed Seam | 2 | 1/4" | 1 |
| 508100 | 13014 | Funnel Entry | 12-10 | 5/16" | 100 | 508603 | 12015 | Non-Insulated | 2 | 1/4" | 10 |
| 508086 | 13015 | Vinyl Insulated | 12-10 | 3/8" | 10 | 508607 | 12016 | Non-Insulated | 2 | 3/8" | 1 |
| 508105 | 13015 | Funnel Entry | 12-10 | 3/8" | 100 | 508611 | 12017 | Non-Insulated | 2 | 1/2" | 1 |
| 508089 | 13016 | Vinyl Insulated | 12-10 | 1/2" | 10 | 508616 | 12021 | Non-Insulated | 1/6 | 3/8" | 1 |
| 508110 | 13016 | Funnel Entry | 12-10 | 1/2" | 100 | 508623 | 12022 | Non-Insulated | 1/6 | 1/2" | 1 |
| | | | | | | 508627 | 12025 | Non-Insulated | 3/6 | 3/8" | 1 |
| | | | | | | 508631 | 12026 | Non-Insulated | 3/6 | 1/2" | 1 |
| 508051 | 13034 | Vinyl Insulated | 16-14 | 5-6 | 10 | 508636 | 12032 | Non-Insulated | 3/6 | 3/8" | 1 |
| 508045 | 13034 | Funnel Entry | 16-14 | 5-6 | 100 | 508642 | 12033 | Non-Insulated | 3/6 | 1/2" | 1 |
| 508257 | 11000 | Non-Insulated | 22-18 | 6 | 10 | | | | | | |
| 508395 | 11000 | Butted Seam | 22-18 | 6 | 100 | 508650 | 12036 | Non-Insulated | 3/6 | 3/8" | 1 |
| 508261 | 11001 | Non-Insulated | 22-18 | 8 | 10 | 508655 | 12037 | Non-Insulated | 3/6 | 1/2" | 1 |
| 508400 | 11001 | Butted Seam | 22-18 | 8 | 100 | | | | | | |
| 508264 | 11002 | Non-Insulated | 22-18 | 10 | 10 | | | | | | |
| 508405 | 11002 | Butted Seam | 22-18 | 10 | 100 | | | | | | |

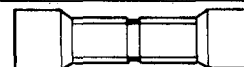

DOUBLE FEMALE RECEPTACLES

| SKU NO. | PART NO. | NEMA PIN DIA. | PIECES PER PKG. |
|---------|----------|---------------|-----------------|
| 508199 | 15083 | .157 | 5 |
| 508285 | 15083 | .157 | 30 |

7

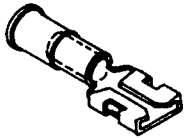

VINYL INSULATED FUNNEL ENTRY

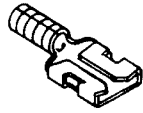

NON-INSULATED BUTTED SEAM

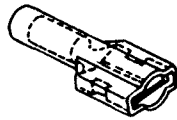

NYLON INSULATED FUNNEL ENTRY

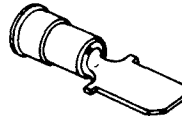

VINYL INSULATED FUNNEL

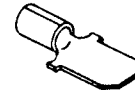

NON-INSULATED BUTTED SEAM

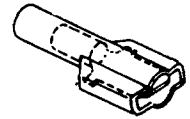

NYLON INSULATED FUNNEL ENTRY

FEMALE DISCONNECTS

| SKU NO. | PART NO. | DESCRIPTION | WIRE RANGE | TAB SIZE | PIECES PER PKG. |
|---------|-----------|-----------------|------------|----------|-----------------|
| 508311 | SO-1125SF | Non-insulated | 16-14 | .110 | 10 |
| 508525 | 11095 | Butted Seam | 22-18 | .187 | 100 |
| 508342 | 11096 | Non-insulated | 22-18 | .250 | 100 |
| 508530 | 11096 | Butted Seam | 22-18 | .250 | 100 |
| 508346 | 11098 | Non-insulated | 16-14 | .250 | 10 |
| 508535 | 11098 | Butted Seam | 16-14 | .250 | 100 |
| 508314 | SO-9382SF | Non-insulated | 16-14 | .110 | 10 |
| 508540 | 11099 | Butted Seam | 12-10 | .250 | 100 |
| 508177 | 13096 | Vinyl Insulated | 22-18 | .250 | 10 |
| 508250 | 13096 | Funnel Entry | 22-18 | .250 | 100 |
| 508255 | 13097 | Funnel Entry | 16-14 | .250 | 100 |
| 508184 | 13098 | Vinyl Insulated | 16-14 | .250 | 10 |
| 508260 | 13098 | Funnel Entry | 16-14 | .250 | 100 |
| 508187 | 13099 | Vinyl Insulated | 12-10 | .250 | 10 |
| 508265 | 13099 | Funnel Entry | 12-10 | .250 | 100 |
| 508212 | 15102 | Nylon Insulated | 22-18 | .250 | 5 |
| 508305 | 15102 | Funnel Entry | 22-18 | .250 | 50 |
| 508310 | 15104 | Funnel Entry | 16-14 | .250 | 50 |
| 508315 | 15107 | Funnel Entry | 12-10 | .250 | 50 |

MALE DISCONNECTS

| SKU NO. | PART NO. | DESCRIPTION | WIRE RANGE | TAB SIZE | PIECES PER PKG. |
|---------|----------|------------------|------------|----------|-----------------|
| 508326 | 11085 | Non-insulated | 22-18 | .187 | 10 |
| 508505 | 11085 | Butted Seam | 22-18 | .187 | 100 |
| 508329 | 11086 | Non-insulated | 22-18 | .250 | 10 |
| 508510 | 11086 | Butted Seam | 22-18 | .250 | 100 |
| 508485 | SO-982SF | Non-insulated | 16-14 | .110 | 10 |
| 508332 | 11088 | Non-insulated | 16-14 | .250 | 10 |
| 508515 | 11088 | Butted Seam | 16-14 | .250 | 100 |
| 508336 | 11089 | Non-insulated | 12-10 | .250 | 10 |
| 508520 | 11089 | Butted Seam | 12-10 | .250 | 100 |
| 508162 | 13086 | Vinyl Insulated | 22-18 | .250 | 10 |
| 508225 | 13086 | Funnel | 22-18 | .250 | 100 |
| 508168 | 13087 | Vinyl Insulated | 16-14 | .187 | 10 |
| 508230 | 13087 | Funnel | 16-14 | .187 | 100 |
| 508171 | 13088 | Vinyl Insulated | 16-14 | .250 | 10 |
| 508235 | 13088 | Funnel | 16-14 | .250 | 100 |
| 508174 | 13089 | Vinyl Insulated | 12-10 | .250 | 10 |
| 508240 | 13089 | Funnel Insulated | 12-10 | .250 | 100 |
| 508202 | 15094 | Nylon Insulated | 16-14 | .250 | 5 |
| 508290 | 15094 | Funnel Entry | 16-14 | .250 | 50 |
| 508206 | 15090 | Nylon Insulated | 12-10 | .250 | 5 |
| 508295 | 15090 | Funnel Entry | 12-10 | .250 | 50 |



Non-Insulated Butted Seam



MALE-FEMALE ADAPTERS

| SKU NO. | PART NO. | DESCRIPTION | TAB SIZE | PIECES PER PKG. |
|---------|----------|----------------|----------|-----------------|
| 508365 | 11216 | Stacking 3 Way | .250 | 50 |

FLAG FEMALE DISCONNECTS

| SKU NO. | PART NO. | DESCRIPTION | WIRE RANGE | TAB SIZE | PIECES PER PKG. |
|---------|----------|---------------|------------|----------|-----------------|
| 508242 | 11204 | Non-Insulated | 16-14 | .250 | 10 |
| 508370 | 11204 | Butted Seam | 16-14 | .250 | 100 |

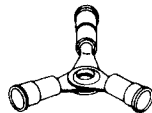

VINYL INSULATED 3 WAY CONNECTORS

| SKU NO. | PART NO. | WIRE RANGE | PIECES PER PKG. |
|---------|----------|------------|-----------------|
| 508236 | 13062 | 16-14 | 5 |
| 508340 | 13062 | 16-14 | 25 |
| 508204 | 13064 | 12-10 | 5 |
| 508345 | 13064 | 12-10 | 25 |



CLOSED END CONNECTORS

| SKU NO. | PART NO. | WIRE RANGE | PIECES PER PKG. |
|---------|----------|------------|-----------------|
| 508248 | 15105 | 22-18 | 5 |
| 508380 | 15105 | 22-18 | 50 |
| 508251 | 15106 | 16-14 | 5 |
| 508385 | 15106 | 16-14 | 50 |

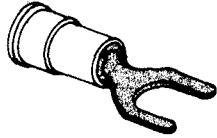

VINYL INSULATED
FUNNEL ENTRY



NON-INSULATED
BUTTED SEAM

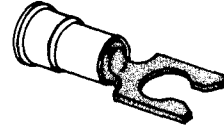

VINYL INSULATED
FUNNEL ENTRY

SPADE TONGUE TERMINALS

| SKU NO. | PART NO. | DESCRIPTION | WIRE RANGE | STUD SIZE | PIECES PER PKG. |
|---------|----------|-----------------|------------|-----------|-----------------|
| 508284 | 11040 | Non-insulated | 22-18 | 6 | 10 |
| 508435 | 11040 | Butted Seam | 22-18 | 6 | 100 |
| 508287 | 11041 | Non-insulated | 22-18 | 8 | 10 |
| 508440 | 11041 | Butted Seam | 22-18 | 8 | 100 |
| 508445 | 11042 | Butted Seam | 22-18 | 10 | 100 |
| 508450 | 11047 | Butted Seam | 16-14 | 6 | 100 |
| 508455 | 11048 | Butted Seam | 16-14 | 8 | 100 |
| 508299 | 11049 | Non-insulated | 16-14 | 10 | 10 |
| 508460 | 11049 | Butted Seam | 16-14 | 10 | 100 |
| 508302 | 11054 | Non-insulated | 12-10 | 6 | 10 |
| 508470 | 11054 | Butted Seam | 12-10 | 6 | 100 |
| 508306 | 11056 | Non-insulated | 12-10 | 8 | 10 |
| 508475 | 11056 | Butted Seam | 12-10 | 8 | 100 |
| 508092 | 13040 | Vinyl Insulated | 22-18 | 6 | 10 |
| 508115 | 13040 | Funnel Entry | 22-18 | 6 | 100 |
| 508096 | 13041 | Vinyl Insulated | 22-18 | 8 | 10 |
| 508120 | 13041 | Funnel Entry | 22-18 | 8 | 100 |
| 508099 | 13042 | Vinyl Insulated | 22-18 | 10 | 10 |
| 508125 | 13042 | Funnel Entry | 22-18 | 10 | 100 |
| 508102 | 13047 | Vinyl Insulated | 16-14 | 6 | 10 |
| 508130 | 13047 | Funnel Entry | 16-14 | 6 | 100 |
| 508106 | 13048 | Vinyl Insulated | 16-14 | 8 | 10 |
| 508140 | 13049 | Funnel Entry | 16-14 | 10 | 100 |
| 508145 | 13054 | Funnel Entry | 12-10 | 6 | 100 |
| 508150 | 13055 | Funnel Entry | 12-10 | 8 | 100 |
| 508121 | 13056 | Vinyl Insulated | 12-10 | 10 | 10 |
| 508155 | 13056 | Funnel Entry | 12-10 | 10 | 100 |

LOCKING SPADE TERMINALS

| SKU NO. | PART NO. | DESCRIPTION | WIRE RANGE | STUD SIZE | PIECES PER PKG. |
|---------|----------|-----------------|------------|-----------|-----------------|
| 508123 | 13140 | Vinyl Insulated | 22-18 | 6 | 10 |
| 508160 | 13140 | Funnel Entry | 22-18 | 6 | 100 |
| 508126 | 13141 | Vinyl Insulated | 22-18 | 8 | 10 |
| 508165 | 13141 | Funnel Entry | 22-18 | 8 | 100 |
| 508132 | 13147 | Vinyl Insulated | 16-14 | 6 | 10 |
| 508175 | 13147 | Funnel Entry | 16-14 | 6 | 100 |
| 508180 | 13148 | Funnel Entry | 16-14 | 8 | 100 |
| 508139 | 13149 | Vinyl Insulated | 16-14 | 10 | 10 |



VINYL INSULATED
FUNNEL ENTRY



NON-INSULATED
BUTTED SEAM

HOOK TONGUE TERMINALS

| SKU NO. | PART NO. | DESCRIPTION | WIRE RANGE | STUD SIZE | PIECES PER PKG. |
|---------|----------|-----------------|------------|-----------|-----------------|
| 500133 | 11071 | Butted Seam | 16-14 | 10 | 100 |
| 500032 | 13066 | Funnel Entry | 22-18 | 6 | 100 |
| 508142 | 13068 | Vinyl Insulated | 22-18 | 10 | 10 |
| 508190 | 13068 | Funnel Entry | 22-18 | 10 | 100 |
| 508239 | 13069 | Vinyl Insulated | 16-14 | 6 | 10 |
| 508146 | 13071 | Vinyl Insulated | 16-14 | 10 | 10 |
| 508195 | 13071 | Funnel Entry | 16-14 | 10 | 100 |
| 508149 | 13074 | Vinyl Insulated | 12-10 | 10 | 10 |

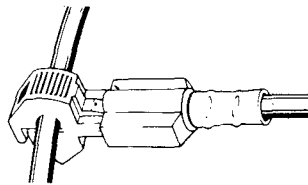

T-TAP CONNECTORS

| SKU NO. | PART NO. | WIRE RANGE | PIECES PER PKG. |
|---------|----------|------------|-----------------|
| 508226 | 13310 | 16-14 | 5 |
| 508325 | 13310 | 16-14 | 50 |



BONDED PARALLEL WIRE

| SKU NO. | PART NO. | WIRE GA | SPOOLS |
|---------|----------|---------|---------|
| 144TRA | W-10144 | 14 | 100 ft. |
| 164TRA | W-10164 | 14 | 100 ft. |





UN-INSULATED
BRAZED SEAM



VINYL INSULATED
BUTTED SEAM



UN INSULATED
FLARED-SEAMLESS

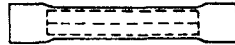

NON-INSULATED
BUTTED SEAM

BUTT SPLICE CONNECTORS

| SKU NO. | PART NO. | DESCRIPTION | WIRE RANGE | PIECES PER PKG. |
|---------|----------|-----------------|------------|-----------------|
| 508317 | 11026 | Non-insulated | 22-18 | 10 |
| 508490 | 11026 | Butted Seam | 22-18 | 100 |
| 508321 | 11027 | Non-insulated | 16-14 | 10 |
| 508500 | 11028 | Butted Seam | 12-10 | 100 |
| 508152 | 13026 | Vinyl Insulated | 22-18 | 10 |
| 508205 | 13026 | Butted Seam | 22-18 | 100 |
| 508156 | 13027 | Vinyl Insulated | 16-14 | 10 |
| 508210 | 13027 | Butted Seam | 16-14 | 100 |
| 508159 | 13028 | Vinyl Insulated | 12-10 | 10 |
| 508215 | 13028 | Butted Seam | 12-10 | 100 |
| 508058 | 12029 | Un-insulated | 8 | 5 |
| 508545 | 12029 | Brazed Seam | 8 | 25 |
| 508567 | 12030 | Un-insulated | 6 | 1 |
| 508587 | 12031 | Un-insulated | 4 | 1 |
| 500124 | 14024 | Un-insulated | 2 | 1 |
| 500127 | 14025 | Un-insulated | 1 | 1 |
| 500227 | 14026 | Un-insulated | 1/0 | 1 |
| 500128 | 14027 | Un-insulated | 2/0 | 1 |
| 500033 | 14028 | Un-insulated | 3/0 | 1 |
| 500031 | 14029 | Un-insulated | 4/0 | 1 |

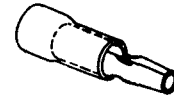

MALE SNAP PLUGS & FEMALE RECEPTACLES

| SKU NO. | PART NO. | DESCRIPTION | WIRE RANGE | NEMA PIN DIA. | PIECES PER PKG. |
|---------|----------|-----------------|------------|---------------|-----------------|
| 508191 | 13075 | Vinyl Insulated | 16-14 | .157 | 10 |
| 508270 | 13075 | Vinyl Insulated | 16-14 | .157 | 100 |
| 508196 | 15078 | Nylon Insulated | 16-14 | .157 | 5 |
| 508280 | 15078 | Nylon Insulated | 16-14 | .157 | 50 |

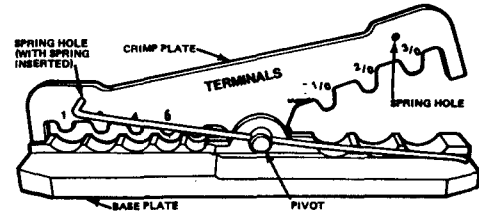

CRIMP TOOL

| SKU NO. | PART NO. |
|---------|----------|
| 500335 | 14202 |

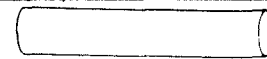

SK830 UL Listed UF Splice Kit

- 14 to 8 gauge copper wire rated to 600V.
- For direct underground burial of UF wire.
- Includes 4 conductor splice connector.
- Includes the UL listed shrink tubing required for application.
- Unit is the FIRST UL listed Splice Kit for direct underground burial UF type wire.

SKU NO. 501100

SOLDERLESS TERMINAL KITS



SKU NUMBER 505007

MFG NUMBER 89976

Description 158-piece assortment of single-grip, insulated terminals in compartmented plastic box.

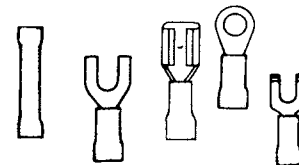

158-Piece Insulated-Terminal Kit

Contains 15 assorted single-grip insulated terminal styles for a wide variety of general-purpose applications such as electrical, automotive, refrigeration, air conditioning and appliance repairs; radio, TV, Hi-Fi and electronics work, and other general maintenance and repair work. Includes 158 total terminals of the following: 61205, 61210, 61305, 61310, 61410, 61414, 63206, 63210, 63306, 63310, 67202, 67302, 67402, 68301, 68302. Kit is made of sturdy see-thru plastic with 15 compartments, one for each terminal style. Measures 8 3/4" L x 4" W x 1" D (222 x 102 x 25 mm).

HI-TEMP TERMINALS AND CONNECTORS

TEMPERATURE RATINGS:

CONTINUOUS:

900 DEG. F, 482 DEG. C.

INTERMITTANT:

1200 DEG. F, 649 DEG. C.



RING TONGUE

| SKU NO. | PART NO. | WIRE RANGE | STUD SIZE | WIDTH "W" | CLEARANCE | PIECES PER PKG. |
|---------|----------|------------|-----------|-----------|-----------|-----------------|
| 501102 | 19000 | 22-18 | 5-6 | .25 | .22 | 10 |
| 500008 | 19000 | 22-18 | 5-6 | .25 | .22 | 100 |
| 501105 | 19002 | AWG | 10 | .33 | .29 | 10 |
| 500009 | 19002 | AWG | 10 | .33 | .29 | 100 |
| 501108 | 19004 | 16-14 | 5-6 | .25 | .22 | 10 |
| 500011 | 19004 | 16-14 | 5-6 | .25 | .22 | 100 |
| 508002 | 19006 | AWG | 10 | .33 | .29 | 10 |
| 500012 | 19006 | AWG | 10 | .33 | .29 | 100 |
| 508012 | 19012 | 12-10 | 10 | .38 | .29 | 10 |
| 500013 | 19012 | 12-10 | 10 | .38 | .29 | 100 |
| 508011 | 19013 | AWG | ¼ | .61 | .44 | 10 |
| 500014 | 19013 | AWG | ¼ | .61 | .44 | 100 |



FLAG STYLE

| SKU NO. | PART NO. | WIRE RANGE | NEMA TAB SIZE | PIECES PER PKG. |
|---------|----------|------------|---------------|-----------------|
| 508027 | 19204 | 16-14 | .250x.032 | 10 |
| 500021 | 19204 | 16-14 | .250x.032 | 100 |

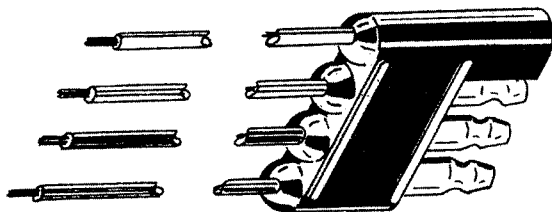

TRAILER WIRING CONNECTORS

| SKU NO. | PART NO. | DESCRIPTION | PIECES PER PKG. |
|---------|----------|-----------------------|-----------------|
| 508665 | 2128 | Three male—one female | 10 |



BUTT SPLICE

| SKU NO. | PART NO. | WIRE RANGE | PIECES PER PKG. |
|---------|----------|------------|-----------------|
| 508014 | 19026 | 22-18 | 10 |
| 500016 | 19026 | 22-18 | 100 |
| 508017 | 19027 | 16-14 | 10 |
| 500017 | 19027 | 16-14 | 100 |
| 508021 | 19028 | 12-10 | 10 |
| 500018 | 19028 | 12-10 | 100 |

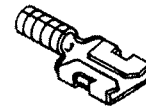

FEMALE DISCONNECT

| SKU NO. | PART NO. | WIRE RANGE | NEMA TAB SIZE | PIECES PER PKG. |
|---------|----------|------------|---------------|-----------------|
| 508352 | 19097 | 16-14 | .187x.020 | 10 |
| 520000 | 19097 | 16-14 | .187x.020 | 100 |
| 508024 | 19098 | AWG | .250x.032 | 10 |
| 500019 | 19098 | AWG | .250x.032 | 100 |

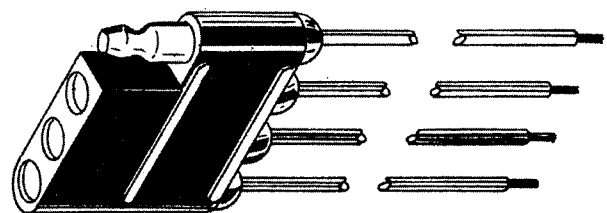

TRAILER WIRING CONNECTORS

| SKU NO. | PART NO. | DESCRIPTION | PIECES PER PKG. |
|---------|----------|-----------------------|-----------------|
| 508670 | 2129 | Three female—one male | 10 |

TERMINAL STRIP



SKU NO.
507790

CAT NO.
34231

7

before shrinking



after shrinking



CROSSLINKED IRRADIATED POLYOLEFIN

| SKU NO. | PART NO. | DESCRIPTION | DIAMETER | SHRINKS TO | PIECES PER PKG. |
|---------|----------|------------------|-------------|------------|-----------------|
| 509405 | 13798 | Heat Shrink Tube | 1/8" x 6" | 1/16" | 16 |
| 509410 | 13799 | Heat Shrink Tube | 3/16" x 6" | 3/32" | 12 |
| 509415 | 13800 | Heat Shrink Tube | 1/4" x 6" | 1/8" | 10 |
| 509420 | 13801 | Heat Shrink Tube | 3/8" x 6" | 3/16" | 6 |
| 500007 | 13802 | Heat Shrink Tube | 1/2" x 6" | 1/4" | 4 |
| 509425 | 13803 | Heat Shrink Tube | 3/4" x 6" | 3/8" | 3 |
| 509430 | 13804 | Heat Shrink Tube | 1" x 6" | 1/2" | 2 |
| 509435 | 13816 | Heat Shrink Tube | 1/4" x 48" | 1/8" | 1 |
| 509440 | 13817 | Heat Shrink Tube | 3/8" x 48" | 3/16" | 1 |
| 509445 | 13818 | Heat Shrink Tube | 1/2" x 48" | 1/4" | 1 |
| 509986 | 13821 | Heat Shrink Tube | 1/4" x 6" | 3/64" | 10 |
| 509989 | 13822 | Heat Shrink Tube | 3/8" x 6" | 3/32" | 6 |
| 509993 | 13823-B | Heat Shrink Tube | 1/2" x 6" | 3/16" | 4 |
| 509996 | 13824 | Heat Shrink Tube | 3/4" x 6" | 1/4" | 3 |
| 509999 | 13825 | Heat Shrink Tube | 1" x 6" | 3/8" | 2 |
| 500004 | 13828 | Heat Shrink Tube | 1/8" x 48" | 1/16" | 5 |
| 500006 | 13829 | Heat Shrink Tube | 3/16" x 48" | 3/32" | 5 |

TEST CLIP

| SKU NO. | PART NO. | DESCRIPTION | SIZE | AMP |
|---------|-----------|-------------|---------|-----|
| 500502 | SC11-A-BX | Steel | 15/8" | 100 |
| 500523 | SC11-C-BX | Copper | 15/8" | 200 |
| 500508 | SC21-A-BX | Steel | 1 1/16" | 50 |
| 500524 | SC21-C-BX | Copper | 1 1/16" | 100 |
| 500511 | SC24-A-BX | Steel | 3/4" | 25 |
| 500526 | SC25-C-BX | Copper | 3/4" | 75 |
| 500514 | SC27-BX | Steel | 5/8" | 20 |
| 500527 | SC27-C-BX | Copper | 5/8" | 40 |
| 500529 | SC33-C-BX | Copper | 2 1/4" | 300 |
| 500517 | SC48-B-BX | Steel | 1/2" | |
| 500532 | SC48-C-BX | Copper | 1/2" | |
| 500533 | SC51-C-BX | Copper | 1/2" | |

ALLIGATOR CLIPS

| SKU NO. | PART NO. | DESCRIPTION |
|---------|------------|-------------|
| 500577 | SC60/62-BG | Steel |

NYLON CABLE TIES—SELF LOCKING

| SKU NO. | PART NO. | LENGTH | BUNDLE DIAMETER | PIECES PER PKG. | COLOR |
|---------|----------|--------|-----------------|-----------------|---------|
| 501695 | 13701 | 4" | 3/4" | 25 | Natural |
| 501705 | 13702 | 4" | 3/4" | 100 | Natural |
| 501715 | 13703 | 4" | 3/4" | 1000 | Natural |
| 501725 | 13704 | 6" | 1 1/4" | 25 | Natural |
| 501735 | 13705 | 6" | 1 1/4" | 100 | Natural |
| 501745 | 13706 | 6" | 1 1/4" | 1000 | Natural |
| 501755 | 13707 | 5.5" | 1 1/4" | 25 | Natural |
| 501765 | 13708 | 5.5" | 1 1/4" | 100 | Natural |
| 501775 | 13709 | 5.5" | 1 1/4" | 1000 | Natural |
| 501785 | 12710 | 8" | 1 3/4" | 25 | Natural |
| 501795 | 13711 | 8" | 1 3/4" | 100 | Natural |
| 501805 | 13712 | 8" | 1 3/4" | 1000 | Natural |
| 501815 | 13713 | 11" | 2 1/2" | 25 | Natural |
| 501825 | 13714 | 11" | 2 1/2" | 100 | Natural |
| 501835 | 13716 | 15" | 4" | 25 | Natural |
| 501845 | 13717 | 15" | 4" | 100 | Natural |
| 501855 | 13719 | 15" | 4" | 25 | Natural |
| 501865 | 13720 | 15" | 4" | 50 | Natural |
| 501875 | 13732 | 4" | 3/4" | 100 | Black |
| 501885 | 13735 | 6" | 1 1/4" | 100 | Black |
| 501895 | 13738 | 5.5" | 1 1/4" | 100 | Black |
| 501905 | 13741 | 8" | 1 1/4" | 100 | Black |
| 501915 | 13744 | 11" | 2 1/2" | 100 | Black |

MOUNTING BASES

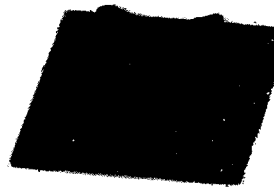

- Use with GB Cable Ties for a strong anchorage for wire and cable bundles. Adhesive-backed with molded screw holes for extra holding power.
- Insert ties from all four sides.
- Durable 6/6 nylon material, with 120 lbs. tensile strength.

| SKU NO. | MFC NO. | SIZE | QUANTITY |
|---------|---------|-------------|----------|
| 512205 | MB-10 | 3/4" x 3/4" | 100 |
| 512210 | MB-20 | 1/8" x 1/8" | 100 |

ADHESIVE APPLIED CABLE TIE MOUNTING BASE

SKU#
505056

MFG#
E13-200C

TIP CLIP

| SKU NO. | PART NO. | DESCRIPTION | SIZE |
|---------|-----------|-------------|-------|
| 500521 | SC85-T-BX | Steel | 5/16" |

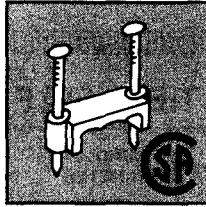

Plastic Insulated Staples

- Heavy plastic, non-corroding, insulated
- Secures UF-non-metallc, BX-copper tubing, TV lead wires
- Stabilized against UV rays and extreme cold
- Adapts to many sizes, plus 3 conductors, portable cords

| SKU NO. | Mfg. No. | Pieces Per Pkg. |
|---------|----------|-----------------|
| 502171 | 2W25 | 25 |
| 502177 | 2W50 | 50 |

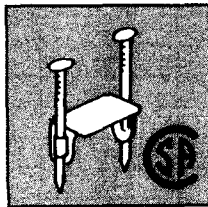

PAL-Straps

- For use with BX-Romex-UF, other non-metallic cables
- All metal, plated to avoid rusting

| SKU NO. | Mfg. No. | Pieces Per Pkg. |
|---------|----------|-----------------|
| 502183 | PS25 | 25 |
| 502189 | PS50 | 50 |

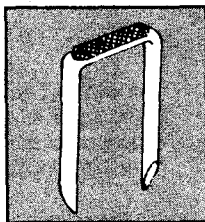

12-Gauge Cable Staples

- For use with BX-Romex-UF, other non-metallic cables
- Carbon steel with no barbs or burrs

| SKU NO. | Mfg. No. | Size | Pieces Per Pkg. |
|---------|----------|-------|-----------------|
| 502261 | CS-11 | 12-14 | 100 |
| 502267 | CS-21 | 10-12 | 100 |

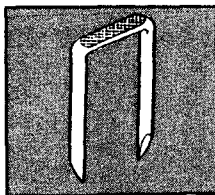

Service Entrance Cable Staples

- Heavy duty construction
- Easy nailing
- Quality carbon steel
- No barbs or burrs

| SKU NO. | Mfg. No. | Size | Pieces Per Pkg. |
|---------|----------|------|-----------------|
| 502273 | CS-31 | 6 | 100 |

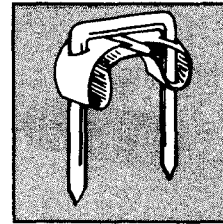

Fiber Insulated Staples

- Sharp pointed, stiff wire to prevent bending
- Locked insulator cannot fall off
- Coppered, brown or white, rust proof
- Secures phone wires, small portable cords, sound system wires, etc.

| SKU NO. | Mfg. No. | Color | Pieces Per Pkg. |
|---------|----------|-------|-----------------|
| 502213 | FI-50B | Brown | 50 |
| 502219 | FI-50W | White | 50 |

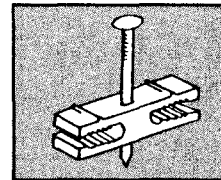

Quick-Mount Staples

- Unbreakable, non-rusting, 2 usable sides
- Secure Christmas light sets, sound system wires, lamp cords, lead wires, etc.

| SKU NO. | Mfg. No. | Pieces Per Pkg. |
|---------|----------|-----------------|
| 502201 | IN25 | 25 |
| 502207 | IN50 | 50 |

SS-11
SS-125

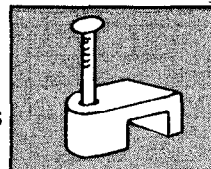

SS-21

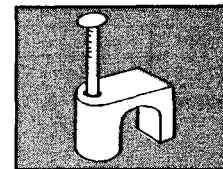

Coaxial Cable and Sound Straps

- Heavy duty plastic with carbon steel, electro-zinc plated nails
- Stabilized against UV rays and extreme cold

| SKU NO. | Mfg. No. | Size | Pieces Per Pkg. |
|---------|----------|---------------|-----------------|
| 502231 | SS-11 | .125" x .200" | 100 |
| 502237 | SS-125 | .125" x .200" | 25 |
| 502243 | SS-21 | .250 | 100 |

POLYPROPYLENE QUICK CLAMP

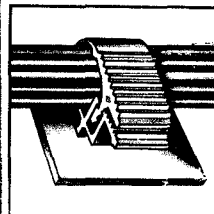

| SKU NO. | MFG. NO. | SIZE |
|---------|----------|-------|
| 505041 | AC1 | 3/16" |
| 505043 | AD1 | 1/4" |
| 505044 | AC1 | 3/8" |
| 505046 | AC1 | 1/2" |
| 505049 | AC1 | 3/4" |



GB WIRE CONNECTORS

WIREGARD™ COLOR-CODED SCREW-ON WIRE CONNECTORS



- Makes quick, secure connections for positive continuity.
- Color-coded for easy size selection.
- Tough, thermoplastic shell shields against environmental extremes.
- Superior flash-over protection.

| SKU NO. | MFC NO. | MODEL NUMBER | COLOR |
|---------|---------|--------------|--------|
| 511010 | 10-001 | 71B | GRAY |
| 511015 | 10-002 | 72B | BLUE |
| 511020 | 10-003 | 73B | ORANGE |
| 511025 | 10-004 | 74B | YELLOW |
| 511030 | 10-006 | 76B | RED |
| 511035 | 10-008 | 78B | GRAY |

PLASTIC KWIK CLIPS

- Mount bundles, cables, cords, tools, ect. to drywall, wood and painted surfaces.
- Ratcheting / Releasable feature allows adjustment to a range of bundle diameters.

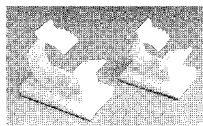

| SKU No. | CATALOG NUMBER | DESCRIPTION | PACKAGE QUANTITY |
|---------|----------------|------------------|------------------|
| 500520 | GKK-1538 | Holds 3/8" Cable | 6/Card |
| 500535 | GKK-1550 | Holds 1/2" Cable | 4/Card |
| 500545 | GKK-1575 | Holds 3/4" Cable | 2/Card |

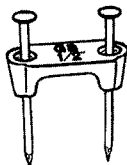

PLASTIC STAPLES

Use with Romex, UF and other type NM Cable up to 3-conductor (#10).

Fast and easy to install — drive both zinc-plated nails together without splitting wood.

Nail heads are recessed for minimum exposure.

| SKU NO. | CATALOG NUMBER | SIZE AND APPLICATION | BAG QUANTITY |
|---------|----------------|-------------------------------|--------------|
| 511775 | PS-75 | 3/4" for 3-conductor (#10 and | 50 |

OX-GUARD™ ANTI-OXIDANT COMPOUND

The perfect safeguard for Al/Al, Al/Cu wire connections and aluminum conduit joints.

- Guards against oxidation
- Improves conductivity; penetrates aluminum oxide to maintain interstrand and inter-conductor current paths.
- Produces a cooler connection.



| SKU NO. | CATALOG NUMBER | SIZE |
|---------|----------------|--------------------|
| 512955 | OX-800 | 8 oz. squeeze tube |



PLASTIC CABLE CLAMPS

Economy and Permanence for Construction, Maintenance and Assembly Line Operations

- Working temperature range: -66° to 340°F

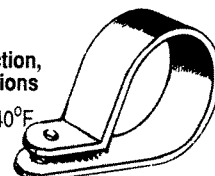

| SKU NO. | CATALOG NUMBER | DIMENSIONS (in.) | | |
|---------|----------------|-------------------|-----------|--------------|
| | | A (Size/Diameter) | E (Width) | BOX QUANTITY |
| 501497 | PPC-1 | 1/8 | 3/8 | 100 |
| 501500 | PPC-2 | 3/16 | 3/8 | 100 |
| 501503 | PPC-3 | 1/4 | 3/8 | 100 |
| 501509 | PPC-5 | 3/8 | 3/8 | 100 |
| 501515 | PPC-7 | 1/2 | 3/8 | 100 |
| 501518 | NCC610 | 5/8 | 1/2 | 100 |
| 501521 | PPC-30 | 3/4 | 1/2 | 100 |
| 501524 | NCC614 | 7/8 | 1/2 | 100 |
| 501527 | PPC-32 | 1 | 1/2 | 100 |
| 501530 | PPC-33 | 1 1/8 | 1/2 | 100 |
| 501533 | PPC-34 | 1 1/4 | 1/2 | 100 |
| 501536 | NCC233 | 1 1/2 | 1/2 | 100 |

PORCELAIN WIRE NUTS

| SKU | MFG# | SIZE |
|--------|--------|--------|
| 505058 | 10-411 | SMALL |
| 505059 | 10-415 | MEDIUM |
| 505061 | 10-417 | LARGE |

ELECTRICAL CONNECTORS

"SCOTCHLOK" Y, R, G AND B ELECTRICAL SPRING CONNECTORS

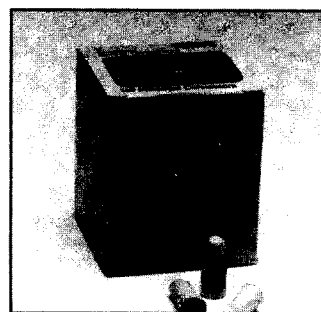

The original color-coded wire connector features three-part construction. Flexible vinyl insulator won't cut or abrade wires. Steel inner shell allows for spring expansion/contraction when exposed to temperature changes. 100% active live spring expands throughout the

connector to put more bite on the wires. Flared design aids wire insertion. For 22-6 AWG conductors.

| SKU No. | UPC Number | Desc. | Cat. No. | Range Wire | Conn. Per Box |
|---|------------|--------|----------|------------|---------------|
| | 054007 | | | | |
| "Scotchlok" Brand Electrical Connectors— Box | | | | | |
| 510960 | 20041 | Yellow | "Y" | 22-10 | 100 |
| 510965 | 20058 | Red | "R" | 18-10 | 100 |
| 510970 | 21346 | Gray | "G" | 14-8 | 100 |
| 510975 | 20066 | Blue | "B" | 12-6 | 50 |

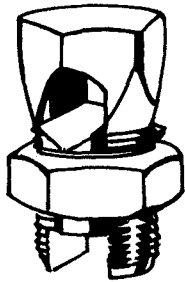

(SPLIT BOLTS) TYPE SB

**FOR COPPER AND
COPPERWELD WIRES**

Service Solderless Connectors are made of High Strength Silicon Bronze. Nuts are 90% Copper, spacer forged copper. Uniform throughout.

Split Bolt Connectors

| SKU NO. | Catalog Number | Max. Wire Equal Run Equal Tap | Min. Tap With Max. Run |
|---------|----------------|-------------------------------|------------------------|
| 503131 | SB 10 | 10 STR | 14 STR |
| 503132 | SB 8 | 8 STR | 14 STR |
| 503133 | SB 6 | 6 STR | 12 STR |
| 503134 | SB 4 | 4 STR | 12 STR |
| 503136 | SB 3 | 2 SOL | 10 STR |
| 503137 | SB 2 | 2 STR | 10 STR |
| 503138 | SB 1/0 | 1/0 STR | 10 STR |
| 503139 | SB 2/0 | 2/0 STR | 10 STR |
| 503141 | SB 3/0 | 3/0 STR | 8 STR |
| 503142 | SB 250 | 4/0-250 MCM | 8 STR |
| 503143 | SB 350 | 350 MCM | 1/0 STR |
| 503144 | SB 500 | 500 MCM | 2/0 STR |
| 503146 | SB 750 | 750 MCM | 4/0 STR |
| 503147 | SB 1000 | 1000 MCM | 4/0 STR |

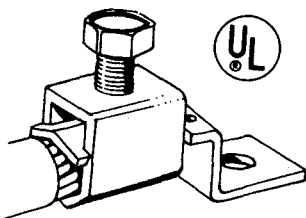

Tang & Collar Lugs – Copper

| SKU NO. | Catalog Number | Wire Range | Rating AMP NEC |
|------------------------|----------------|-----------------|----------------|
| SINGLE TERMINAL | | | |
| 503148 | DE-703 | 10-14 STR | 25 |
| 503149 | DE-704 | 6-14 STR | 35-50 |
| 503151 | DE-705 | 2-8 STR | 70-90 |
| 503152 | DE-706 | 1/0-6 STR | 125 |
| 503153 | DE-707 | 4/0-2 STR | 225 |
| 503154 | DE-708 | 500 MCM-1/0 STR | 400 |
| 503156 | DE-709 | 1000-600 MCM | 650 |

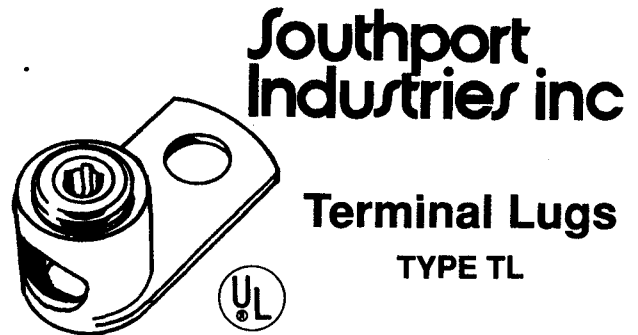

**Southport
Industries inc**

**Terminal Lugs
TYPE TL**

Single Terminal Lugs for Copper Conductor

| SKU NO. | Catalog Number | Ampere Rating | Conductor Range | |
|---------|----------------|---------------|-----------------|---------|
| | | | Max. | Min. |
| 503162 | TL-1 | 35 | 8 STR. | 14 SOL. |
| 503163 | TL-2 | 70 | 4 STR. | 14 SOL. |
| 503164 | TL-3 | 125 | 1/0 STR. | 6 SOL. |
| 503166 | TL-4* | 125 | 1/0 STR. | 6 SOL. |

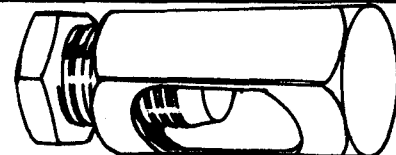

Service Entrance Connectors

**BODY AND SCREW ARE OF HIGH STRENGTH
CORROSION RESISTANT COPPER ALLOY.**

| SKU NO. | Catalog Number | Max. Wire Size |
|---------|----------------|----------------|
|---------|----------------|----------------|

WITHOUT SPACER – NOT PLATED – COPPER TO COPPER

| | | |
|--------|------|--------|
| 503157 | SE-8 | 12 STR |
| 503158 | SE-6 | 6 STR |
| 503159 | SE-4 | 4 STR |
| 503161 | SE-2 | 2 STR |

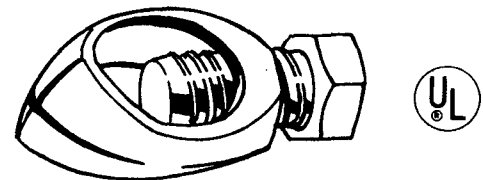

Ground Rod Clamps – Silicon Bronze

| SKU NO. | Catalog Number | Ground Rod Size | Ground Wire Max. |
|---------|----------------|-----------------|------------------|
| 503167 | GC 30 | 1/2" | 2 SOL |
| 503168 | GC 31 | 5/8" | 1/0 SOL |
| 503169 | GC 32 | 3/4" | 2 SOL |

7

Plymouth BISHOP

Premium 111 Grey

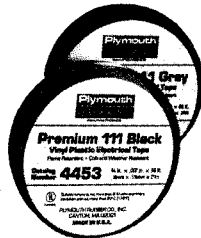

| SKU NO. | MFG. NO. | SIZE |
|---------|----------|------------|
| 500724 | 4472 | 3/4" x 66' |

VINYL PLASTIC ELECTRICAL TAPES

Revere 7

BLACK



| SKU NO. | MFG. NO. | SIZE |
|---------|----------|------------|
| 500001 | 3117 | 3/4" x 66' |

100 ASTM Friction Tape



| SKU NO. | MFG. NO. | SIZE |
|---------|----------|------------|
| 500733 | 1002#8 | 3/4" x 60' |
| 500734 | 1004#4 | 3/4" x 30' |

Premium 37 Color Coding



| SKU NO. | MFG. NO. | ASST COLORS |
|---------|----------|-------------|
| 500727 | 3165 | 1/2" x 20' |

LOW VOLTAGE RUBBER TAPES

122 Rubber Tape Splicing Compound



BLACK

| SKU NO. | MFG. NO. | SIZE |
|---------|----------|------------|
| 500736 | 2002 | 3/4" x 22' |
| 500737 | 2004 | 3/4" x 11' |

125 Electrical Filler Tape

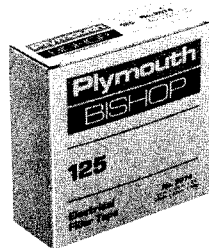

| SKU NO. | MFG. NO. | SIZE |
|---------|----------|--------------|
| 500739 | 2074 | 1 1/2" x 60' |

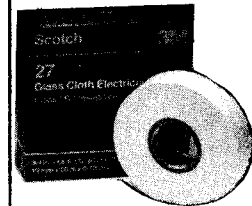

Glass Cloth Electrical Tape 27 Scotch

Is a 7-mil (.18mm) tape with thermosetting, pressure-sensitive adhesive which performs at glass B temperatures. Also provides heat-stable insulation for hot-spot applications.

| SKU NO. | Mfg. No. | Size/Length |
|---------|----------|-------------|
| 510955 | 15066 | 1/2" x 66' |
| 510740 | 15074 | 3/4" x 66' |

7

SCOTCH Vinyl Plastic Electrical Tape No. 35 - for Color Coding

This tape is the electrician's safety tool in a roll. Use it for phase identification, marking of motor leads and piping systems and for outlining safety areas. It is available in red, blue, yellow, green, orange, brown, violet and gray. Specify color.

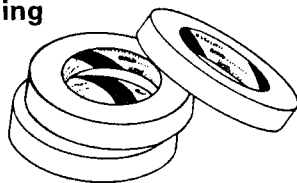

| SKU No. | Mfg. No. | Color | Size |
|---------|----------|--------|------------|
| 510745 | 10810 | Red | 3/4" x 66' |
| 510750 | 10836 | Blue | 3/4" x 66' |
| 510755 | 10844 | Yellow | 3/4" x 66' |
| 510760 | 10828 | White | 3/4" x 66' |
| 510765 | 10851 | Green | 3/4" x 66' |
| 510770 | 10869 | Orange | 3/4" x 66' |
| 510775 | 10885 | Brown | 3/4" x 66' |
| 510780 | 00072 | Grey | 3/4" x 66' |
| 510785 | 11271 | Violet | 3/4" x 66' |

TAPES

SCOTCH Vinyl Plastic Electrical Tape Super 33 Plus

Made of vinyl plastic; has excellent resistance to flame, abrasion, moisture, alkalis, solvents, oil and many acids. Gives full electrical and mechanical protection.



| SKU No. | Mfg. No. | Size | Type |
|---------|----------|------------|------|
| 510940 | 06132 | 3/4" x 66' | #33 |
| 510945 | 06143 | 3/4" x 66' | #88 |

HIGHLAND Vinyl Plastic Electrical Tape

An economically priced tape that is 7 mils thick, tough and stretchy. Each roll cellophane wrapped. U.L. listed.

| SKU No. | Mfg. No. | Size |
|---------|----------|------------|
| 510950 | 16719 | 3/4" x 66' |

Scotch™ Heavy Duty Contact Cleaner



243
 1607 penetrates, cleans and lubricates (contains some silicone). The high-pressure cleaning action of this product quickly and thoroughly removes dust, dirt, grease and oxidation, penetrating the surface pores to leave a fine silicone film to help protect against corrosion. Restores and maintains original electrical values and constants when used as directed on switches and contacts, motor brushes and switches, meter bases, disconnects, solenoids, rheostats, relays and tuners. Inhibits salt-spray corrosion, noise caused by dust and dirt.

| SKU NO. | MFG. NO. | SIZE |
|---------|----------|---------|
| 510663 | 1607 | 20¼ oz. |

DUCT SEAL COMPOUND

- **Temperature Range:** Adheres at -20° F. Will not slump after 1 hr. at 350° F.
- **Flash Point:** Over 550° F
- **Other Properties:** Non-conducting, non-deteriorating, non-toxic, non-corrosive, non-staining, non-curable. 99% solid.



- **Seals conduit openings** against drafts, dust, moisture and noise.
- **Protects terminal boxes, pot heads and bushings** from corrosive elements.
- **Deadens switch gear panel noise.**
- **Asbestos-free, non-hardening sealing mastic** adheres to metal, glass, rubber, wood, painted surfaces and plastic.
- **Easily molded by hand.** Dough-like compound is easily "thumbed" over holes and gaps.
- **Will not harden or form a skin** under normal conditions.

| SKU NO. | CATALOG NUMBER | DESCRIPTION | PACKAGE QUANTITY |
|---------|----------------|--------------------|------------------|
| 512965 | DS-100 | Duct Seal Compound | 45 Pugs |
| 512970 | DS-500 | Duct Seal Compound | 9 Pugs |



SCOTCHKOTE Electrical Coating

This fast-drying coating provides extra protection to splices where moisture, oil and corrosive conditions can cause problems. Helps prevent cable and connector damage due to corrosive vapors from battery outgassing.



| SKU No. | Mfg. No. | Size |
|---------|----------|--------|
| 510660 | 14853 | 16 oz. |

LOW VOLTAGE

**Splice Kit
Plyflex**



| SKU NO. | MFG. NO. | SIZE |
|---------|----------|--------------------------------|
| 500746 | 2635 | 500 Kcmil-Straight to #4/0 WYE |

HIGH VOLTAGE

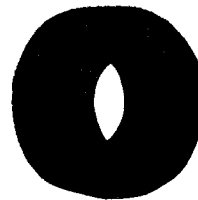

**15 Plybraid Tinned
Copper Shielding
Braid**

| SKU NO. | MFG. NO. | SIZE |
|---------|----------|----------|
| 500731 | 5415 | 1" x 15' |

INSULATING

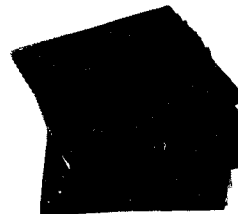

**4000 Plyseal-V
Vinyl Reinforced
Insulating Mastic**

| SKU NO. | MFG. NO. | SIZE |
|---------|----------|-----------------|
| 500742 | 2621 | 4" x 133" x 4" |
| 500748 | 2622 | 4" x 133" x 6½" |



INSULATED BELL WIRE STAPLES

- For low voltage bell, thermostat and telephone wiring.

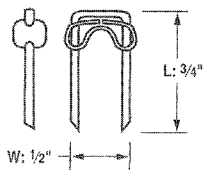

| SKU NO. | CATALOG NUMBER | DESCRIPTION | PACKAGE QUANTITY |
|---------|----------------|-------------|------------------|
| 502213 | MSB-40 | White | 40/Box |

PLASTIC STAPLES

- Use with Romex®, UF and other type NM cable up to 3-conductor
- Fast and easy to install- both zinc-plated nails drive together without splitting wood.
- Nail heads are recessed for minimum exposure.
- Smooth saddle prevents damage to insulation.
- High-grade injection-molded polyethylene resists rot, rust, deterioration and the effects of temperature extremes.
- UV protected.

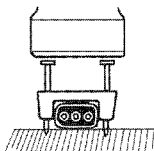

| SKU NO. | CATALOG NUMBER | DESCRIPTION | PACKAGE QUANTITY |
|---------|----------------|-----------------------------|------------------|
| 502171 | PS-2550 | 3/8" x 1/2" for 2-conductor | 40/Box |

| SKU NO. | CATALOG NUMBER | MARKER LEGENDS | QUANTITY |
|---------|----------------|---|-----------------|
| 509634 | 42-028 | Assortment "A" thru "Z", "0" thru "15", and symbols "+", "*", "7" | 10 markers each |
| 510845 | 42-029 | "1" thru "45" | 10 markers each |
| 510850 | 42-030 | "46" thru "90" | 10 markers each |

PLASTIC COAXIAL AND SOUND STAPLES

- Constructed of high-grade injection molded polyethylene cradles and zinc-plated nails.
- UV protected.
- Provides toughness, high dielectric strength and longevity.
- Smooth saddles hold wire securely while preventing damage.

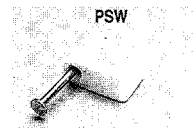

| SKU NO. | CATALOG NUMBER | DESCRIPTION | PACKAGE QUANTITY |
|---------|----------------|---------------------------|------------------|
| 502237 | PSW-1600 | 1/4" White Coaxial staple | 25/Card |

SCOTCHCODE Wire Marker Tape Dispenser

The handy SCOTCHCODE dispenser provides a fast, convenient system for color coding or number coding wire or cable. Using the special end loop, it can be hooked on a belt or tool pouch. The small size also makes it easy to carry in a pocket or tool box. The 10 refillable compartments allow you to choose the exact colors or numbers you need.

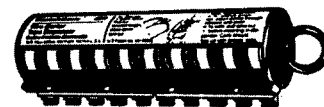

| SKU No. | Mfg. No. | For Tapes |
|---------|----------|-----------|
| 510790 | 12174 | 0-9 |

SCOTCHCODE Wire Marker Tape Dispenser

The handy SCOTCHCODE dispenser provides a fast, convenient system for marking wire or cable. The small size also makes it easy to carry in a pocket or tool box - always at hand. The 10 refillable compartments allow you to choose the exact number or color you desire. Dispenser is filled with either numbers 0 - 9 or 10 different colors and ready to use.



Refill Rolls

| SKU No. | Mfg. No. | For Tape # |
|---------|----------|------------|
| 510795 | 12176 | #0 |
| 510800 | 12178 | #1 |
| 510805 | 12180 | #2 |
| 510810 | 12182 | #3 |
| 510815 | 12184 | #4 |
| 510820 | 12186 | #5 |
| 510825 | 12190 | #6 |
| 510830 | 12192 | #7 |
| 510835 | 12194 | #8 |
| 510840 | 12198 | #9 |

7 Scotch™ 5-Way Penetrant

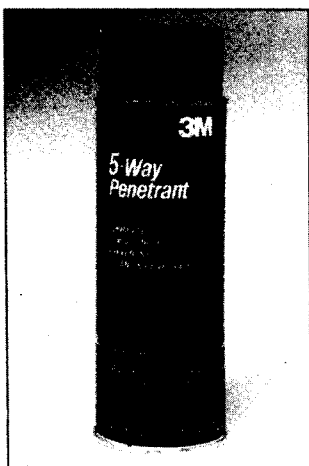

3M 5-Way penetrant is a multi-purpose product that is extremely effective as a demoisurant—displaces moisture and “drys out” electrical apparatus, prevents shorting, and increases conductivity; rust preventative—spreads a thin, even film that actually penetrates the pores of the surface to inhibit rust and corrosion; penetrant—frees rusted, frozen bolts and nuts.

| SKU No. | Mfg. No. | Size |
|---------|----------|------------|
| 510661 | 21305 | 16 1/4 oz. |



•SAVE TIME & LABOR WITH A TOP QUALITY TOOL

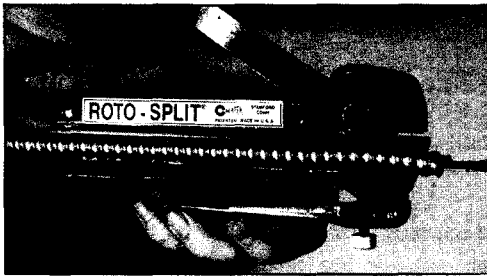

**ROTO-SPLIT® "SUPER"
 BX CABLE ARMOR STRIPPER**
 with New Ergonomic Handle & Blade
 Storage Cartridge.
 Cat. No. RS-101A "SUPER"

- A few turns of the crank produces a clean slit through the casing which can then be separated easily.
 - Unique quick clamping and release of the cable. No fuss side-loading.
 - Preset depth of cut at the factory for BX cables to prevent nicking of the conductors. Adjustment screw for thin wall MC cables.
 - Automatic compensation for cable size variation. A must for the fastest professional job in the trade!
- SKU NO. 507011**
 For 14-2 to 10-4 AC, MC, HCF, BX and 3/8" Greenfield.

ACCESSORIES: B-102 Replacement Blade.
SKU NO. 507009

**LOW COST ROTO-SPLIT®
 BX CABLE ARMOR STRIPPER**
 Cat. No. RS-101

This field proven quality cutter accepts BX cable from 14/2 to 10/4 and 3/8" Greenfield. Simplicity at its best!

The industry standard since 1973, the rugged RS-101 works exactly as the model above but features a thumb screw to clamp and release the cable. One part does it all! **SKU NO. 507003**

ACCESSORIES: B-102 Replacement Blade.

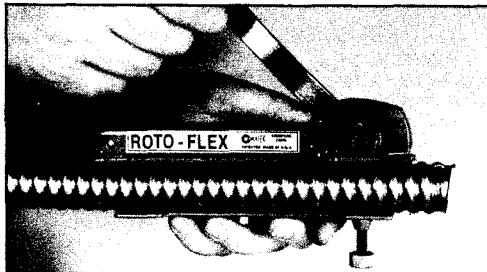
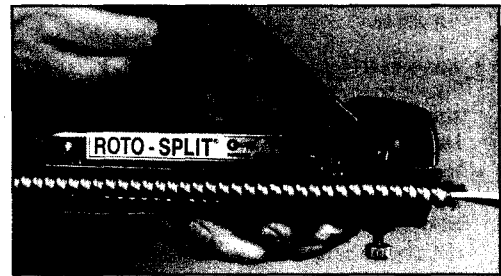

**ROTO-FLEX, GREENFIELD AND
 BX CABLE CUTTER**
 Cat. No. RF-120

This tool works on the same principle as the ROTO-SPLIT but accepts 1/2" and 3/4" Greenfield and large size BX up to 4/3. The Roto-Flex features the new ergonomic handle and blade storage cartridge in the knob.

•SAVE TIME – CUT COST!

The clean cut parallel to the cable axis eliminates deburring.

ACCESSORIES: B-102 Replacement Blade.

| SKU NO. | MFG NO. | CUTTER SIZE |
|---------|---------|-------------|
| 507006 | RF-120 | 1/2" — 3/4" |

**WIRE STRIPPER WITH ADJUSTABLE DIAL
 GENERAL HARDWARE**

SKU
 501138

MFG#
 69

Our catalog does not contain everything in our inventory. If there are products you do not find that are related to those in this catalog call 437-1288 so that we may assist you.





3" OCTAGONAL OUTLET BOXES – 1½" DEEP

| | | |
|------------------------------|--|---|
| BOWERS NO. 3-0-1/2 | | 1-1/2" DEEP – 3-1/2" OCTAGON One ½" K.O. in each of four sides, with one ½" K.O. in bottom. Knockout pressed to inside of box for easy removal. |
| SKU NO. 509260 | | |

4" OCTAGONAL OUTLET BOXES – 1½" DEEP

| | | |
|-----------------------------------|--|---|
| BOWERS NO. 4-0W-1/2 | | 1-1/2" DEEP – 4" OCTAGON One ½" K.O. in each of four sides, with five ½" K.O.'s in bottom. Knockouts pressed to inside of box for easy removal. |
| SKU NO. 509230 | | |
| BOWERS NO. 4-0W-3/4 | | 1-1/2" DEEP – 4" OCTAGON One ½" K.O. in each of four sides, three ½" K.O.'s in a line on the bottom and two ¾" K.O.'s on opposite ends in the bottom. |
| SKU NO. 509235 | | |
| BOWERS NO. 4-0W-SPL | | 1-1/2" DEEP – 4" OCTAGON One ½" K.O. in two sides, ¾" K.O.'s in two opposite sides with three ½" and two ¾" K.O.'s in bottom. |
| SKU NO. 509240 | | |
| BOWERS NO. 4-0W-EXT-SPL | | EXTENSION RING 1-1/2" DEEP – 4" OCTAGON One ½" K.O. in two sides and one ¾" K.O. in two opposite sides. Knockouts pressed to inside of box for easy removal. |
| SKU NO. 509245 | | |
| BOWERS NO. 4-0W-B-1/2 | | 1-1/2" DEEP – 4" OCTAGON One ½" K.O. in each of three sides, bracket on the other. Five ½" K.O.'s in bottom. Knockouts pressed to inside of box for easy removal. Flat bracket offset ½" from face. |
| SKU NO. 509250 | | |
| BOWERS NO. 4-0W-U-1/2 | | 1-1/2" DEEP – 4" OCTAGON One ½" K.O. in each of four sides with five ½" K.O.'s in bottom. Hanger bracket for overhead work. |
| SKU NO. 509255 | | |

4" SQUARE OUTLET BOXES – 1½" DEEP

| | | |
|----------------------------------|--|--|
| BOWERS NO. 4-SW-1/2 | | 1-1/2" DEEP – 4" SQUARE Welded box construction with three ½" K.O.'s in each side and five ½" K.O.'s in bottom. |
| SKU NO. 509285 | | |
| BOWERS NO. 4-SW-3/4 | | 1-1/2" DEEP – 4" SQUARE Welded box construction with two ¾" K.O.'s in each side. Three ½" K.O.'s in a line with two ¾" K.O.'s at opposite ends in bottom. |
| SKU NO. 509290 | | |
| BOWERS NO. 4-SW-SPL | | 1-1/2" DEEP – 4" SQUARE Welded box construction with two ½" K.O.'s and one ¾" K.O. in each side. Three ½" K.O.'s in a line with two ¾" K.O.'s at opposite ends in bottom. |
| SKU NO. 509295 | | |
| BOWERS NO. 4-SW-FB-1/2 | | 1-1/2" DEEP – 4" SQUARE Welded box construction with three ½" K.O.'s in each of three sides with flat bracket on fourth side. Five ½" K.O.'s in bottom. |
| SKU NO. 509337 | | |
| BOWERS NO. 4-SW-FB-SPL | | 1-1/2" DEEP – 4" SQUARE Welded box construction with two ½" K.O.'s and one ¾" K.O. in each of three sides with flat bracket on fourth side. Three ½" K.O.'s in a line on bottom with two ¾" K.O.'s at opposite ends in bottom. |
| SKU NO. 509340 | | |

* 10/32 TAPPED HOLE PROVIDED FOR GROUNDING SCREW

4" SQUARE OUTLET BOXES – 1½" DEEP

| | | |
|----------------------------------|--|---|
| BOWERS NO. 4-SW-LB-1/2 | | 1-1/2" DEEP – 4" SQUARE Welded box construction with three ½" K.O.'s in each of three sides, lateral bracket on other side set flush with top of box. Five ½" K.O.'s in bottom. |
| SKU NO. 509330 | | |

4" SQUARE EXTENSION RINGS – 1½" DEEP

| | | |
|-----------------------------------|--|--|
| BOWERS NO. 4-SW-EXT-1/2 | | EXTENSION RING 1-1/2" DEEP – 4" SQUARE Welded box construction with three ½" K.O.'s in each of four sides. |
| SKU NO. 509300 | | |
| BOWERS NO. 4-SW-EXT-3/4 | | EXTENSION RING 1-1/2" DEEP – 4" SQUARE Welded box construction with two ¾" K.O.'s in each of four sides. |
| SKU NO. 509305 | | |
| BOWERS NO. 4-SW-EXT-SPL | | EXTENSION RING 1-1/2" DEEP – 4" SQUARE Welded box construction with two ½" K.O.'s and one ¾" K.O. in each of four sides. |
| SKU NO. 509356 | | |

4" SQUARE OUTLET BOXES – 2½" DEEP

| | | |
|--------------------------------|--|--|
| BOWERS NO. 4-SDW-1/2 | | 2-1/8" DEEP – 4" SQUARE Welded box construction with three ½" K.O.'s in each of four sides. Five ½" K.O.'s in bottom. |
| SKU NO. 509310 | | |
| BOWERS NO. 4-SDW-3/4 | | 2-1/8" DEEP – 4" SQUARE Welded box construction with two ¾" K.O.'s in each of four sides. Three ½" K.O.'s in a line in bottom with two ¾" K.O.'s at opposite ends. |
| SKU NO. 509315 | | |
| BOWERS NO. 4-SDW-SPL | | 2-1/8" DEEP – 4" SQUARE Welded box construction with two ½" K.O.'s and one ¾" K.O. in all four sides. Three ½" K.O.'s in a line in bottom. Two ¾" K.O.'s at opposite ends. |
| SKU NO. 509320 | | |
| BOWERS NO. 4-SDW-1 | | 2-1/8" DEEP – 4" SQUARE Welded box construction with two 1" K.O.'s in each of four sides. Three ½" K.O.'s in a line in bottom. Two ¾" K.O.'s at opposite ends. |
| SKU NO. 509325 | | |

4-11/16" SQUARE OUTLET BOXES – 2½" DEEP

| | | |
|------------------------------------|--|---|
| BOWERS NO. 5-SDW-SPL | | 2-1/8" DEEP – 4-11/16" SQUARE Welded box construction with two ½" K.O.'s and one ¾" K.O. in each of four sides. Three ½" K.O.'s and two ¾" K.O.'s in bottom. Four tapped ears. |
| SKU NO. 509045 | | |
| BOWERS NO. 5-SDW-1 1/4 | | 2-1/8" DEEP – 4-11/16" SQUARE Welded box construction with two 1 ¼" K.O.'s in each of two sides, two 1" K.O.'s in other sides. Three ½" K.O.'s and two ¾" K.O.'s in bottom. Four tapped ears. |
| SKU NO. 509280 | | |
| BOWERS NO. 5-SDW-EXT-SPL | | EXTENSION RING 2-1/8" DEEP – 4-11/16" SQUARE Welded box construction with two ½" K.O.'s and one ¾" K.O. in each of four sides. Four tapped ears. |
| SKU NO. 509050 | | |

7



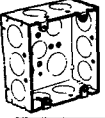
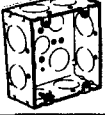

| | | |
|--------------------------------|---|--|
| BOWERS NO. 5-SDW-1/2 |  | 2-1/8" DEEP — 4-11/16" SQUARE Welded box construction with three 1/2" K.O.'s in each of four sides. Three 1/2" K.O.'s and two 3/4" K.O.'s in bottom. Four tapped ears. |
| SKU 509265 | | |
| BOWERS NO. 5-SDW-3/4 |  | 2-1/8" DEEP — 4-11/16" SQUARE Welded box construction with two 3/4" K.O.'s in two sides and three 1/2" K.O.'s in other two sides. Two 1/2" K.O.'s and three 3/4" K.O.'s in bottom. Four tapped ears. |
| SKU 509270 | | |
| BOWERS NO. 5-SDW-1 |  | 2-1/8" DEEP — 4-11/16" SQUARE Welded box construction with two 1" K.O.'s in each of four sides. Three 1/2" K.O.'s and two 3/4" K.O.'s in bottom. Four tapped ears. |
| SKU 509275 | | |

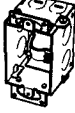
GANGABLE SWITCH BOXES — 2" DEEP

| | | |
|----------------------------|---|---|
| BOWERS NO. 51 |  | 2" DEEP — 3" LONG — 2" WIDE Two 1/2" K.O.'s in each of two sides. One 1/2" K.O. in each end and two 1/2" K.O.'s in bottom. Furnished with ears for old or cut in work, and two nail holes in each side. |
| SKU 509165 | | |
| BOWERS NO. 51-LC |  | 2" DEEP — 3" LONG — 2" WIDE Two 1/2" K.O.'s in two sides. Two Loom or Romex K.O.'s in each end and one 1/2" K.O. in bottom. Furnished with two Loom or Romex clamps with 10/32 deep slotted screws. Furnished with ears. Two nail holes in each side. |
| SKU 509166 | | |

GANGABLE SWITCH BOXES — 2 1/2" DEEP

| | | |
|----------------------------|---|---|
| BOWERS NO. 52 |  | 2-1/2" DEEP — 3" LONG — 2" WIDE Two 1/2" K.O.'s in each side. One 1/2" K.O. in each end. Two 1/2" K.O.'s in bottom. Furnished with ears. |
| SKU 509170 | | |
| BOWERS NO. 52-FB |  | 2-1/2" DEEP — 3" LONG — 2" WIDE Two 1/2" K.O.'s in one side. Flat bracket welded on opposite side. One 1/2" K.O. in each end. Two 1/2" K.O.'s in bottom. Flat bracket offset 9/16" from face. |
| SKU 509393 | | |



GANGABLE SWITCH BOXES — 2 3/4" DEEP

| | | |
|-------------------------|---|---|
| BOWERS NO. 53 |  | 2-3/4" DEEP — 3" LONG — 2" WIDE Two 1/2" K.O.'s in each side, one 1/2" K.O. in each end and two 1/2" K.O.'s in bottom. Furnished with ears. Four nail holes included. |
| SKU 509175 | | |

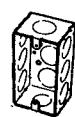
HANDY BOXES — 1 1/2" DEEP

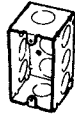

| | | |
|----------------------------|---|---|
| BOWERS NO. 102-W |  | 1-1/2" DEEP — 4" LONG — 2-1/8" WIDE Welded box construction. Three 1/2" K.O.'s in each of two sides. One 1/2" K.O. in each end. Three 1/2" K.O.'s in bottom. Four mounting holes in bottom. |
| SKU 509360 | | |

HANDY BOXES — 1 7/8" DEEP



| | | |
|--------------------------------|---|---|
| BOWERS NO. 103-W-1/2 |  | 1-7/8" DEEP — 4" LONG — 2-1/8" WIDE Welded box construction with three 1/2" K.O.'s in each of two sides. One 1/2" K.O. in each end. Three 1/2" K.O. in bottom. Four mounting holes in bottom. |
| SKU 509370 | | |
| BOWERS NO. 103-W-3/4 |  | 1-7/8" DEEP — 4" LONG — 2-1/8" WIDE Welded box construction with two 3/4" K.O.'s in each side. One 3/4" K.O. in each end. Two 3/4" K.O.'s in bottom. Four mounting holes in bottom. |
| SKU 509365 | | |

* 10/32 TAPPED HOLE PROVIDED FOR GROUNDING SCREW

HANDY BOXES — 1 7/8" DEEP

| | | |
|------------------------------------|---|---|
| BOWERS NO. 103-W-AB |  | 1-7/8" DEEP — 4" LONG — 2-1/8" WIDE Welded box construction with three 1/2" K.O.'s in one side. Angle bracket on opposite side offset 9/16". One 1/2" K.O. in each end. Three 1/2" K.O.'s in bottom. Four mounting holes in bottom. |
| SKU 509390 | | |
| BOWERS NO. 103-W-EXT-1/2 |  | EXTENSION RING 1-7/8" DEEP — 4" LONG — 2-1/8" WIDE Welded box construction with three 1/2" K.O.'s in each side. One 1/2" K.O. in each end. |
| SKU 509385 | | |

HANDY BOXES — 2 1/8" DEEP

| | | |
|--------------------------------|---|---|
| BOWERS NO. 104-W |  | 2-1/8" DEEP — 4" LONG — 2-1/8" WIDE Welded box construction with three 1/2" K.O.'s in each of two sides. Three 1/2" K.O.'s in bottom. Four mounting holes in bottom. One 1/2" K.O. in each end. |
| SKU 509375 | | |
| BOWERS NO. 104-W-3/4 |  | 2-1/8" DEEP — 4" LONG — 2-1/8" WIDE Welded box construction with two 3/4" K.O.'s in each of two sides. One 3/4" K.O. in each end. Two 3/4" K.O.'s in bottom. Four mounting holes in bottom. |
| SKU 509380 | | |

4" PANCAKE BOXES

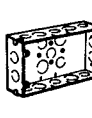
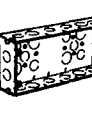

| | | |
|--------------------------|---|--|
| BOWERS NO. 410 |  | 1-1/2" DEEP — 4" DIAMETER Five 1/2" K.O.'s in bottom. Furnished with two 8/32 x 1/2" screws. |
| SKU 503112 | | |

MULTI-GANG BOXES

| | | |
|------------------------------|---|---|
| BOWERS NO. 703-SPL |  | 1-13/16" DEEP — 4-9/16" LONG — 8-3/4" WIDE A three gang box. Three 1/2" K.O.'s and two 3/4" K.O.'s in each of two sides. Two 1/2" K.O.'s in each end. Three 1/2" K.O.'s in a line in bottom with two 3/4" K.O.'s at opposite ends. Furnished with four 8/32 screws. |
| SKU 508950 | | |
| BOWERS NO. 704-SPL |  | 1-13/16" DEEP — 4-9/16" LONG — 10-9/16" WIDE A four gang box. Four 1/2" K.O.'s and two 3/4" K.O.'s in each of two sides. Two 1/2" K.O.'s in each end. Six 1/2" K.O.'s and four 3/4" K.O.'s in bottom. Furnished with four 8/32 screws. |
| SKU 508955 | | |

7

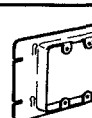
MULTI-GANG RINGS

| | | |
|--------------------------|---|---|
| BOWERS NO. 803 |  | 3/4" RAISED — 4-9/16" LONG — 8-3/4" WIDE A three gang switch ring designed to fit a #703 or #702 gang box. |
| SKU 508970 | | |
| BOWERS NO. 804 |  | 3/4" RAISED — 4-9/16" LONG — 10-9/16" WIDE A four gang switch ring designed to fit a #703 or #704 gang box. |
| SKU 508975 | | |

4" SQUARE BOXES 1-1/2" DEEP
21.0 CUBIC INCH CAPACITY

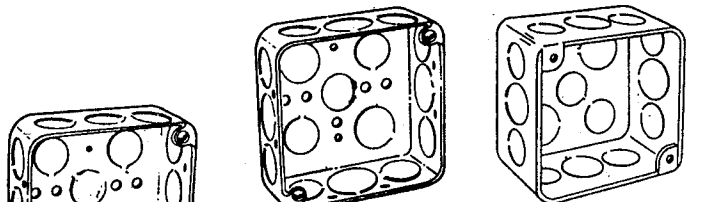

1/2" KO
 #52151 1/2
 SKU NO. 509487

1/2 & 3/4 KO
 #52151S
 SKU NO. 509492

4" x 4" x 1 1/2"
 #52151SVT
 SKU NO. 509481

Plenum Box
 For dust resistant application

Handy Box Covers

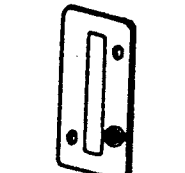

For
3 3/4" x 1" x 1 1/2"
BOX

SKU No. 509350 Mfg. No. 2520

4" SQUARE
 BOX COVER

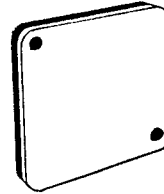

#52C1VT
 SKU NO. 509482

GEM BOX
 W/"SNAP" CLIP
 1 1/2" DEEP
 11.0 CUBIC INCH
 CAPACITY

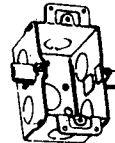

#CB-8
 SKU NO. 508675



4" x 2 1/8" Handy Boxes

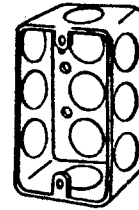

Mfg. No. 4CSL 1/2"
 1 1/4" Deep
 SKU No. 509365

HANDY BOX
3 3/4" x 1" x 1 1/2"

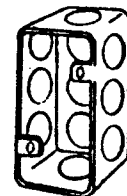

Mfg. No. 4SS
 1 1/2" Deep
 SKU No. 509345

3" x 2" Square Corner Switch Boxes

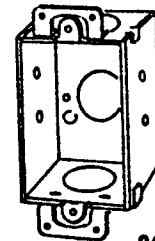

94
 1 1/2" Deep
 Plaster ears
 SKU No. 509395



ADJUSTABLE BAR HANGERS

BOWERS NO.
BHS

SKU
 509225



A bar hanger adjustable for joist spacing from 16" on center to 24" on center. Minimum adjustment 13 3/4". Offset 1". Clip provided for box attachment.

BRONZE GROUND CLAMPS

| SKU# | MFG# | SIZE |
|--------|--------|-------------|
| 505081 | JPS-12 | 1/2" |
| 505082 | JPS-34 | 3/4" |
| 505077 | J-JR | 1/2" - 1" |
| 505064 | JA-2 | 1-1/4" - 2" |

DIE CAST GROUND CLAMP

| | | |
|--------|--------|-----------|
| 505079 | BJ - 1 | 1/2" - 1" |
|--------|--------|-----------|



GREEN GROUNDING SCREWS

For easy fastening of ground wires leads to electrical boxes (10-32, 3/8" washer head, self tapping)

| SKU No. | Catalog No. | Description |
|---------|-------------|-----------------------------|
| 512973 | GGG-1512R | For switch and outlet boxes |

GROUNDING RODS

| SKU | DIAMETER | LENGTH | COATING | MODEL NO. |
|--------|----------|--------|------------|-----------|
| 235788 | 1/2" | 96" | Copper | 5008 |
| 235796 | 5/8" | 96" | Copper | 6258 |
| 477729 | 1/2" | 96" | Galvanized | CC 5008 |
| 240028 | 3/8" | 48" | Copper | 4401 |



Queen Products

JUNCTION BOXES

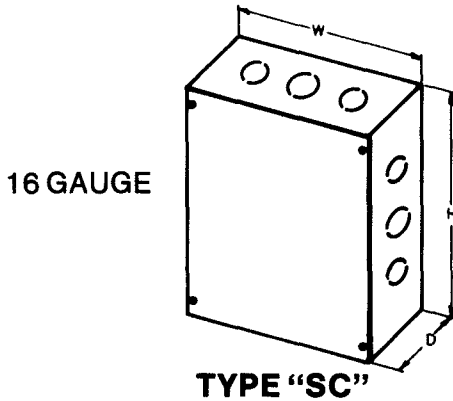
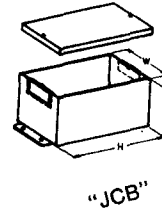

Oil Tight JIC Boxes

USAGE

JIC boxes are used in areas or on machines requiring dust proof and oil tight enclosures. They can be used as junction boxes, relay boxes, stepdown boxes and small panelettes. They are especially desirable as machinery wiring enclosures, or panel and instrument enclosures. Also used for outdoor weather-proof enclosures.

OIL TIGHT JIC BOXES

| SKU NO. | MFG. NO. | GAUGE | SIZE | PANEL SIZE |
|---------|-----------|-------|----------------|-------------------|
| 505158 | JCB-443 | 16 | 4" x 4" x 3" | No Panel |
| 505161 | JCB-444 | 16 | 4" x 4" x 4" | Piano Hinge Cover |
| 505163 | JCB-664 | 16 | 6" x 6" x 4" | 47/8" x 27/8" |
| 505164 | JCB-864 | 14 | 8" x 6" x 4" | 63/4" x 47/8" |
| 505166 | JCB-1084 | 14 | 10" x 8" x 4" | 83/4" x 67/8" |
| 505167 | JCB-12106 | 14 | 10" x 10" x 6" | 103/4" x 87/8" |
| 505169 | JCB-14126 | 14 | 14" x 12" x 6" | 123/4" x 107/8" |

JUNCTION BOXES 16 GAUGE

| SKU NO. | MFG. NO. | SIZES |
|-----------------|----------|----------------|
| 505087 | SCE | 10" x 10" x 4" |
| 505142 | SCE | 10" x 10" x 6" |
| 505137 | SCE | 8" x 10" x 6" |
| 505116 | SCE | 10" x 12" x 4" |
| 505143 | SCE | 10" x 12" x 6" |
| 505088 | SCE | 12" x 12" x 4" |
| 505144 | SCE | 12" x 12" x 6" |
| 505134 | SCE | 6" x 12" x 6" |
| 505113 | SCE | 12" x 8" x 4" |
| 505139 | SCE | 8" x 12" x 6" |
| 505118 | SCE | 12" x 15" x 4" |
| 505146 | SCE | 12" x 15" x 6" |
| 505121 | SCE | 15" x 15" x 4" |
| 505149 | SCE | 15" x 15" x 6" |
| 505119 | SCE | 12" x 18" x 4" |
| 505148 | SCE | 12" x 18" x 6" |
| 505122 | SCE | 15" x 18" x 4" |
| 505151 | SCE | 15" x 18" x 6" |
| 505124 | SCE | 18" x 18" x 4" |
| 505152 | SCE | 18" x 18" x 6" |
| 14 GAUGE | | |
| 505154 | SCE | 18" x 24" x 6" |
| 505157 | SCE | 24" x 24" x 6" |
| 16 GAUGE | | |
| 505106 | SCE | 4" x 4" x 4" |
| 505107 | SCE | 6" x 4" x 4" |
| 505084 | SCE | 6" x 6" x 4" |
| 505083 | SCE | 6" x 6" x 6" |
| 505109 | SCE | 8" x 6" x 4" |
| 505133 | SCE | 6" x 8" x 6" |
| 505112 | SCE | 8" x 8" x 4" |
| 505136 | SCE | 8" x 8" x 6" |

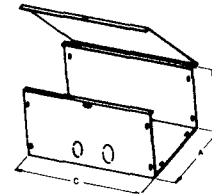

LAY-IN TROUGH

FEATURES

- ★ **ROUND CORNERS** — no sharp bending, dragging or cutting of wire.
- ★ **EMBOSSED & EXTRUDED TAPPED HOLES** — protects wire from damage by screw.
- ★ **INTERCHANGEABLE** — with any existing installation.
- ★ **KEY HOLE SLOTS** — saves valuable time erecting and inspecting.
- ★ **ELONGATED HOLES** — for perfect alignment.
- ★ **ONE LOW PRICE** — for both "HCT" and "SCT". No mixup in estimating jobs.
- ★ **GRAY OR GALVANIZED** — SAME LOW PRICE.

| SKU NO. | MFG. NO. | SIZES |
|---------|----------|--------------|
| 505127 | ST-41 | 4" x 4" x 1" |
| 505131 | ST-61 | 6" x 6" x 1" |

END CAPS

END CAPS

| SKU NO. | MFG. NO. | SIZES |
|---------|----------|---------|
| 505128 | CPT-4 | 4" x 4" |
| 505141 | CPT-6 | 6" x 6" |

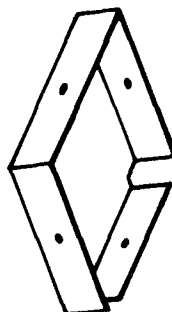

**E-Z MOUNT BRACKET CO.
 NEW COMBINATION BRACKET**

**ONE BRACKET WITH E-Z TABS
 FOR 2 1/2" AND 3 1/2" METAL STUDS.**

E-Z-T-4

Bracket: 4" and 4 11/16" Outlet Boxes

INSTALLATION:

1. Secure bracket to metal stud with self tapping screws or screw gun. Elongated side of bracket can go back to wall for added strength.

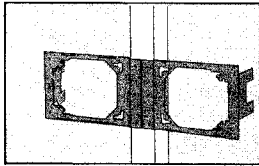
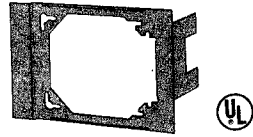
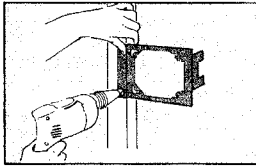

Mounted to form double on both sides of metal stud.

2. Slip outlet box screws into holes or slots on side portion of bracket, make up joints etc.

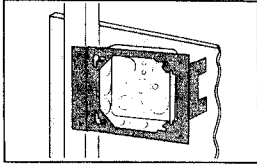

3. Secure drywall ring onto side portion of bracket.

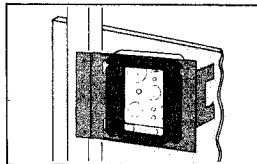

SKU No. 501474 Mfg. No. E2-T4

SWITCH BOX SUPPORT

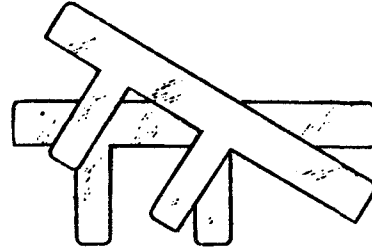

SKU NUMBER 506201 MFG NUMBER 40490

EAR CONVERTERS

TAPPED 8-32 FOR MOUNTING NEW STYLE COVER

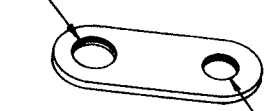

TAPPED 6-32 TO FASTEN UNDER EAR IN OLD BOX

ACTUAL SIZE

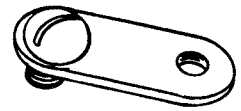

#EC
 SKU NO. 509480

Switch Box



892 "LOX BOX" Switch Box Supports
 SKU No. 509398

7

Our catalog does not contain everything in our inventory. If there are products you do not find that are related to those in this catalog call 437-1205 so that we may assist you.



- Galvanized steel.
- UL listed.

4" Round Flat

4" Round Raised

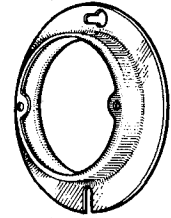
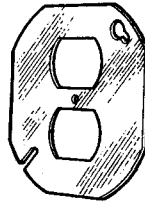
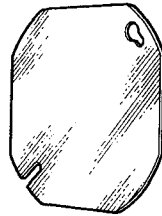

| SKU NO. | MFG. NO. | Description |
|---------|----------|-------------------|
| 509060 | 11101 | Blank |
| 509065 | 11103 | 1/2" Knockout |
| 509070 | 11105 | Duplex Receptacle |

| SKU NO. | MFG. NO. | Description |
|---------|----------|------------------------|
| 509080 | 11124 | 3" Opening Raised 5/8" |

4" Square Flat

4-11/16" Square Flat

1 Device — 4" Square

2 Devices

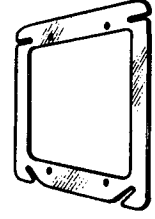
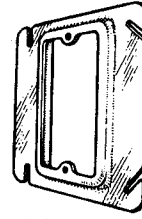
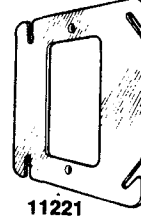
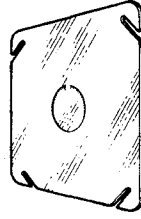
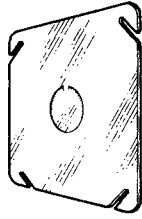

| SKU NUMBER | MFG NUMBER | DESCRIPTION |
|------------|------------|--|
| 508925 | 11201 | Blank |
| 509160 | 11203 | 1/2" Knockout |
| 509155 | 11215 | 3" Opening (ears tapped, 2.75" CC)—Raised 1/2" |

| SKU NUMBER | MFG NUMBER | DESCRIPTION |
|------------|------------|---------------|
| 508715 | 11301 | Blank |
| 508720 | 11303 | 1/2" Knockout |

| SKU NUMBER | MFG NUMBER | DESCRIPTION |
|------------|------------|-------------|
| 509095 | 11221 | Flat |
| 509100 | 11223 | Raised 1/4" |
| 509105 | 11226 | Raised 1/2" |
| 509110 | 11227 | Raised 5/8" |
| 509115 | 11228 | Raised 3/4" |
| 509120 | 11230 | Raised 1" |

509151 11245 Raised 1-1/4"

2 Devices — 4-11/16" Square

UTILITY COVERS

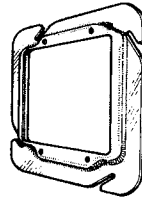
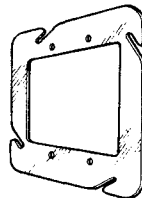

| SKU NUMBER | MFG NUMBER | DESCRIPTION |
|------------|------------|-------------|
| 508930 | 11335 | Flat |
| 508935 | 11340 | Raised 1/2" |

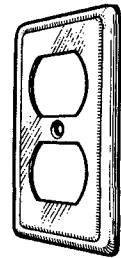
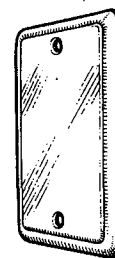

| SKU NO. | MFG NUMBER | DESCRIPTION |
|---------|------------|-------------------|
| 505745 | 10001 | Blank |
| 505750 | 10002 | Duplex |
| 505755 | 10003 | Single Receptacle |
| 505760 | 10004 | Toggle |
| 505765 | 10005 | 1/2" Knockout |

| | | |
|--------|-------|--|
| 505775 | 10009 | 1.620" dia. 20A Twist Lock receptacle |
| 505780 | 10010 | 1.730" dia. Twist Lock Receptacle 30A Appliance Switch |

505785 10021 Appliance Switch .4687"

• Electro-plated finish steel. UTILITY COVERS

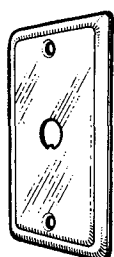
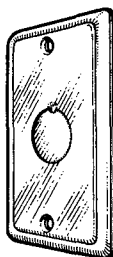
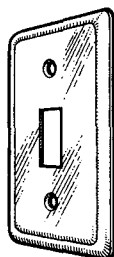
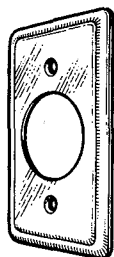

10003

10004

10005

10021



Mulberry

- Fully depressed corners for easier, faster mounting.
- Baked Cadilite finished steel. • UL listed.

FINISHED COVERS

4" Square, 1/2" DEEP

1 Device — 2 Devices

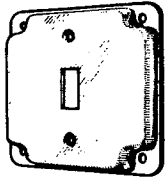

11401

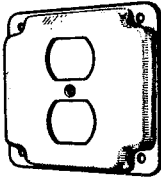

11402

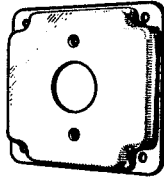

11403

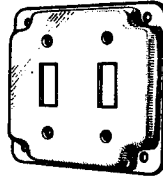

11410

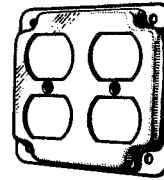

11411

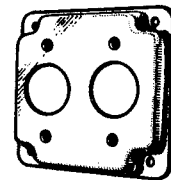

11412

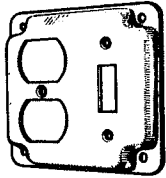

11413

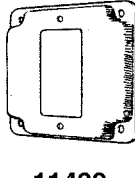

11432

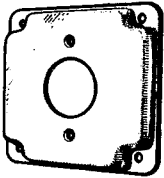

11421

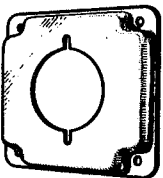

11422

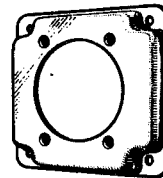

11423

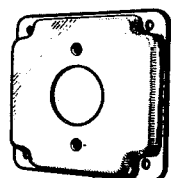

11425

| SKU NUMBER | MFG NUMBER | DESCRIPTION |
|------------|------------|-------------------------------------|
| 505635 | 11400 | Blank |
| 505810 | 11401 | 1 Toggle |
| 505815 | 11402 | 1 Duplex |
| 505830 | 11403 | 1 Standard Single Receptacle |
| 505820 | 11410 | 2 Toggle Switches |
| 505825 | 11411 | 2 Duplex Receptacles |
| 505835 | 11412 | 2 Single Receptacles (spaced 2" CC) |

| SKU NUMBER | MFG NUMBER | DESCRIPTION |
|------------|------------|---------------------------------------|
| 505630 | 11413 | Toggle-Duplex |
| 505840 | 11421 | 1.620" dia. 20A Twist Lock Receptacle |
| 505855 | 11422 | 2.125" dia. Range/Dryer Receptacle |
| 505850 | 11423 | 2.480" dia. Power Outlet |
| 505845 | 11425 | 1.730" dia. Twist Lock Receptacle |
| 505860 | 11432 | 1 GFCI Receptacle |

FINISHED COVERS

4-11/16" Square, 1/2" DEEP

- Baked Cadilite Finished steel.
- UL listed.

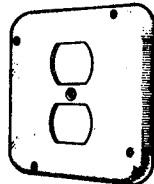

11502

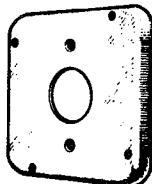

11503

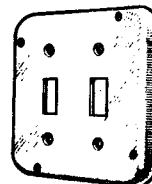

11510

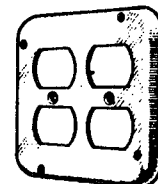

11511

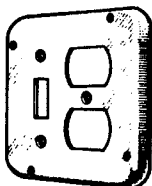

11513

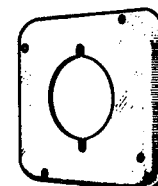

11522

| SKU NUMBER | MFG NUMBER | DESCRIPTION |
|------------|------------|------------------------------|
| 508730 | 11502 | Duplex |
| 508735 | 11503 | 1 Standard Single Receptacle |
| 508740 | 11510 | 2 Toggle Switches |
| 508745 | 11511 | 2 Duplex Receptacles |
| 508750 | 11513 | Toggle - Duplex |

| SKU NUMBER | MFG NUMBER | DESCRIPTION |
|------------|------------|------------------------------------|
| 508760 | 11522 | 2.125" dia. Range/Dryer Receptacle |

