

# Fasteners

Categories	Pages
BRASS MACHINE SCREWS & ASSORTED FASTENERS	413
BRASS WOOD SCREWS & SPECIALITY SCREWS	410
DRYWALL & DECK SCREWS	428
HELICOILS	415
HEX BOLTS GRADE 2, 5, 8	403-405
HEX BOLTS METRIC	404
LAG BOLTS & CARRIAGE BOLTS	405
MACHINE SCREWS ROUND & FLAT HEAD STEEL	406
MASONRY ANCHORS	417-422
MISCELLANEOUS SPECIALTY FASTENERS	429
NAILS & STAPLES - AIR DRIVEN	425
NAILS, HAND DRIVEN	423-424
NUTS & SPECIALTY WASHERS	408
NUTS METRIC	404
ONE-WAY SCREWS, E-RINGS, SPECIALTY FASTENERS	414
POP RIVETS	430
POWER ACTUATED FASTENERS	426-427
SELF DRILLING SCREWS	421
SHEET METAL SCREWS	409
SOCKET CAP SCREWS, ALLOY-SET & FLAT HEAD	407
STAINLESS STEEL HEX BOLTS, CARRIAGE BOLTS	412
STAINLESS STEEL SCREWS	412
THREADED ROD & COUPLER NUTS	416
WOOD SCREWS	410





**GRADE 2  
 HEX CAP SCREWS  
 NATIONAL COARSE THREAD  
 BOX QUANTITIES WILL VARY**

SIZE	¼"	⅜"	½"	⅝"	¾"	⅞"	1"	1¼"	1½"	2"	
½"	853915	853935									
¾"	853916	853936	853956								
1"	853917	853937	853957	853995	854017	854039					
1¼"	853918	853938	853958	853996	854018						
1½"	853919	853939	853959	853997	854019	854041	854061				
1¾"	853920	853940	853960	853998	854020						
2"	853921	853941	853961	853999	854021	854043	854063	854083			
2½"	853923	853943	853963	854001	854023	854045		854085			
3"	853924	853944	853964	854002	854024	854046	854066	854086	854208	854215	854222
3½"	853925	853945	853965	854003	854025	854047		854087	854209	854216	854223
4"	853926	853946	853966	854004	854026	854048	854068	854088	854210	854217	854224
4½"	853927	853947	853967	854005	854027	854049		854089	854211	854218	854225
5"	853928	853948	853968	854006	854028	854050	854070	854090	854212	854219	854226
5½"	853929	853949	853969	854007	854029			854091	854213	854220	854227
6"	853930	853950	853970	854008	854030	854052	854072	854092	854214	854221	854228
6½"	853931	853951	853971	854009							
7"	853932	853952	853972	854010	854032	854054	854074	854094			
8"	853934	853954	853974	854012	854034	854056	854076	854096			
9"	853979	853983	853975	854013	854035	854057	854077	854082			
10"	853980	853984	853976	854014	854036	854058	854078	854084			
11"	853981	853985	853977	854015		854059	854079	854093			
12"	853982	853986	853978	854016		854060	854080	854095			

**5**

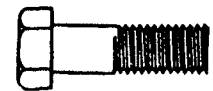
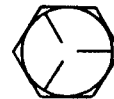
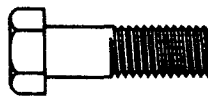

**GRADE 5  
 HEX CAP SCREWS  
 NATIONAL COARSE THREAD  
 ALL QUANTITIES BY PIECES**

**GRADE 5  
 HEX CAP SCREWS  
 NATIONAL FINE THREAD  
 ALL QUANTITIES BY PIECES**

SIZE	¼-20	⅜-18	½-16	⅝-14	¾-13	⅞-12	1-11	1¼-10
½"	853752	853772	853792					
¾"	853753	853773	853793	853812	853827			
1"	853754	853774	853794	853813	853828		853846	853864
1¼"	853755	853775	853795	853814	853829			
1½"	853756	853776	853796	853815	853830	853769	853848	853866
1¾"	853757	853777	853797					
2"	853758	853778	853798	853817	853832	853770	853850	853868
2¼"	853759				853833			
2½"	853760	853780	853800	853819	853834	853771	853852	853870
3"	853761	853781	853801	853820	853835	853779	853853	853871
3½"	853762	853782	853802	853821	853836	853786	853854	853872
4"	853763	853783	853803	853822	853837	853808	853855	853873
4½"	853764	853784	853804	853823	853838	853809	853856	853874
5"	853765	853785	853805	853824	853839	853810	853857	853875
6"	853767	853787	853807	853826	853841	853811	853859	853877

SIZE	¼-28	⅜-24	½-24	⅝-20	¾-20	⅞-18	1-18	1¼-16
½"	854735	854755	854775					
¾"	854736	854756	854776	854795				
1"	854737	854757	854777	854796	854811	854751	854829	854847
1¼"	854738	854758	854778	854797	854812	854752	854830	
1½"	854739	854759	854779	854798	854813	854753	854831	854849
1¾"	854740							
2"	854741	854761	854781	854800	854815	854754	854833	854851
2¼"		854762						
2½"	854743	854763	854783	854802	854817	854782	854835	854853
3"	854744	854764	854784	854803	854818	854769	854836	854854
3½"	854745	854765	854785	854804	854819	854771	854837	854855
4"	854746	854766	854786	854805	854820	854772	854838	854856
4½"	854747	854767	854787	854806	854821	854773	854839	854857
5"	854748	854768	854788	854807	854822	854774	854840	854858
5½"				854808				
6"	854750	854770	854790	854809	854824	854780	854842	854860

**Metric**

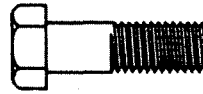

**Metric Hex Head  
 Cap Screw Coarse**

Size	M6	M8	M10	M12	M16	M20	M24
20MM	851100	851137	851183	851219			
25MM	851104	851142	851186	851222	851264		
30MM	851109	851148	851189	851225	851267		
35MM	851113	851152	851192	851228	851270	851309	
40MM	851118	851157	851195	851231	851273	851312	851360
45MM	851124	851161	851198	851234	851276	851315	851363
50MM	851128	851166	851201	851237	851279	851318	851366
55MM		851170	851204	851240	851282	851321	851369
60MM	851133	851175	851207	851243	851285	851324	851372
65MM		851179	851210	851246	851288	851327	851375
70MM			851213	851249	851291	851330	851378
75MM			851216	851252	851294	851333	851381
80MM				851255	851297	851336	851384
90MM				851258	851300	851339	851387
100MM				851261	851303	851342	851390
110MM					851306	851345	851393
120MM						851348	851396
130MM						851351	851399
140MM						851354	851402
150MM						851357	851405

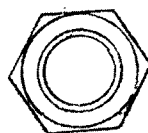

**Metric**

Size	Split Lock Washer	Flat Washer	Hex Nut Coarse
M6	851450	851429	851408
M8	851453	851432	851411
M10	851456	851435	851414
M12	851459	851438	851417
M16	851462	851441	851420
M20	851465	851444	851423
M24	851468	851447	851426

**5**



**GRADE 8  
 HEX HEAD CAP SCREWS  
 UNC COARSE THREAD  
 ALL QUANTITIES BY PIECES**

SIZE	1/4"	5/16"	3/8"	1/2"
3/4"	853698			
1"	853699	853710	853720	853731
1 1/2"	853701	853712	853722	853733
2"	853703	853714	853724	853735
2 1/2"	853705	853715	853726	853737
3"	853702	853716	853727	853738
3 1/2"	853704	853711	853728	853739
4"	853706	853713	853729	853740
5"	853707	853717	853725	853741
6"	853708	853718	853730	853742

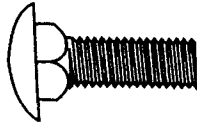

**CARRIAGE BOLTS  
 STEEL ZINC PLATED  
 ALL QUANTITIES BY PIECES**

SIZE	10/24"	1/4"	5/16"	3/8"	1/2"	5/8"
3/4"	850028	853577	853599	853621		
1"	850029	853578	853600	853622	853644	
1 1/4"	850031	853579	853601		853645	
1 1/2"	850032	853580	853602	853624	853646	
1 3/4"		853581		853625		
2"	850034	853582	853603	853626	853647	853667
2 1/2"	850037	853584	853605	853628	853649	853668
3"	850038	853585	853606	853629	853650	853669
3 1/2"	850041	853587	853608	853631	853652	853670
4"	850043	853588	853609	853632	853653	853671
4 1/2"		853589	853610	853633	853654	853672
5"		853590	853611	853634	853655	853673
5 1/2"		853591	853612	853635	853656	853674
6"		853592	853613	853636	853657	853675
6 1/2"		853593	853614	853637	853658	853676
7"		853594	853615	853638	853659	853677
8"		853596	853617	853640	853661	853679
9"			853618	853641	853662	853680
10"			853619	853642	853663	853681
11"				853597	853664	853598
12"				853643	853665	853682

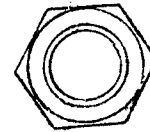

**STAINLESS**

SIZE	SPLIT LOCK WASHERS	FLAT WASHERS	NUTS
1/4"	854865	856020	856017
5/16"	854866	856021	856018
3/8"	854867	856022	856019

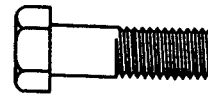

**STAINLESS STEEL  
 HEX BOLT  
 ALL QUANTITIES BY PIECES**

SIZE	1/4"	5/16"	3/8"
3/4"	855997		
1/2"	855998	856003	856010
3/4"	855999	856004	856011
1"	856000	856005	856012
1 1/4"	856002	856006	856013
1 1/2"	856001	856007	856014
2"	856009	856008	856015

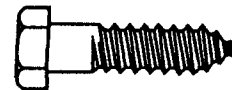

**LAG BOLTS  
 ALL QUANTITIES BY PIECES**

SIZE	1/4"	5/16"	3/8"	1/2"	5/8"
1"	853481	853494	853507		
1 1/4"	853482	853495	853508		
1 1/2"	853483	853496	853509	853523	
1 3/4"	853484				
2"	853485	853498	853511	853524	853539
2 1/2"	853486	853499	853512	853525	853540
3"	853487	853500	853513	853526	853541
3 1/2"	853488	853501	853514	853527	853542
4"	853489	853502	853515	853528	853543
4 1/2"	853490	853503	853516	853529	853544
5"	853491	853504	853517	853530	853545
5 1/2"	853492		853518	853531	
6"	853493	853506	853519	853532	853547
7"			853520	853534	853548
8"			853521	853535	853549
9"				853536	853550
10"			853522	853537	853551
12"				853538	853552

**5**

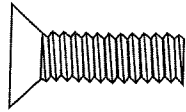
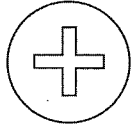

**PHILIPS FLAT HEAD  
 MACHINE SCREWS**  
 ALL QUANTITIES BY PIECES



**SLOTTED FLAT HEAD  
 MACHINE SCREWS**  
 ALL QUANTITIES BY PIECES  
 DESIGNATED BY A \*

SIZE	2-56	4-40	6-32	8-32	10-24	10-32	12-24	¼-20	⅝-18	⅞-16
¼"	854963	854973	854982	855000	855021	855046	855071			
⅜"		854975	854984	855002	855023	855048	855073	855089		
½"	854967	854977	854986	855004	855025	855050	855075	855091	855114	
⅝"	854968	854978	854987	855005	855026	855051	855076	855092		
¾"	854969	854979	854988	855006	855027	855052	855077	855093	855116	855135
7/8"				855007						
1"	854971 *	854981	854990	855008	855029	855054	855079	855095	855118	855137
1¼"			854992	855010	855031	855056	855080	855097	855119	855138
1½"			854993	855011	855032	855057	855081	855098	855120	855139
1¾"			854994 *	855012	855033 *	855058 *	855082 *	855099	855121 *	
2"			854995	855013	855034	855059	855083	855100	855122	855141
2¼"								855101 *	855123 *	
2½"				855015	855036	855061	855085	855102	855124	855143
2¾"								855103 *	855125 *	
3"				855017	855038	855063	855086	855104	855126	855145
3½"					855040	855065 *		855106	855127	855146
4"					855041	855066 *		855107	855128	855147
4½"										855148
5"					855043	855068 *		855109	855130	855149
6"					855045	855070 *		855111	855132	855151

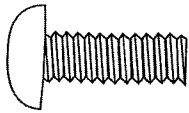
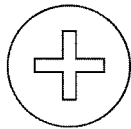

**PHILIPS ROUND HEAD  
 MACHINE SCREWS**  
 ALL QUANTITIES BY PIECES



**SLOTTED ROUND HEAD  
 MACHINE SCREWS**  
 ALL QUANTITIES BY PIECES  
 DESIGNATED BY A \*

SIZE	2-56	4-40	6-32	8-32	10-24	10-32	12-24	¼-20	⅝-18	⅞-16
¼"	855152	855162	855171	855189		855235				
⅜"	855154	855164	855173	855191	855212	855237	855262	855278		
½"	855156	855166	855175	855193	855214	855239	855264	855280	855303	
⅝"	855157 *	855167 *	855176	855194	855215 *	855240 *	855265			
¾"	855158	855168	855177	855195	855216	855241	855266	855282	855305	855324
7/8"				855196 *	855217 *					
1"	855160 *	855170	855179	855197	855218	855243	855268	855284	855307	855326
1¼"			855181	855199	855220	855245	855269	855286	855308	855327
1½"			855182	855200	855221	855246	855270	855287	855309	855328
1¾"			855183	855201	855222 *	855247	855271 *	855288	855310 *	855329 *
2"			855184	855202	855223	855248	855272	855289	855311	855330 *
2¼"						855249 *		855290 *	855312 *	
2½"				855204	855225	855250	855274	855291	855313	855332 *
2¾"								855292 *		
3"			855187 *	855206	855227	855252	855275	855293	855315	855334
3½"					855229	855254 *		855295	855316	855335
4"			855188 *	855209 *	855230	855255 *		855296	855317	855336
4½"					855231			855297	855318 *	855337 *
5"					855232	855257 *		855298	855319 *	855338 *
5½"					855233	855258 *			855320 *	
6"					855234	855259 *		855300	855321 *	855340 *

**ALLOY SOCKET HEAD  
 CAP SCREWS**  
 ALL QUANTITIES BY PIECES



SIZE	6-32	8-32	10-24	10-32	1/4	5/16	3/8	7/16	1/2	5/8	3/4
3/8"	855452	855458	855466	857006							
1/2"	855453	855459	855467	857007	855476	855488	855502				
5/8"	855454	854460	855468	857008	855477	855489	855503				
3/4"	855455	855461	855469	857009	855478	855490	855504	855520	855533		
7/8"	855456	855462	855470	857010		855491	855505	855521	855534		
1"	855457	855463	855471	857011	855480	855492	855506	855522	855535	855548	856548
1 1/4"		855464	855472	857012	855481	855493	855507	855523	855536	855549	
1 1/2"		855465	855473	857013	855482	855494	855508	855524	855537	855550	855562
1 3/4"			855474	857014	855483	855495	855509	855525	855538	855551	
2"			855475	857015	855484	855496	855510	855526	855539	855552	855564
2 1/4"					855485	855497	855511	855527	855540	855553	
2 1/2"					855486	855498	855512	855528	855541	855554	
3"					855487	855499	855513	855529	855542	855555	855567
3 1/2"						855501	855515	855531	855544	855557	
4"						855500	855516	855532	855545	855558	855570
5"							855518		855547	855560	

**ALLOY FLAT HEAD SOCKET  
 CAP SCREWS**  
 ALL QUANTITIES BY PIECES



SIZE	6-32	8-32	10-32	10-24	1/4	5/16	3/8	1/2
1/4"	854683							
3/8"	854684	854688	854905	854907	854909			
1/2"	854685	854689	854693	854897	854699	854707	854716	
5/8"	854686	854690	854694	854898	854700	854708	854717	
3/4"	854687	854691	854695	854900	854701	854709	854718	
1"	856687	854692	854696	854902	854702	854710	854719	854915
1 1/4"			854697	854903	854703	854711	854720	854917
1 1/2"			854698	854904	854704	854712	854721	854923
1 3/4"					854705	854713	854722	
2"					854706	854714	854723	854925
2 1/4"						854910	854911	
2 1/2"						854715	854724	854928
3"							854725	854930

**ALLOY BUTTON HEAD  
 SOCKET CAP SCREWS**  
 ALL QUANTITIES BY PIECES



SIZE	8-32	10.24	10.32	1/4	5/16
1/4"	857025	857030	857037		
3/8"	857026	857031	857038	857044	857050
1/2"	857027	857032	857039	857045	857051
5/8"	857028	857033	857040	857046	857052
3/4"	857029	857034	857041	857047	857053
7/8"		857035	857042	857048	857054
1"		857036	857043	857049	857055

**5**

**ALLOY SOCKET SET SCREWS  
 CUP POINT**  
 ALL QUANTITIES BY PIECES

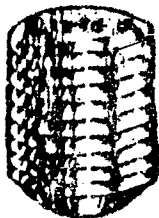

SIZE	6-32	8-32	10-24	10-32	1/4	5/16	3/8	7/16	1/2
1/8"	855571	855582							
3/16"	855572	855583	855593	857016	855601				
1/4"	855573	855584	855594	857017	855603	855614	855626		
5/16"	855574	855585	855595	857018		855615	855627		
3/8"	855575	855586	855596	857019	855605	855616	855628	855638	855648
7/16"	855576	855587	855597	857020	855606	855617	855629		855649
1/2"	855577	855588	855598	857021	855607	855618	855630	855640	855650
5/8"	855578	855589	855599	857022	855608	855619	855631	855641	855651
3/4"	855579	855590	855600	857023	855609	855620	855632	855642	855652
7/8"	855580	855591	855600		855610	855621	855633		855653
1"	855581	855592	855602	857024	855611	855622	855634	855644	855654
1 1/4"					855612	855623	855635		855655
1 1/2"					855613	855624	855636	855646	855656
2"						855625	855637	855647	855657
2 1/2"									855658
3"									855659

**INTERNAL LOCK  
 FLAT WASHERS  
 SPLIT LOCK WASHER**  
 ALL QUANTITIES BY PIECES

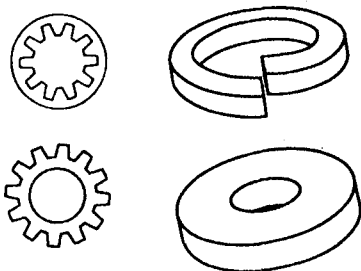

SIZE	ZINC SPLIT LOCK WASHERS	EXTERNAL LOCK	INTERNAL LOCK	BRASS FLAT WASHERS	SILICON BRONZE SPLIT LOCK WASHERS	FLAT WASHERS		
						EACH SKU	LB. SKU	NUMBER PER LB.
#6 (1/8")	856126	856150	856139	855821	857000	856161E	856161	790
#8 (5/32")	856127	856151	856140	855822	857001	856162E	856162	590
#10 (3/16")	856128	856152	856141	855823	857002	856163E	856163	361
1/4"	856130	856154	856143	855824	857004	856165E	856165	149
5/16"	856131	856155	856144	855825	857005	856166E	856166	87
3/8"	856132	856156	856145	855826	857003	856167E	856167	67
7/16"	856133					856168E	856168	41
1/2"	856134					856169E	856169	26
9/16"	856146					856170E	856170	22
5/8"	856135					856171E	856171	13
3/4"	856136					856172E	856172	9
7/8"	856137					856173E	856173	6
1"	856138					856174E	856174	5
1 1/8"						856123E		
1 1/4"						856124E		
1 1/2"						856125E		

5



**HEX NUTS**  
 ALL QUANTITIES BY PIECES

SIZE	MACH SCREW	FINISH COARSE THREAD	FINISH FINE THREAD	BRASS	JAM
2-56	856164				
4-40	856192				
5-40	856376				
6-32	856429			856102	
8-32	856430			856103	
10-24	856432			856104	
10-32	856433			856105	
12-24	856435			856106	
1/4-20		853566		856107	855003
5/16-18		853567		856108	855009
3/8-16		853568		856109	855018
7/16-14		853569			
1/2-13		853570		856110	855024
9/16-12		853575			
5/8-11		853571			
3/4-10		853572			
7/8-9		853573			
1-8		853574			
1/4-28			854726		
5/16-24			854727		
3/8-24			854728		
7/16-20			854729		
1/2-20			854730		
9/16-18			854733		
5/8-18			854731		
3/4-16			854732		
7/8-14			854734		
1-14			855001		
1 1/8-7		854205			
1 1/4-7		854206			
1 1/2-6		854207			

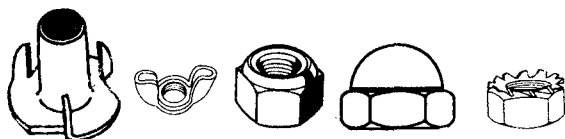

**SPECIALTY NUTS**  
 ALL QUANTITIES BY PIECES

SIZE	TEE NUTS	WING NUTS	NYLON INSERT LOCK N NUTS	CAP NUTS	KEP NUTS
6-32	856054	856061	856072	856092	856083
8-32	856055	856062	856073	856093	856084
10-24	856056	856063	856074	856094	856085
10-32	856057	856064	856075	856095	856086
1/4-20	856058	856066	856076	856096	856087
5/16-18	856059	856067	856077	856097	856088
3/8-16	856060	856068	856078	856098	856089
7/16-14		856069	856079	856099	
1/2-13		856070	856080	856100	
5/8-11		856071	856081		
3/4-10			856082		

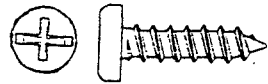

**PAN COMBO HEAD  
 SHEET METAL SCREWS  
 ALL QUANTITIES BY PIECES**

SIZE	4	6	8	10	12	14
1/4"	859105	859111				
3/8"	859106	859112	859120			
1/2"	859107	859113	859121	859131	859141	859150
5/8"	859108	859114	859122	859132	859142	859151
3/4"	859109	859115	859123	859133	859143	859152
1"	859110	859116	859124	859134	859144	859153
1 1/4"		859117	859125	859135	859145	859154
1 1/2"		859118	859126	859136	859146	859155
1 3/4"			859127	859137		859156
2"		859119	859128	859138	859147	859157
2 1/2"			859129	859139	859148	859158
3"			859130	859140	859149	859159

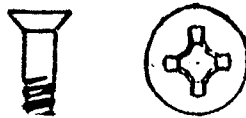

**PHILLIPS SHEET METAL SCREWS  
 ALL QUANTITIES BY PIECES**

SIZE	6	8	10	12
1/4"	854140			
3/8"	854141	854149	854158	
1/2"	854142	854150	854159	854167
5/8"	854143	854151	854160	
3/4"	854144	854152	854161	854169
1"	854145	854153	854162	854170
1 1/4"	854146	854154	854163	854171
1 1/2"	854147	854155	854164	854172
2"	854148	854157	854166	854174



**SLOTTED HEX WASHER-HEAD  
 TAPPING SCREWS  
 TYPE AB  
 ALL QUANTITIES BY PIECES**

SIZE	6	8	10	12	14
1/2"	854230	854237	854245		854261
5/8"	854231	854238	854246	854254	
3/4"	854232	854239	854247	854255	854263
1"	854233	854240	854248	854256	854264
1 1/4"	854234	854241	854249	854257	854265
1 1/2"	854235	854242	854250	854258	854266
1 3/4"			854251	854259	854267
2"		854244	854252	854260	854268



**SLOTTED SHEET METAL SCREWS  
 SLOTTED PAN HEAD SHEET METAL SCREWS  
 TYPE A  
 ALL QUANTITIES BY PIECES**

SIZE	4	6	8	10	12	14
1/4"	854489	854497	854516			
3/8"	854490	854498	854517			
1/2"	854491	854499	854518	854530	854541	854552
5/8"	854492	854500	854519	854531	854542	854553
3/4"	854493	854501	854520	854532	854543	854554
7/8"	854494	854502	854521	854533	854544	854555
1"	854495	854503	854522	854534	854545	854556
1 1/4"		854504	854523	854535	854546	854557
1 1/2"		854505	854524	854536	854547	854558
1 3/4"			854525	854537	854548	854559
2"		854506	854526	854538	854549	854560
2 1/2"			854527	854539	854550	854561
3"			854528	854540	854551	854562



**SLOTTED FLAT HEAD  
 SHEET METAL SCREWS  
 TYPE A  
 ALL QUANTITIES BY PIECES**

SIZE	4	6	8	10	12	14
1/4"	854415	854423				
3/8"	854416	854424		854455		
1/2"		854425	854444	854456		
5/8"		854426	854445	854457		
3/4"		854427	854446	854458	854469	854480
7/8"	854420	854428				
1"	854421	854429	854448	854460	854471	854482
1 1/4"		854430	854449	854461	854472	854483
1 1/2"		854431	854450	854462	854473	854484
1 3/4"					854474	854485
2"			854452	854464	854475	854486

**5**





**PHILLIPS FLAT-HEAD  
WOOD SCREWS**  
ALL QUANTITIES BY PIECES

SIZE	# 6	# 8	# 10	# 12
1/2"	854366	854374		
3/8"	854367	854375		
3/4"	854368	854376	854386	854396
1"	854370	854378	854388	854398
1 1/4"	854371	854379	854389	854399
1 1/2"	854372	854380	854390	854400
1 3/4"			854391	854401
2"	854373	854382	854392	854402
2 1/2"		854384	854394	854404
3"		854385	854395	854405
3 1/2"			854393	854406
4"			854397	854407

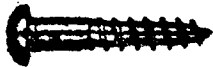

**SLOTTED BRASS WOOD SCREWS  
ROUND HEAD**  
ALL QUANTITIES BY PIECES

SIZE	4	6	8	10	12
1/4"	854563				
3/8"	854564		854584		
1/2"	854565	854574	854585		
3/4"	854566	854575	854586	854594	
1"	854567	854576	854587	854595	854605
1 1/4"	854569	854578	854589	854597	854607
1 1/2"	854570	854579	854590	854598	854608
1 3/4"	854571	854580	854591	854599	854609
2"		854582	854593	854601	854611
2 1/2"				854603	854612
3"				854604	854613

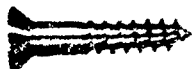

**SLOTTED BRASS WOOD SCREWS  
FLAT HEAD**  
ALL QUANTITIES BY PIECES

SIZE	4	6	8	10	12
1/4"	854623				
3/8"	854624	854633	854644		
1/2"	854625	854634	854645		
5/8"	854626	854635	854646	854654	
3/4"	854627	854636	854647	854655	854665
1"	854629	854638	854649	854657	854667
1 1/4"	854630	854639	854650	854658	854668
1 1/2"	854631	854640	854651	854659	854669
2"		854642	854653	854661	854671
2 1/4"				854662	
2 1/2"				854663	854672
3"				854664	854673



**SLOTTED STEEL WOOD SCREWS  
FLAT HEAD ZINC PLATED**  
ALL QUANTITIES BY PIECES

SIZE	4	6	8	10	12	14
1/4"	855341					
3/8"	855342	855351				
1/2"	855343	855352	855364	855381	855397	
3/4"	855344	855353	855365			
1"	855345	855354	855366	855383	855399	855411
1 1/4"	855346	855355	855367	855384	855400	
1 1/2"	855347	855356	855368	855385	855401	855412
1 3/4"	855348	855357	855369	855386	855402	855413
2"	855349	855358	855370	855387	855403	855414
2 1/4"		855359	855371	855388	855404	855415
2 1/2"		855360	855372	855389	855405	855416
2 3/4"			855373	855390		855417
3"			855361	855374	855391	855418
3 1/2"			855375			855426
4"			855376	855392	855408	855419
			855377	855393	855409	855420
			855378	855394	855410	855421
						855429



**SLOTTED STEEL WOOD SCREWS  
ROUND HEAD ZINC PLATED**  
ALL QUANTITIES BY PIECES

SIZE	4	6	8	10	12	14
1/4"	854269					
3/8"	854270	854279				
1/2"	854271	854280	854292	854309	854325	
3/4"	854272	854281	854293			
1"	854273	854282	854294	854311	854427	
1 1/4"	854274	854283	854295	854312	854328	
1 1/2"	854275	854284	854296	854313	854329	854340
1 3/4"	854276	854285	854297	854314	854330	854341
2"		854286	854298	854315	854331	854342
2 1/4"		854287	854299	854316	854332	854343
2 1/2"		854288	854300	854317	854333	854344
2 3/4"			854301		854334	854345
3"			854302	854319	854335	854346
3 1/2"			854303			
4"			854304	854320	854336	854347
				854321	854337	854348
				854322	854338	

5

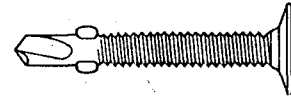
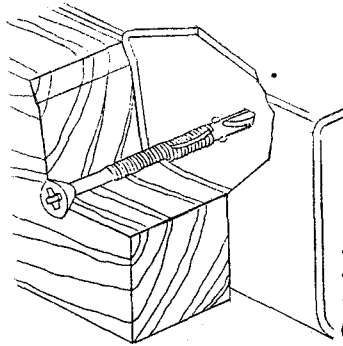

**WOOD OR PLYWOOD TO METAL**

1/4—20 x 2-3/4"  
**PHILLIPS FLAT HEAD**  
**TEKS/4 WITH WINGS**  
 3/4"—2" Wood to .060" to .250" Thick Steel Framing

10—24 x 1-7/16"  
**THIN WAFER HEAD**  
**TEKS/3 WITH WINGS**  
 1/4"—3/4" Plywood to .060" to .170" Thick Steel Framing  
 (also available without wings in 3/4" and 1")

SKU NO.	SIZE
851608	1/4—20 x 2-3/4"

SKU NO.	SIZE
851611	10-24 x 1-7/16"
851614	10-24 x 1"



**BRASS SLOTTED FLAT HEAD MACHINE SCREWS**  
 ALL QUANTITIES BY PIECES

SIZE	6-32	8-32	10-24	10-32	12-24	1/4-20
3/8"	855687	855703				
1/2"	855689	855705	855723	855732	855744	855760
5/8"	855690	855706	855724	855733	855745	855761
3/4"	855691	855707	855725	855734	855746	855762
1"	855693	855709	855727	855735	855748	855764
1 1/4"	855694	855710	855728	855736	855749	855765
1 1/2"	855695	855711	855729	855737	855750	855766
2"	855697	855713	855731	855738	855752	855768
2 1/2"						855770
3"						855771

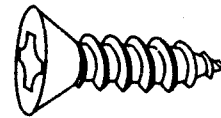

**STAINLESS STEEL**  
**PHILLIPS OVAL HEAD**  
**TAPPING SCREW**  
 ALL QUANTITIES BY PIECES

SIZE	#4	#6	#8	#10
1/4"	856023	856029		
3/8"	856024	856030		
1/2"	856025	856031	856039	856047
5/8"	856026	856032	856040	856048
3/4"	856027	856033	856041	856049
1"	856028	856034	856042	856050
1 1/4"		856035	856043	856051
1 1/2"		856036	856044	856052
2"		856037	856045	856053



**BRASS ROUND HEAD**  
 ALL QUANTITIES BY PIECES

SIZE	6-32	8-32	10-24	10-32	12-24	1/4-20
3/8"	855854	855870				
1/2"	855856	855872	855890	855899	855911	855927
5/8"	855857	855873	855891	855900	855912	855928
3/4"	855858	855874	855892	855901	855913	855929
1"	855860	855876	855894	855902	855915	855931
1 1/4"	855861	855877	855895	855903	855916	855932
1 1/2"	855862	855878	855896	855904	855917	855933
2"	855864	855880	855898	855905	855919	855935
2 1/2"						855937
3"						855938



**COTTER PINS EXTENDED PRONG**  
**ZINC PLATED**  
 ALL QUANTITIES BY PIECES

SIZE	1/16	3/32	1/8	5/32	3/16	1/4	5/16
3/4"			854913	854921			
1"	854899	854906	854914	854922			
1 1/2"	854901	854908	854916	854924	854933	854942	854951
2"			854918	854926	854935	854944	854953
2 1/2"					854937	854946	

**5**



**STAINLESS STEEL  
 PHILLIPS OVAL HEAD SCREWS**  
 ALL QUANTITIES BY PIECES

SIZE	#4	#6	#8	#10	#14
1/4"	856023	856029			
3/8"	856024	856030			
1/2"	856025	856031	856039	856047	
5/8"	856026	856032	856040	856048	
3/4"	856027	856033	856041	856049	
1"	856028	856034	856042	856050	856811
1 1/4"		856035	856043	856051	856812
1 1/2"		856736	856744	856052	856813
2"		856737	856745	856053	856814
2 1/2"					856815
3"					856816



**STAINLESS STEEL PAN HEAD  
 PHILLIPS SHEET METAL SCREWS**  
 ALL QUANTITIES BY PIECES

SIZE	#8	#10	#14
1/2"	856791	856797	
3/4"	856792	856798	
1"	856793	856799	856803
1 1/4"	856794	856800	856804
1 1/2"	856795	856801	856805
2"	856796	856802	856806
2 1/2"			856809
3"			856810

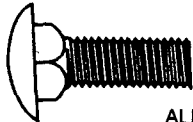

**CARRIAGE BOLTS  
 STAINLESS STEEL**  
 ALL QUANTITIES BY PIECES

SIZE	1/4"	5/16"	3/8"
3/4"	856710		
1"	856711	856716	856721
1 1/2"	856712	856717	856722
2"	856713	856718	856723
3"	856714	856719	856724
4"	856715	856720	856725



**STAINLESS STEEL  
 PHILLIPS FLAT HEAD SHEET METAL SCREWS**  
 ALL QUANTITIES BY PIECES

SIZE	#8	#10	#14
3/4"	856817	856822	
1"	856818	856823	856827
1 1/4"	856819	856824	856828
1 1/2"	856820	856825	856829
2"	856821	856826	856830

5



**STAINLESS STEEL  
 SLOTTED FLAT HEAD  
 MACHINE SCREWS**  
 ALL QUANTITIES BY PIECES

SIZE	8-32	10-24	1/4-20
1/2"	856744	856749	856755
3/4"	856745	856750	856756
1"	856746	856751	856757
1 1/4"	856747	856752	856758
1 1/2"	856748	856753	856759
2"		856754	856760



**STAINLESS STEEL**

SIZE	SPLIT LOCK WASHERS	FLAT WASHERS	FINISH WASHERS
#6	856842	856838	
#8	856843	856839	856835
#10	856844	856840	856836
1/4"	856865	856020	856837
5/16"	856866	856021	
3/8"	856867	856022	
1/2"	856845	856841	



**STAINLESS STEEL  
 PHILLIPS ROUND HEAD  
 MACHINE SCREW**  
 ALL QUANTITIES BY PIECES

SIZE	8-32	10-24	1/4-20
3/4"	856761	856765	856770
1"	856762	856766	856771
1 1/4"	856763	856767	
1 1/2"	856764	856768	856772
2"		856769	856773

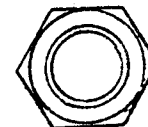

**STAINLESS STEEL  
 HEX NUTS**

SIZE	
6-32	856831
8-32	856832
10-24	856833
1/4"	856017
5/16"	856018
3/8"	856019
1/2"	856834

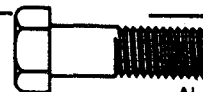

**STAINLESS STEEL  
 HEX BOLT**  
 ALL QUANTITIES BY PIECES

SIZE	1/4"	5/16"	3/8"	1/2"
3/8"	855997			
1/2"	855998	856003	856010	
3/4"	855999	856004	856011	
1"	856000	856005	856012	856736
1 1/4"	856002	856006	856013	856737
1 1/2"	856001	856007	856014	856738
2"	856009	856008	856015	856739
2 1/2"	856726	856730	856732	856740
2 3/4"	856727			
3"	856728	856731	856733	856741
3 1/2"	856729		856734	
4"	856846		856735	856742
5"				856743

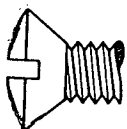

**STAINLESS STEEL  
 PHILLIPS OVAL MACHINE SCREW**  
 ALL QUANTITIES BY PIECES

SIZE	8-32	10-24	1/4-20
3/4"	856774	856779	
1"	856775	856780	856786
1 1/4"	856776	856781	
1 1/2"	856777	856782	856787
2"	856778	856783	856788
2 1/2"		856784	856789
3"		856785	856790

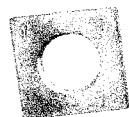

**BLACK  
BEVEL  
WASHER**

SIZE	SKU NO.
1/4"	850300
5/16"	850303
3/8"	850306
1/2"	850309
5/8"	850312
3/4"	850315
7/8"	850318
1"	850319

THESE FASTENERS ARE STOCKED IN SMALL QUANTITIES ONLY. LARGER QUANTITIES ARE AVAILABLE BY SPECIAL ORDER

SKU NO.	ITEM DESCRIPTION
85174	Aluminum fasteners assorted
85168	Aluminum machine screws & nuts
85171	Aluminum S.M.S. (pan & oval hd)
85306	Aluminum spacers
85165	Aluminum WD screws rd & oval hd
85174	Assorted aluminum fasteners
85288	Automotive studs
85189	Brass & bronze washers
85186	Brass cap & knurled nuts
85183	Brass machine screws & nuts
85279	Brass plated phillips flat sms
85282	Brass plated phillips pan sms
85177	Brass wood screws (chrome pltd)
85180	Brass wood screws (oval head)
85135	Chrome machine screws & nuts
85225	Chrome plated steel wood screws
85123	Cotter pins (brs, alum & s.s.)
85078	Finish washers (brass, steel, alum)
85096	Flat hd machine screws & nuts
85162	Flat head aluminum wood screws
85108	Flat head wood screws 2 & 4 dia.
85081	Flat washers sae
85228	Full thread hex bolts 1/4-20
85231	Full thread hex bolts 5/16-18
85234	Full thread hex bolts 3/8-16
85237	Full thread hex bolts 1/2-13
85198	Hardened hex nuts
85072	Hex nuts fine thread
85069	Hex nut uss & sae
85003	Hitch pin clips
85063	Left hand nuts (crse & fine thrd)
85126	Machine bushings
85047	Metric cap scr 6 & 8mm 50-100mm
85030	Metric cap screws gr 8 fine thread

SKU NO.	ITEM DESCRIPTION
85042	Metric cap screws gr 8 4 & 5mm
85045	Metric cap screws gr 8 6mm
85046	Metric cap screws gr 8 7mm
85048	Metric cap screws gr 8 8mm
85051	Metric cap screws gr 8 10mm
85054	Metric cap screws gr 8 12mm
85055	Metric cap screws gr 8 14mm
85056	Metric cap screws gr 8 16mm
85039	Metric lock washers & nuts
85213	Metric machine screws
85309	Metric Miniature Machine Screws
85240	Metric nuts wing, stop & acron
85036	Metric socket cap screws
85033	Metric socket set screws
85243	Metric washers flat & wavey
85273	Miniature machine screws ss 0-1
85276	Miniature machine screws ss 2-3
85300	Nylon insert stop nuts
85150	Nylon nuts & washers
85147	Nylon screws & nuts
85285	Nylon spacers
85087	One way S.M.S. (pan & oval head)
85219	Phil rnd hd mach screw #6 & #8
85222	Phil rnd hd mach screw #10 & 1/4
85216	Phillips flat head machine screw
85090	Phillips S.M.S (hardened)
85057	Pushnuts
85111	Rnd head wood screws 2 & 4 dia.
85099	Round hd machine screws & nuts
85255	S.S. hex washer hd S.M.S.
85204	S.S. nuts stop, cap & wing
85258	S.S. phil F.H. mach screw #6 & #8
85261	S.S. phil F.H. mch screw #10 & 1/4
85249	S.S. phil flat hd S.M.S.

SKU NO.	ITEM DESCRIPTION
85246	S.S. phil oval hd S.M.S
85264	S.S. phil P.H. mach screw #6 & #8
85267	S.S. phil P.H. mach screw 10-24
85270	S.S. p.h. mach screw 1/4-20
85252	S.S. phil pan hd S.M.S
85141	S.S. slot flat & oval hd S.M.S.
85144	S.S. slot r.h. mach screws & nuts
85138	S.S. slotted pan head S.M.S.
85006	Socket cap screws (fine thread)
85009	Socket set screws (fine thread)
85129	Split machine bushings
85012	Square head set screws
85015	Square machine keys
85303	Square nuts steel
85207	Stainless hex nuts
85201	Stainless oval hd machine screw
85291	Stainless steel carriage bolts
85294	Stainless steel hex lag screws
85210	Stainless washers flat & lock
85120	Steel cotter pins
85027	Taper pins
85159	Tee nuts (short & long prong)
85021	Tension pins (spring steel hard)
85093	Thread cutting screws (type F)
85000	Thumb screws
85060	Tinnerman speed nuts
85156	Tinners copper rivets & burrs
85075	Toothed lock washers
85195	Truss slotted machine screws
85153	Tubular & split rivets
85024	Universal clevis pins
85084	Welded rings
85066	Wing nuts (steel & bras)
85018	Woodruff keys

**5**

**ONE-WAY ROUND HEAD MACHINE SCREWS**  
 ALL QUANTITIES BY PIECES

SIZE	6-32	8-32	10-24	10-32	1/4-20
1/2"	855431	855434	855438	855442	855446
3/4"	855432	855435	855439	855443	855447
1"	855433	855436	855440	855444	855448
1 1/2"		855437	855441	855445	855449
2"					855450
3"					855451

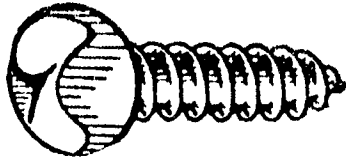

**ONE-WAY ROUND HEAD TAPPING SCREWS (TYPE A)**  
 ALL QUANTITIES BY PIECES

SIZE	6	8	10	14
3/8"	855978	855983	855988	
1/2"	855979	855984	855989	855993
3/4"	855980	855985	855990	855994
1"	855981	855986	855991	855995
1 1/4"	855982			
1 1/2"		855987	855992	855430
2"				855996



**HANGER BOLTS**  
 ALL QUANTITIES BY PIECES

SIZE	3/16	1/4	5/16	3/8
1 1/2"	854183	854187		
2"	854184	854188	854193	
2 1/2"	854185	854189	854194	854198
3"	854186	854190	854195	854199
3 1/2"		854191	854196	854200
4"		854192	854197	854201
4 1/2"				854202



**RETAINING RINGS**

SIZE	
1/4"	850503
5/16"	850599
3/8"	850602
7/16"	850605
1/2"	850608
9/16"	850683
5/8"	850686
3/4"	850689
7/8"	850692
1"	850695
1 1/8"	850698
1 1/4"	850701



**E RINGS**

SIZE	
3/16"	850704
7/32"	850707
1/4"	850710
5/16"	850713
3/8"	850716
7/16"	850719
1/2"	850722
5/8"	850725
3/4"	850728
7/8"	850731
1"	850734

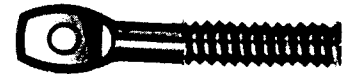

**FLAT END MACHINE SCREW**

SKU NO.	MFG. NO.	SIZE
850737	FE2513	1/4" x 4"
850740	FE2515	1/4" x 6"
850747	FE2535	3/8" x 4"

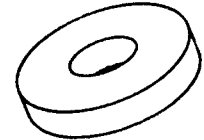

**FENDER & FINISH WASHER**  
 ALL QUANTITIES BY PIECES

PRODUCT NUMBER	BOLT SIZE	INSIDE DIA.	OUTSIDE DIA.	SKU NUMBER
PW 2	1/8"	5/32"	9/16"	856111
PW 3	3/16"	13/64"	1/2"	856436
PW 4	3/16"	7/32"	1 1/4"	856112
PW 8A	1/4"	9/32"	1 1/4"	856440
PW 8	1/4"	9/32"	2 1/32"	856113
PW 12	1/4"	9/32"	1 1/2"	856114
PW 13	1/2"	17/32"	1 1/2"	856115
PW 14	3/8"	13/32"	1 1/2"	856116
PW 15	1/4"	9/32"	2"	856117
PW 16	3/8"	13/32"	2"	856118
PW 17	1/2"	17/32"	2"	856119
PW 18	1/4"	9/32"	1 1/2"	856120
PW 19	1/4"	9/32"	2 1/2"	856121
PW 20	3/8"	13/32"	2 1/2"	856122

**STEEL FINISH WASHERS**

#6 (1/8)	#8 (5/32)	#10 (3/16)	#12	#14
856175	856176	856177	856178	856179

**BRASS FINISH WASHERS**

#6 (1/8)	#8 (5/32)	#10 (3/16)	#12	#14
856180	856181	856182	856183	856184

5

# HeliCoil

## SCREW THREAD INSERTS

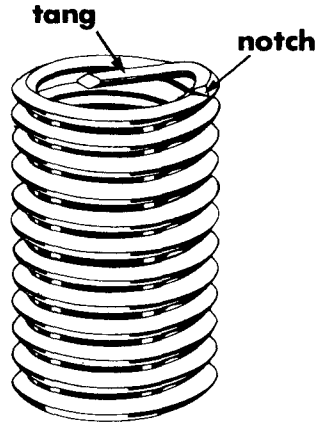

Heli-Coil Inserts are also available with a "Screw-Locking" feature: a series of chords on one or more of the coils of the insert. They positively lock screws and bolts from loosening from impact or vibration.

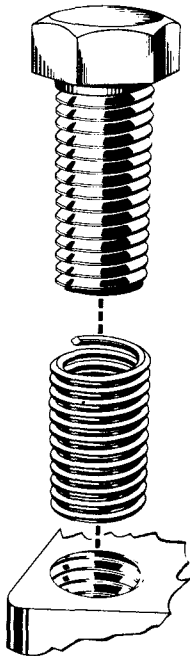

Heli-Coil has the most effective and universally accepted method of thread repair. Heli-Coil Inserts quickly and permanently restore stripped, worn or damaged threads to their original size and condition.

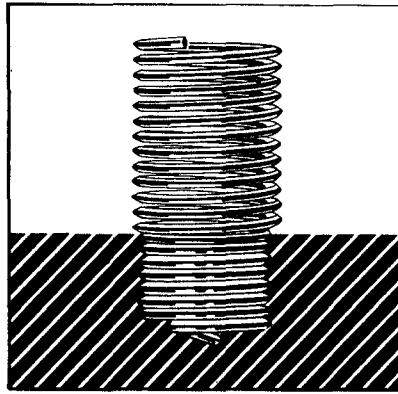

Heli-Coil Inserts are larger in diameter before installation than the tapped hole. During installation the inserting tool tightens the insert which reduces the diameter of the leading coil so it can enter the tapped hole. After installation, each high tensile stainless steel coil expands outward against the tapped hole to permanently anchor the insert.

### HELI-COIL THREADED INSERTS COARSE

SKU NO.	MFG NO.	SIZE
850002	R1185-06	6-32
850003	R1185-2	8-32
850004	R1185-3	10-24
850006	R1185-1	12-24
850007	R1185-4	1/4-20
850008	R1185-5	5/16-18
850009	R1185-6	3/8-16
850011	R1185-7	7/16-14
850012	R1185-8	1/2-13
850013	R1185-9	9/16-12
850014	R1185-10	5/8-11
850016	R1185-12	3/4-10

### FINE

850017	R1191-3	10-32
850018	R1191-4	1/4-28
850019.	R1191-5	5/16-24
850021	R1191-6	3/8-24
850022	R1191-7	7/16-20
850023	R1191-8	1/2-20
850024	R1191-9	9/16-18
850026	R1191-10	5/8-18
850027	R1191-12	3/4-16

### HELI-COIL TAPS FOR INSERTS UNIFIED COARSE

SKU NO.	MFG NO.	SIZE
700755	3CPB	10-24
700760	4CPB	1/4-20
700770	5CPB	5/16-18
700775	6CPB	3/8-16
700785	8CPB	1/2-13

### UNIFIED FINE

700790	3FPB	10-32
700800	4FPB	1/4-28
700805	5FPB	5/16-24
700815	6FPB	3/8-24
700820	8FPB	1/2-20

### THREADED REPAIR KITS



**5**

### INCH COARSE

SKU NO.	MFG NO.	SIZE + LENGTH
700550	5401-06	6/32 x .207
700560	5401-2	8/32 x .246
700565	5401-3	10/24 x .285
700575	5401-1	12/24 x .324
700580	5401-4	1/4-20 x .375
700590	5401-5	5/16-18 x .469
700595	5401-6	3/8-18 x .562
700650	5401-7	7/16-14 x .656
700655	5401-8	1/2-13 x .750
700665	5401-9	9/16-12 x .844
700670	5401-10	5/8-11 x .938
700680	5401-12	3/4-10 x 1.125

### INCH FINE

SKU NO.	MFG NO.	SIZE + LENGTH
700685	5402-3	10/32 x .285
700695	5402-4	1/4-28 x .375
700700	5402-5	5/16-24 x .469
700710	5402-6	3/8-24 x .562
700715	5402-7	7/16-20 x .656
700725	5402-8	1/2-20 x .750
700730	5402-9	9/16-18 x .844
700740	5402-10	5/8-18 x .938
700745	5402-12	3/4-16 x 1.125

# fully threaded steel rods

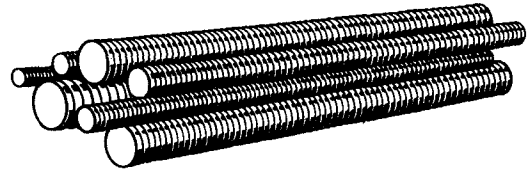
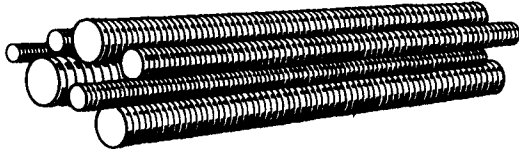

THREADED ROD

SIZE	1'	2'	3'	6'	12'
6-32	853000	853036	853078		
8-32	853003	853039	853081		
10-24	853009	853045	853087		
10-32	853006	853042	853084		
1/4-20	853012	853048	853090	853126	853143
5/16-18	853015	853051	853093		853146
3/8-16	853018	853054	853096	853129	853149
7/16-14		853057	853099		853152
1/2-13	853021	853060	853102	853131	853155
5/8-11	853024	853063	853108	853134	853158
3/4-10	853027	853066	853111	853137	853161
7/8-9	853030	853069	853114		
1-8	853033	853072	853117	853140	853164
1 1/8		853075	853120		
1 1/4			853123		

BRASS ROD

SIZE	1'	2'
6-32	852002	
8-32	852003	853193
10-24	852004	853199
10-32	852005	853196
1/4-20	853175	853202
5/16-18	853178	853205
3/8-16	853181	853208
1/2-13	853184	853211

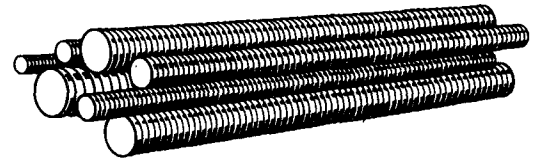

## STAINLESS STEEL

Type #304 (18-8)  
 NATIONAL COARSE THREADS  
 36" Lengths



FINE THREADED ROD

SIZE	2'	3'
1/4-28	853217	853247
5/16-24	853220	853250
3/8-24	853223	853253
7/16-20	853226	853256
1/2-20	853229	853259
5/8-18	853232	853262
3/4-16	853235	853265
7/8-14	853238	853268
1-14	853241	853271

LEFT-HANDED

SIZE	3'
1/4-20	856428
5/16-18	856431
3/8-16	856434
1/2-13	856437

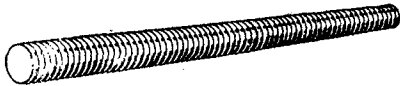

SKU NO.	MFC NO.	SIZE THREAD
853365	13303	6-32
853368	13304	8-32
853371	13305	10-24
853353	13306	1/4"-20
853356	13307	5/16"-18
853359	13308	3/8"-16
853362	13310	1/2"-13
853374	13311	5/8"-11
853387	13312	3/4"-10

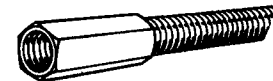

COUPLER NUTS

COARSE THREAD

FINE THREAD

SIZE	SKU NO.	SIZE	SKU
10-24	853274	10-32	852006
1/4-20	853277	1/4-28	852009
5/16-13	853280	5/16-24	852013
3/16-16	853283	3/8-24	852016
7/16-14	853287	7/16-20	852019
1/2-13	853290	1/2-20	852022
5/8-11	853293		
3/4-10	853296		
7/8-9	853299		
1-8	853302		
1 1/8-7	853305		
1 1/4-7	853308		

IN TERMINAL OPERATION  
 ALL QUANTITIES BY PIECES  
 ON COUPLERS & REDUCERS ONLY

5