

**Economy Swivel Caster**

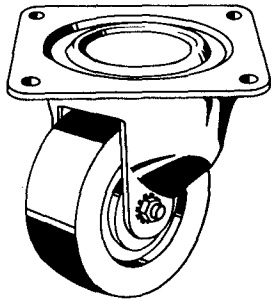

- Ideal for laundry, office and food service carts, and mover's dollies.
- Greater strength from no king pin LOCKWELD construction and rounded legs.
- Durable Epoxy Powder Coat finish.

IW = Steel Wheel  
 SR = Soft Rubber Wheel

**Fairbanks®**

**Rigid Caster**

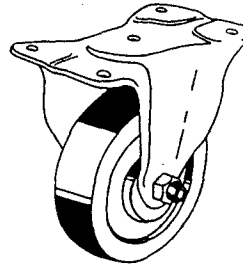

- Ideal for laundry, office, and food service carts, and mover's dollies.
- Durable Epoxy Powder Coat finish.

IW = Steel Wheel  
 SR = Soft Rubber Wheel

SKU NO.	MFG. NO.	SIZE	LOAD CAPACITY IN POUNDS
800145	23700	2"	150
800005	23714-2	2"	90
800155	21-25-IW	2½"	200
800065	23718-0	2½"	100
800160	23704-3	3"	300
800070	23720-3	3"	175
800170	21-4-IW	4"	400
800080	23736-4	4"	200
800175	21-5-IW	5"	500
800085	21-5-SR	5"	250
800185	21-6-IW	6"	650
800095	21-6-SR	6"	400

SKU NO.	MFG. NO.	SIZE	LOAD CAPACITY
800200	31-25-IW	2½"	200
800110	23772-2	2½"	100
800215	23756-2	3"	300
800115	23774-6	3"	175
800220	31-4-IW	4"	400
800125	23900-9	4"	200
800230	31-5-IW	5"	500
800130	31-5-SR	5"	250
800235	31-6-IW	6"	650
800140	31-6-SR	6"	400



**HEAVY DUTY CASTER**

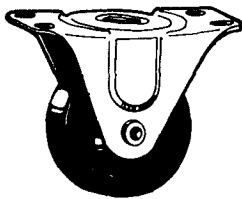

**RUBBER RIGID WHEEL**

SKU NO.	MFG. NO.	SIZE	LOAD CAPACITY IN POUNDS
800774	23770-8	2"	90

**RUBBER HEAVY DUTY CASTER**

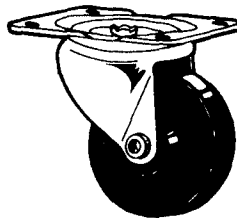

**SWIVEL WHEEL  
 300 LB. CAPACITY**

SKU NO.	MFG. NO.	SIZE	LOAD CAPACITY
800780	23716-6	2"	90
800783	23722-7	3"	175
800786	23738-8	4"	200

**OFFICE FURNITURE CASTER**

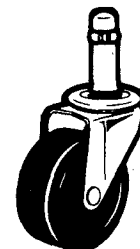

**2" RUBBER WHEEL  
 7/16" DIAMETER, STEM 1 1/8"  
 LONG TUBULAR METAL**

SKU NO.	MFG. NO.
800777	EW439R

**700 LB. CAPACITY DRUM CRADLE**

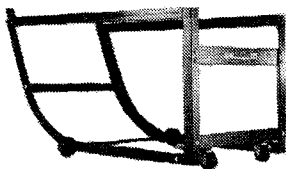

Medium weight economical one man transporting, lifting 30 or 55 gallon steel drums. Rim hook holds drum in place when lifting. Green Epoxy Powder Coat finish.

STEEL DRUM CRADLE WITH FOUR  
 2½" SEMI-STEEL WHEELS

SKU NO. 800245 ORDER NO. 51-IW

**DECORATIVE HOODED CASTER**



**2" RUBBER WHEEL  
 BRIGHT CHROME FINISH**

SKU NO.	MFG. NO.
800778	30423

**SAME AS ABOVE 1 3/8"  
 LONG WITH RING FOR  
 TUBULAR METAL.**

SKU NO.	MFG. NO.
800789	29390-2

**4**

# SHEPHERD CASTERS FOR MEDIUM AND LIGHT WEIGHT FURNITURE

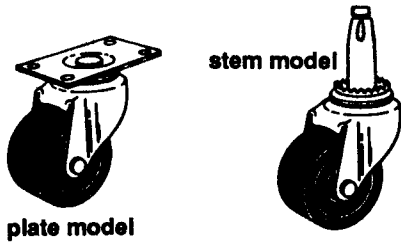

## Medium Duty Double Race Ball Bearing Wheel Casters

This classic caster, while popular for household furniture, has become an industry standard for wood base office furniture. Two ball bearing raceways allow instant swiveling. It has a black soft rubber wheel for smooth, silent operation on hard floors and chair mats.

- Two wheel sizes: 2" and 1 5/8"
- Color finish is Copper Oxide.
- With Rectangular Plate Fastening; 2" x 1 3/16" rectangular plate with 4 holes for use with wood screws.
- With Stem Fastening: 1 1/2" long, with 3/8" diameter socket.

**2" Rubber Wheel for medium weight furniture**—wood base cabinets, servers, office chairs and computer furniture, etc. Load rating 80 lbs. ea. Mounting height approx. 2 5/16".

SKU NO.	Catalog No.	Fastening
800681	9345	Stem
800684	9346	Plate

**1 5/8" Rubber Wheel for lighter weight furniture**—coffee and reception tables, small carts and servers, etc. Load rating 70 lbs. ea. Mounting height approx. 2 5/16".

SKU NO.	Catalog No.	Fastening
800687	9347	Stem
800690	9348	Plate

### FOR HARD FLOORS

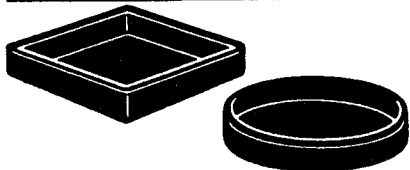

## Cushioned Rubber Cups

Round and square. Brown.

SKU NO.	Catalog No.	Style
800639	9074	Sm. Square
800642	9075	Sm. Round
800645	9076	Lg. Square
800648	9077	Lg. round

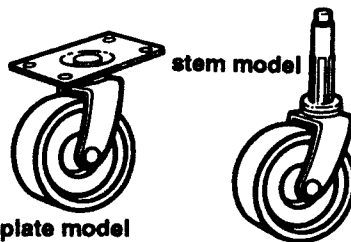

## Light Duty Swivel Bearing Furniture Casters

A low-cost caster for use on light weight household furniture on carpets and hard floors — small tables, cribs, play pens and other juvenile furniture.

- White plastic wheels in two sizes: 1 1/4" and 1 5/8" diameter
- Both swivel on acetal ring bearings.
- With Square Plate fastening: 1" x 1" with 4 holes for use with wood screws.
- With Stem Fastening: 1 1/2" long, with 3/8" diameter socket.

**1 1/4" Model**  
Load rating 50 lbs. ea.  
Mounting height approx. 1 5/8".

**1 5/8" Model**  
Load rating 60 lbs. ea.  
Mounting height approx. 2 3/16".

SKU NO.	Cat. No.	Fastening	Wheel dia.
800603	9052	Plate	1 1/4"
800609	9053	Stem	1 1/4"
800612	9054	Plate	1 5/8"
800606	9055	Stem	1 5/8"

## Medium Duty Swivel Bearing Furniture Casters



An economy caster for use on medium weight furniture on carpets and hard floors—coffee and bedside tables, servers, TV stands, microwave carts, etc.

- White 2" dia. plastic wheel with acetal ring bearing.
- Fastenings offered in rectangular Plate and Stem with socket.

Load rating 70 lbs. ea.  
Mounting height approx. 2 1/2".

SKU NO.	Catalog No.	Fastening
800615	9056	Stem

## Sockets for Tubular Furniture

Tough plastic sockets hold standard stem fastenings in tubular furniture.

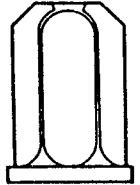

SKU NO.	Catalog No.	Tubing I.D.
800624	9064	1/2"
800627	9066	5/8"
800630	9069	3/4"
800633	9071	7/8"
800636	9073	1"

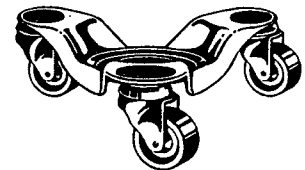

## Super Tri-Dollies

Because these handy dollies move heavy things easily, they have dozens of uses in homes, offices, shops, warehouses and institutions. They are especially useful in moving pianos, crates, heavy boxes, window air conditioners, desks, etc. (Not recommended on cushioned vinyl floors.) Tough polyolefin wheels swivel easily on steel ball bearings. Cushioned pads and a coated surface prevent scratching. Recessed center hole accommodates furniture legs. Two sizes: 6" and 12".

SKU NO.	Cat. No.	Size	Wheel Dia.	Load Rating
800678	9299	6"	1 1/4"	200 lbs.
800699	9442	12"	2"	300 lbs.



## Rubber Door Stop

Wedge shape. Brown.

SKU NO.	Catalog No.
808100	9132

## Swivel Nail-on Glide

For wooden legs. Non-rust white plastic base.



SKU NO.	Catalog No.
800651	9098

# SHEPHERD DECORATIVE BALL CASTERS

Color Finishes: Antique Copper, Bright Brass, Windsor Antique, Bright Chrome

With square plate Fastening - 1 1/2" square plate with 4 holes for use with No. 8 flat head wood screws - 1 1/2" model has 1 1/16" round plate.

With Stem Fastening - 1 1/2" long, with 3/8" diameter sockets.

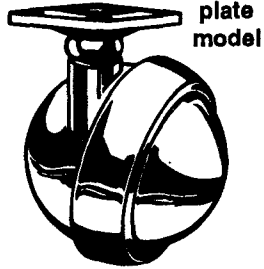

The first and finest ball caster made—known for its classic styling and outstanding mobility. Die cast of strong metal alloy, it has durability that carries a full 25 year warranty. It is self-lubricating (never needs oiling), swivels instantly and rolls smoothly. All moving parts are enclosed to stay free of lint, dust and foreign matter. Truly a superior quality caster for household and office furniture.

Metal wheel models are engineered for use on carpets.

Resilient wheel models have non-marking rubber or urethane treads for quiet movement on non-carpeted surfaces.

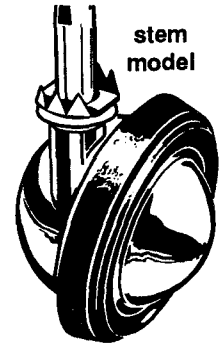

## Metal Wheel Models for Carpets

### 2 1/2" Metal Wheel

For heavy weight furniture: Sofas, upholstered chairs, beds, dressers, large cabinets, TV and stereo consoles, etc.

Load rating 100 lbs. ea. Mounting height approx. 3"

SKU NO.	Catalog No.	Fastening	Color Finish
800702	9301	Plate	Antique Copper
800705	9302	Stem	Antique Copper
800708	9303	Plate	Bright Brass
800711	9304	Stem	Bright Brass

### 2" Metal Wheel

### 2 1/4" Urethane Wheel

For medium weight furniture: Small sofas and upholstered chairs, TV stands, microwave carts, servers, etc.

Load rating 75 lbs. ea. Mounting height approx. 2 1/2"

Load rating 75 lbs. ea. Mounting height approx. 2 5/8"

SKU NO.	Catalog No.	Fastening	Color Finish
800714	9305	Plate	Antique Copper
800717	9306	Stem	Antique Copper
800720	9307	Plate	Bright Brass
800723	9308	Stem	Bright Brass

SKU NO.	Catalog No.	Fastening	Color Finish
800750	9317	Plate	Antique Copper
800753	9318	Stem	Antique Copper
800756	9319	Plate	Bright Brass
800759	9320	Stem	Bright Brass

### 1 1/2" Metal Wheel

### 1 5/8" Urethane Wheel

For light weight furniture: Coffee and bedside tables, cribs, carts, servers, foot stools, juvenile furniture, etc.

Load rating 40 lbs. ea. Mounting height approx. 1 3/4"

Load rating 30 lbs. ea. Mounting height approx. 1 3/4"

SKU NO.	Catalog No.	Fastening	Color Finish
800726	9309	Plate	Antique Copper
800729	9310	Stem	Antique Copper
800732	9311	Plate	Bright Brass
800735	9312	Stem	Bright Brass

SKU NO.	Catalog No.	Fastening	Color Finish
800762	9321	Plate	Antique Copper
800765	9322	Stem	Antique Copper
800768	9323	Plate	Bright Brass

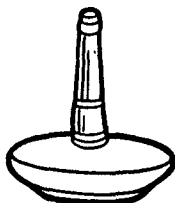

**Bed Glide**

Brass Finish; for metal bed frames.

SKU NO.	Catalog No.	Stem Dia.
800693	9351	3/8"

## Carpet Base Nail-on Glide

For wooden legs used on hard floor surfaces.

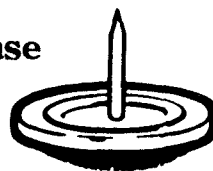

SKU NO.	Catalog No.	Size
800654	9103	1"

## Bed Frame Socket

Large plastic socket is specifically designed to accommodate bed glides.

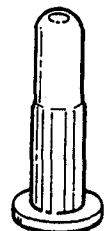

SKU NO.	Catalog No.
800696	9440

**POLYPROPYLENE ELASTIC STRETCH CORD – SPOOLS**

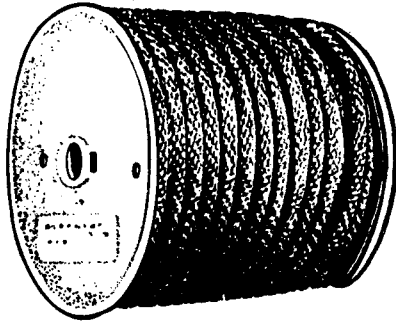

SKU NO.	CAT. NO.	SIZE	SHELF PACK
802759	A38T	5/16" x 164'	1
802762	A39T	3/8" x 164'	1

**MANILA ROPE**

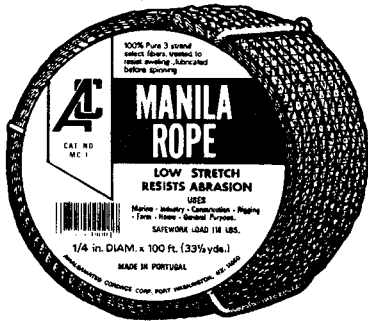

SKU NO.	CAT. NO.	SIZE DIA.	FT. PER COIL	APPROX. FEET PER LB.
802820	M111	1" x	600' coil	3.71'

**100% PURE MANILA REELS**



SKU NO.	CAT. NO.	SIZE DIA.	FEET PER REEL	APPROX. FEET PER LB.
802802	MR1	1/4" x	1200'	50'
802805	MR2	5/16" x	1200'	34.5'
802808	MR3	3/8" x	1200'	24.5'
802811	MR4	1/2" x	600'	18.33'
802814	MR5	5/8" x	600'	7.5'
802817	MR6	3/4" x	600'	6'

**SOLID BRAIDED NYLON ROPE – BULK SPOOLS**

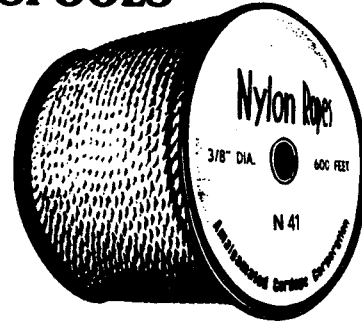

SKU NO.	CAT. NO.	SIZE	DIA.	FEET PER UNIT
802823	NB4	#4	1/8"	1000' Spool
802826	NB6	#6	3/16"	1000' Spool
802829	NB8	#8	1/4"	1000' Spool
802831	NB10	#10	5/16"	1000' Spool
802834	NB12	#12	3/8"	600' Spool
802837	NB16	#16	1/2"	500' Spool

**POLYPROPYLENE ROPE**



SKU NO.	CAT. NO.	SIZE DIA.	APPROX. FEET PER LB.	FEET PER REEL	SAFE WORK LOAD	TENSILE STRENGTH
802793	P2	1/4"	83.4'	1200'	113 lbs.	1130 lbs.
802796	P4	3/8"	35.7'	1200'	244 lbs.	2440 lbs.
802799	P6	1/2"	21.3'	1200'	420 lbs.	3780 lbs.

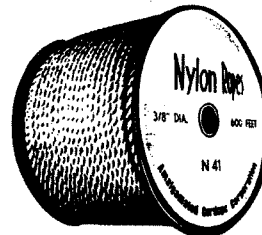

**STRANDED NYLON**

SKU NO.	Mfg. No.	Size
802839	N-21	1/4
802840	N-31	5/16
802843	N-41	3/8
802846	N-61	1/2
802849	N-71	5/8
802852	N-81	3/4

4

**JUTE TWINE**



SKU NO.	CAT. NO.	SIZE	SHELF PACK
802766	JT1	Natural 225' tube	6
802778	JTG1	Green 225' tube	6

**NYLON SEINE TWINE**

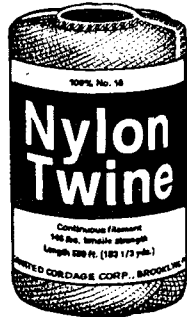

SKU NO.	CAT. NO.	SIZE	APPROX. FEET TO TUBE
802742	NT184	#18 — 1/4 lb.	275'
802745	NT214	#21 — 1/4 lb.	200'
802757	NT244	#24 — 1/4 lb.	165'
802751	NT188	#18 — 1/2 lb.	550'
802748	NT218	#21 — 1/2 lb.	400'

**ALL PURPOSE TWINE**



SKU NO.	CAT. NO.	SIZE	SHELF PACK
802775	PP45	400' ball Parcel Post Hvy	12

**CABLE CORD**

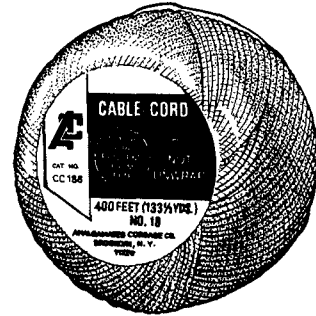

SKU NO.	CAT. NO.	SIZE	APPROX. FEET TO BALL
802784	CC184	#18 — 4 oz.	200'
802787	CC214	#21 — 4 oz.	180'
802790	CC218	#21 — 8 oz.	360'

**BIG BRONCO CLOTHESLINE**



SKU NO.	CAT. NO.	SIZE
802769	BCL75	#7 x 50'

**FLAPJACK CLOTHESLINE**



SKU NO.	CAT. NO.	SIZE
802772	FJ65	#6 x 50'

**POLYPROPYLENE SOLID BRAIDED CORD**



SKU NO.	CAT. NO.	SIZE
802776	PPBH7	#7 x 100'

**4**

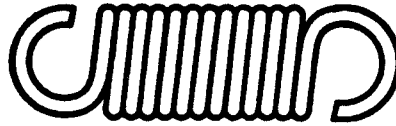

## EXTENSION SPRING

SKU NO.	MFG. NO.	SIZE	SKU NO.	MFG. NO.	SIZE	SKU NO.	MFG. NO.	SIZE	SKU NO.	MFG. NO.	SIZE
803216	C1	1/8" x 1 1/2"	803282	C111	3/16" x 2 1/2"	803213	C191	3/4" x 3 3/4"	803135	C269	1" x 7"
803219	C5	5/32" x 1 1/2"	803285	C115	1/4" x 2 1/2" x .016	803072	C193	3/8" x 4"	803138	C271	1 1/16" x 8 1/2"
803222	C7	3/16" x 1 1/2" x .02	803144	C117	1/4" x 2 1/2" x .020	803073	C201	3/16" x 5" x .023	803141	C273	1 1/8" x 8 1/2"
803225	C11	3/16" x 1 1/2" x .025	803147	C119	1/4" x 2 1/2" x .035	803075	C203	1/4" x 5"	803000	C275	1 1/8" x 7 1/2"
803228	C13	7/32" x 1 1/2"	803150	C131	7/16" x 2 1/2" x .028	803076	C205	1/4" x 5" x .034	803003	C277	3/4" x 6 1/2"
803231	C15	1/4" x 1 1/2" x .016	803153	C133	7/16" x 2 1/2" x .047	803078	C209	3/8" x 4 1/2"	803006	C281	3/8" x 5 1/2"
803232	C17	1/4" x 1 1/2" x .020	803156	C135	7/16" x 2"	803079	C211	3/8" x 4 1/2"	803009	C285	3/8" x 5"
803234	C19	1/4" x 1 1/2" x .035	803159	C139	7/16" x 3 1/2"	803081	C215	3/8" x 3 3/4"	803012	C287	5/16" x 5" x .031
803237	C23	9/32" x 1 1/2"	803162	C141	5/8" x 2 1/2"	803084	C219	15/32" x 4 1/2"	803015	C289	5/16" x 5" x .034
803238	C25	5/16" x 1 1/2"	803165	C143	9/16" x 3"	803087	C221	1/2" x 4 1/2"	803018	C293	3/8" x 6 3/4"
803240	C29	1 1/32" x 1 1/2"	803168	C155	5/16" x 3"	803090	C223	1/2" x 5"	803021	C301	1 1/2" x 11 1/2"
803243	C31	7/16" x 1 1/2" x .028	803171	C157	1/4" x 3 1/4"	803093	C227	1 1/16" x 4 3/4"	803024	C303	1" x 12"
803246	C33	7/16" x 1 1/2" x .047	803174	C161	7/16" x 2 3/4"	803096	C231	9/16" x 6"	803027	C307	1 1/16" x 12"
803249	C51	1/8" x 1 7/8" x .014	803177	C163	7/16" x 3 1/2"	803099	C233	1/4" x 6"	803030	C311	7/16" x 10 1/4"
803252	C55	5/32" x 1 7/8"	803180	C165	1/2" x 1 5/8"	803102	C235	5/16" x 6"	803033	C313	1/2" x 8 1/2"
803255	C63	7/32" x 1 7/8"	803183	C171	3/4" x 2"	803105	C239	3/8" x 6 1/2"	803036	C315	7/16" x 8 1/2"
803258	C67	1/4" x 1 7/8" x .020	803186	C173	3/4" x 2 1/4"	803108	C243	5/8" x 6 1/2"	803039	C317	5/8" x 8 1/2" x .091
803261	C69	1/4" x 1 7/8" x .035	803189	C175	3/4" x 2 7/16"	803111	C251	1 1/8" x 16"	803042	C319	9/16" x 8 1/2"
803264	C73	9/32" x 1 7/8"	803192	C177	3/4" x 2 5/8"	803114	C253	9/16" x 16 1/2"	803045	C321	5/8" x 1/2" x .062
803267	C77	1 1/32" x 1 7/8"	803195	C179	9/16" x 2 7/8"	803117	C257	13/16" x 4 1/2"	803048	C323	5/8" x 8 1/2" x .080
803270	C81	7/16" x 1 7/8" x .028	803198	C181	5/8" x 3 1/4"	803120	C259	13/16" x 4"	803051	C325	7/8" x 8 1/2" x .062
803273	C83	7/16" x 1 7/8" x .047	803201	C183	9/16" x 4"	803123	C261	1 1/16" x 5 1/2"	803054	C329	7/8" x 8 1/2" x .105
803276	C103	1/8" x 2 1/2"	803204	C185	3/4" x 3 1/2"	803126	C263	7/8" x 6"	803057	C333	7/8" x 9"
803279	C105	5/32" x 1 1/2"	803207	C187	3/4" x 2 7/8"	803129	C265	1 1/16" x 7"	803060	C337	1" x 8 1/2"
803280	C109	3/16" x 2 1/2"	803210	C189	3/4" x 3 1/8"	803132	C267	1 1/4" x 6 1/2"	803063	C339	1 1/4" x 10"



## COMPRESSION SPRING

SKU NO.	MFG. NO.	SIZE	SKU NO.	MFG. NO.	SIZE	SKU NO.	MFG. NO.	SIZE	SKU NO.	MFG. NO.	SIZE
803066	C500	5/32" x 9/16"	802973	C600	7/32" x 1 3/8" x .020	802883	C702	9/16" x 1"	802803	C804	1 1/4" x 4"
803069	C510	1/4" x 1 1/2"	802976	C604	7/32" x 1 3/8" x .023	802886	C704	1/2" x 1 1/2"	802806	C806	1 1/2" x 3 1/4"
802928	C516	5/32" x 1"	802979	C608	1/4" x 1 3/8"	802889	C706	9/16" x 1 3/8"	802812	C814	1 3/8" x 2 1/2"
802931	C520	3/16" x 7/8"	802982	C612	9/32" x 1 3/8"	802892	C712	1 1/16" x 1 1/4"	802809	C818	1 1/8" x 4" .120
802934	C526	3/16" x 1"	802985	C614	5/16" x 1 1/4"	802895	C714	3/8" x 2 1/4"	802815	C822	15/16" x 4"
802937	C530	7/32" x 1"	802988	C624	3/8" x 1 1/8"	802898	C720	1/2" x 1 3/4"	802818	C826	1" x 3 1/2"
802940	C532	3/16" x 1" x .013	802991	C632	7/16" x 1 1/16"	802901	C724	7/16" x 2"	802821	C830	1 1/8" x 3"
802943	C550	3/16" x 1" x .016	802994	C650	7/32" x 1 3/4"	802904	C730	13/32" x 2 3/4"	802824	C832	1" x 3"
802944	C552	7/32" x 1" x .016	802997	C652	7/32" x 1 3/8"	802907	C736	1/2" x 2 3/4"	802827	C834	1 3/16" x 2 3/4"
802946	C554	1/4" x 1"	802856	C660	5/16" x 1 3/4"	802910	C740	5/8" x 2 1/2"	802830	C836	7/8" x 4"
802949	C556	5/16" x 5/8"	802859	C664	1 1/32" x 1 1/2"	802913	C742	5/8" x 2 3/4"	802832	C838	3/4" x 3 1/2"
802952	C562	1/4" x 1"	802862	C668	3/8" x 1 1/2"	802916	C750	3/4" x 2"	802835	C850	5/8" x 5"
802955	C566	3/8" x 3/4"	802865	C672	3/8" x 1 3/4"	802919	C752	15/16" x 2"	802838	C856	3/4" x 6"
802958	C570	1/8" x 1 3/8"	802868	C676	7/16" x 2 1/8"	802922	C756	23/32" x 3 1/2"	802841	C858	1 1/16" x 6"
802961	C576	5/32" x 1 3/8"	802871	C680	5/16" x 2"	802925	C766	9/16" x 3"	802844	C864	7/8" x 6"
802964	C578	5/16" x 1 3/8" x .013	802874	C690	7/16" x 2 1/4"	802794	C782	5/8" x 3"	802847	C874	1 3/8" x 6"
802967	C580	3/16" x 1 3/8" x .028	802877	C692	5/8" x 1 1/2"	802797	C792	7/8" x 3"	802850	C878	5/8" x 9"
802970	C582	3/16" x 1 3/8" x .016	802880	C700	1/2" x 1"	802800	C802	1 3/8" x 4 3/8"	802853	C892	1 1/8" x 7"

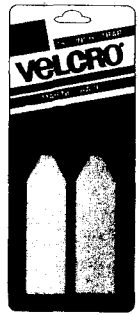

**VELCRO® BRAND  
CINCH STRAPS**  
 #90107 - Heavy Duty  
 2 Straps: 18 in.  
 Hold coiled items such  
 as hoses, ropes or cables.  
**SKU NO. 805201**



**VELCRO® BRAND  
FENDER STRAPS**  
 #90112 - Marine Grade  
 2 Straps: 36 in.  
 Hang protective fenders  
 from the railing, cleats, or  
 stanchions on your boat.  
**SKU NO. 806372**



**VELCRO® BRAND  
RUG AND MAT  
ANCHOR**  
 #90126 - 6 Sets Tape  
 1 Tube Glue:  
 3/8 fl. oz.  
 Keep area rugs and  
 car floor mats in place.  
**SKU NO. 805180**

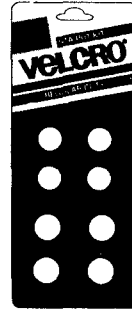

**VELCRO® BRAND  
STA-PUT KIT**  
 #90129 - Regular Duty  
 8 Sets  
 Secure hand tools and  
 decorative objects.  
**SKU NO. 805177**

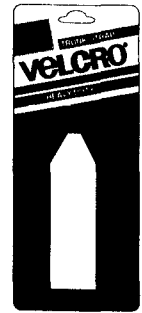

**VELCRO® BRAND  
TRUNK STRAP**  
 #90130 - 1 Strap: 32 in.  
 Secure car trunk lid when  
 carrying oversized loads.  
**SKU NO. 805207**



**VELCRO® BRAND  
CABLE CONTROL  
CLIPS**  
 #90096 - Heavy Duty  
 6 Sets  
**SKU NO. 806335**



**VELCRO® BRAND  
CABLE HOLD UPS**  
 #90097 - Heavy Duty  
 2 Straps: 15 in.  
 Secure coils of cable up  
 and out of the way.  
**SKU NO. 806332**



**VELCRO® BRAND  
HANG UP STRAPS**  
 #90115 - Heavy Duty  
 2 Straps: 18 in.  
**SKU NO. 805183**

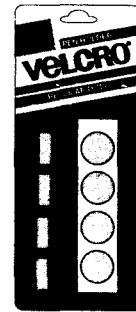

**VELCRO® BRAND  
PEN HOLDERS**  
 #90121 - 4 Sets  
 Attach a pen or pencil  
 to any surface.  
**SKU NO. 805210**

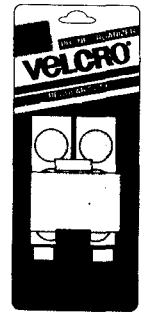

**VELCRO® BRAND  
PHONE ORGANIZER**  
 #90122 - 1 Pen Holder,  
 1 Note Clip,  
 4 Sets Coins,  
 2 Sets Tape

Organize your  
 telephone area.  
**SKU NO. 805204**

**VELCRO® BRAND BIG GRIP**

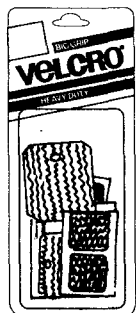

#90093 - 3 Sets  
 Heavy Duty  
 Secure tool handles,  
 mops and safety gear.

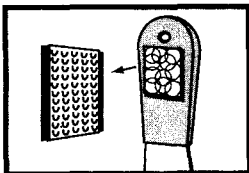

**SKU NO. 806339**

**VELCRO® BRAND  
ALL PURPOSE  
ADHESIVE**

#90065 - Tube, 1 fl. oz.  
 Use to attach Velcro® brand  
 products to difficult or rough  
 surfaces, where an extra strong  
 bond is desirable, or in areas  
 exposed to weather year round.  
**SKU NO. 805234**



**VELCRO® BRAND  
STICKY BACK® TAPE**



15 ft. long x 3/4 in.  
 wide

SKU NO.	MFG.	COLOR
805560	#90081	Black
805480	#90082	White
805720	#90083	Beige
805960	#90084	Navy
805800	#90085	Red

**VELCRO® BRAND GLUE-ON TAPE**

15 ft. long x 3/4 in.  
 wide

Glue-on to almost  
 any surface.

SKU NO.	MFG.	COLOR
805225	#90062	Black
805228	#90063	White
805231	#90064	Beige

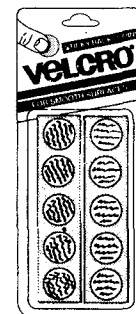

**VELCRO® BRAND  
STICKY BACK® COINS**

#90069 - 15 Sets - 5/8 in.  
 - Black

**SKU NO. 806357**

#90070 - 15 Sets - 5/8 in.  
 - White

**SKU NO. 806361**

Self-sticking - for small jobs.



**VELCRO® BRAND  
GLUE-ON TAPE**

#90134 - 18 in x 3/4 in.  
 - White  
 Marine Grade

Secure items such as flotation  
 cushions and stow gear on  
 rough or weather exposed  
 surfaces- forms a permanent  
 bond.

**SKU NO. 806353**

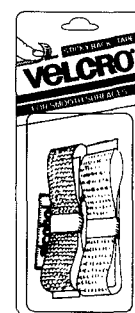

**VELCRO® BRAND  
STICKY BACK® TAPE**

#90078 - 18 in. x 3/4 in.  
 - Black

**SKU NO. 806364**

#90079 - 18 in. x 3/4 in.  
 - White

**SKU NO. 806368**

Self-sticking - mount items  
 without making holes.

**4**

**PLASTIC CHAIN**

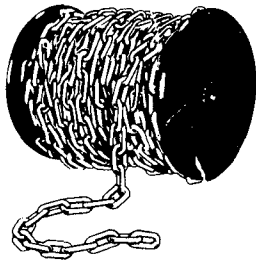

LARGE C LINKS, SIZE 2½" x 1¼'

SKU NO.	MFG. NO.	COLOR
805150	099-0847	#8 White
805153	099-0857	#8 Black

**STRAPPING KIT**

POLY STRAP PAK KIT  
 CONTAINS STRAPPING, BUCKLES,  
 HAND PULL TOOL IN SELF-  
 DISPENSING BOX

SKU NO. 455602 MFG. NO. PSP KIT



All Adjustable Stretch Cords are made with a double braid polyethylene cover, which provide substantial strength, abrasion and U.V. resistance. Polypropylene and nylon hooks resist marring finished surfaces.

SKU NO.	MFG. NO.	SIZE
805168	AH-36	36"
805569	AH-72	72"

SKU NO.	MFG. NO.	SIZE
805171	ASH36	36"

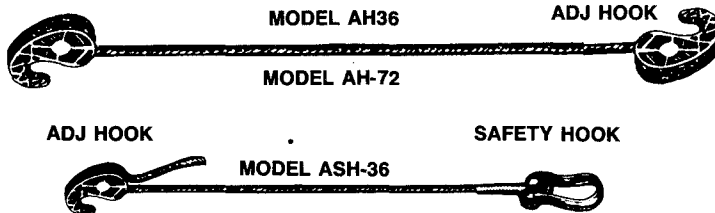

**A. LIFT RELEASE TIE-DOWN**

- Rugged adjustable buckle
  - 2" heavy webbing
  - Double J-hooks - approx. 5/16" diameter steel
  - Easy To adjust and release
  - Length adjustment range: 2' to 18'
  - Rated strength - 600 lbs. - loop load
- Rating is 1/5th actual breaking strength when new. Do Not Exceed Rated Strength.

SKU NO. 704647 ITEM NO. 5802

Packed One Per Poly Bag  
 Illustrations and instructions on Bag

**B. 1" RATCHET TIE-DOWN**

- Double J-Hooks with Keeper
  - Designed for quick and easy adjustment
  - 1" wide webbing
  - Length adjustment range 5845 - 2' to 12'
  - Rated strength - 600 lbs. - loop load
- Rating is 1/5th actual breaking strength when new. Do not exceed rated strength in actual use.

SKU NO. 704644 ITEM NO. 5845

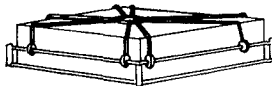

ABBOTT

**Rubber Tie-Down Straps**

Includes S-hooks attached at each end.

SKU NO.	Size	Span Range
751002	5"	10"-15"
751005	10"	15"-20"
751008	15"	20"-30"
751011	21"	30"-40"
751014	31"	40"-55"

**STEEL STRAPPING**

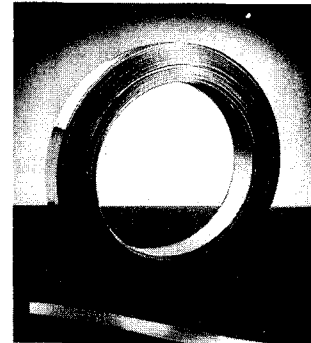

TENSIONER ½"

SKU No. 707440

CRIMPER ½"

SKU No. 707445

1/2" Steel Strapping .020 - 100lb.  
 SKU No. 805006

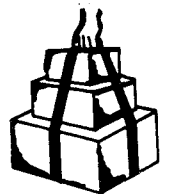

STRAP  
 05626-Yellow  
 05627-Black  
 05628-Blue  
 05629-Red

SKU NO. 704650

**Strap-Aid**

**Make A'Choice' Strap**

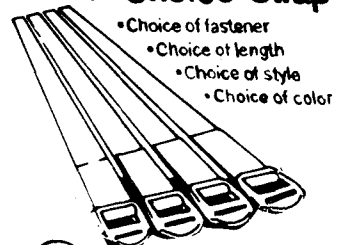

- Choice of fastener
- Choice of length
- Choice of style
- Choice of color



**Strap or Buckle**

SKU NO. 704650 MFG. NO. 05619



**No. 125 ROUND EYE BOLT SNAPS**  
 Nickel plated rust-proof metal

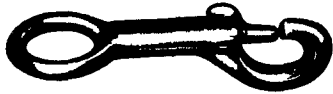

Size eye 5/8  
 Length overall 3-1/2  
 Snap opening 3/8  
 SKU NO. 804257

**DOUBLE PATTERN CHAIN SNAPS**  
 Nickel plated rust-proof metal



Number	162	163
Length overall	4	4-5/8
Snap opening	3/8	3/8

SKU NO.s 804260 804263

**No. 200 SQUARE LOOP SNAPS**  
 Nickel plated rust-proof metal



Size eye 5/8  
 Length overall 2-3/4  
 Snap opening 1/4  
 SKU NO. 804266

**No. 222 SWIVEL EYE SNAPS**  
 Nickel plated rust-proof metal



Size eye 5/8  
 Length overall 3-1/2  
 Snap opening 9/32  
 SKU NO. 804269

**No. 225 SWIVEL EYE BOLT SNAPS**  
 Nickel plated rust-proof metal

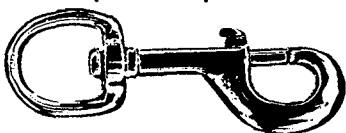

Size eye 3/4  
 Length overall 3-1/2  
 Snap opening 3/8  
 SKU NO. 804272

**BARON MANUFACTURING COMPANY**

**No. 435 SWIVEL ROLLER SNAPS**  
 Nickel plated rust-proof metal

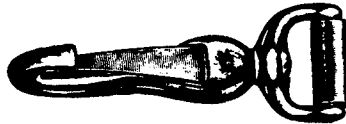

Size eye 1/2  
 Length overall 2-1/2  
 Snap opening 3/16  
 SKU NO. 804191

**No. 437 SWIVEL DOG LEAD SNAPS**  
 Nickel plated rust-proof metal



Size eye 3/8  
 Length overall 2-5/8  
 Snap opening 3/16  
 SKU NO. 804188

**No. 5013 SWIVEL TRIGGER SNAPS**  
 Nickel plated rust-proof metal



Size eye 5/8  
 Length overall 2-5/8  
 Snap opening 7/16  
 SKU NO. 804308

**OPEN EYE CHAIN SNAPS**  
 Cast malleable iron  
 Electro galvanized



Number	230	231
Size eye	3/8	3/8
Length overall	3-1/4	3-1/2
Snap opening	5/16	3/8

SKU NO.s 804278 804275

**No. 333 SECURITY SNAPS**  
 SWIVEL EYE  
 Cast malleable iron



Size eye 1  
 Length overall 5  
 Snap opening 1/2  
 SKU NO. 804281

**No. 2311 SNAP HOOK**  
 Cast malleable iron

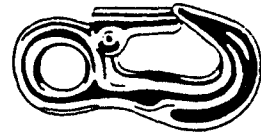

Size eye 5/8  
 Length overall 3-1/2  
 Snap opening 1/2  
 SKU NO. 804311

**No. 3141 SECURITY SNAPS**  
 RIGID EYE  
 Cast malleable iron



Size eye 3/4  
 Length overall 3-3/4  
 Snap opening 1/2  
 SKU NO. 804314

**OPEN SWIVEL EYE CHAIN SNAPS**  
 Zinc plated steel



Number	1406	1407	1408
Length overall	3-1/8	3-3/8	3-5/8
Snap opening	1/4	9/32	9/32

SKU NO.s 804299 804302 804305

**No. 2450 SPRING HOOKS**  
 Plated formed steel

Spring loaded interlocking snap for small boat, water skiing, mooring, motor safety line, etc.



Diameter stock	1/4	5/16	3/8
Length overall	2-1/2	3-1/8	4
Snap opening	5/16	3/8	1/2
Tensile lbs.	700	1,400	2,000

SKU NO.s 804284 804287 804290

Diameter stock	7/16	1/2
Length overall	4-3/4	6-3/8
Snap opening	5/8	1
Tensile lbs.	2,500	3,500

SKU NO.s 804293 804296

**4**

**No. 7350 QUICK LINKS**  
 Zinc plated steel

For quick connection of chain, cable and wire rope. No tools required. Easily tightened with fingers. Can be used over and over again. Has tensile of proof coil and BBB chain.

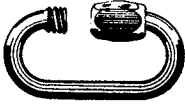

Trade size	1/8	3/16	1/4
Length overall	1-3/8	1-7/8	2-1/4
Jaw opening	3/16	1/4	9/32
Working Load Lt.	132	440	660
SKU NO.s	804245	804246	804251

Trade size	5/16	3/8
Length overall	2-15/16	3-1/8
Jaw opening	2-15/16	3-1/8
Working Load Lt.	1540	1760
SKU NO.s	804254	804404

Trade size	5/8	1/2
Length overall	5-1/2	4-1/8
Jaw opening	3/4	19/32
Working Load Lt.	4000	2860
SKU NO.s	804410	804407

**STEEL ROUND RINGS**  
 Nickel plated

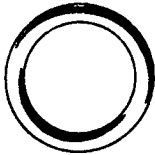

SKU NO.	Number	Inside Diameter Inches
804326	3	2

**BARON MANUFACTURING COMPANY**

**No. Z-7 ROUND RINGS**  
 Die Cast Rust-proof metal  
 Nickel or brass plated

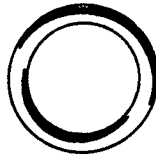

SKU NO.	Inside Diameter Inches	Diameter Stock
804323	1-1/2	8

**No. 1718 ROUND RINGS**  
 Drop forged alloy steel

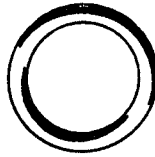

Inside diameter	2-1/4
Diameter stock	3/8
Proof load lbs	9,000
SKU NO.	804185

**No. 7 STEEL ROUND RINGS**

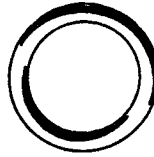

SKU NO.	Inside Diameter Inches
804317	1
804320	1-1/4

**No. 260 WIRE ROPE CLIPS**  
 Malleable iron base, steel bolts and nuts  
 Galvanized finish



SKU NO.	For Rope Size	Pcs. per Box
804194	1/8	25
804197	3/16	25
804200	1/4	25
804203	5/16	25
804206	3/8	25
804209	7/16	25
804212	1/2	25
804215	5/8	10
804218	3/4	10

**No. 264HG WIRE ROPE THIMBLES**  
 Standard pattern

To U.S. Fed. Spec. FF-T-276B Type II  
 Hot galvanized steel

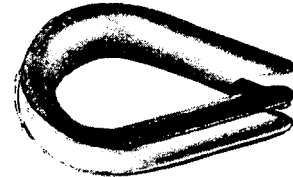

SKU NO.	For Rope Size	Overall Length	Inside Width
804221	1/8	1-13/16	11/16
804224	3/16	1-13/16	11/16
804227	1/4	1-13/16	11/16
804230	5/16	2-1/8	13/16
804233	3/8	2-1/2	15/16
804236	1/2	2-3/4	1-1/8
804239	5/8	3-1/2	1-1/4
804242	3/4	4	1-1/2

**FERRULES AND STOPS**

**WARNING: READ ALL WARNINGS BEFORE USING ANY FERRULES AND STOPS. ALWAYS USE DOOR PRODUCTS CABLE TOOLS TO APPLY FERRULES AND STOPS.**

MFG	DESCRIPTION	Icon
8010	1/16" ALUMINUM FERRULES. 100 PER BAG.	
SKU NO. 800512		
8011	1/16" ALUMINUM STOPS. 100 PER BAG.	
SKU NO. 800509		
8020	3/32" ALUMINUM FERRULES. 100 PER BAG.	
SKU NO. 800533		
8021	3/32" ALUMINUM STOPS. 100 PER BAG.	
SKU NO. 800536		
8030	1/8" ALUMINUM FERRULES. 100 PER BAG.	
SKU NO. 800518		

MFG	DESCRIPTION	Icon
8031	1/8" ALUMINUM STOPS. 100 PER BAG.	
SKU NO. 800539		
8040	5/32" ALUMINUM FERRULES. 50 PER BAG.	
SKU NO. 800521		
8041	5/32" ALUMINUM STOPS. 50 PER BAG.	
SKU NO. 800542		
8050	3/16" ALUMINUM FERRULES. 30 PER BAG.	
SKU NO. 800524		
8051	3/16" ALUMINUM STOPS. 30 PER BAG.	
SKU NO. 800548		
8060	1/4" ALUMINUM FERRULES. 20 PER BAG.	
SKU NO. 800527		
8061	1/4" ALUMINUM STOPS. 20 PER BAG.	
SKU NO. 800551		



7x7

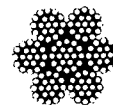

7x19



**PREFORMED VINYL COATED GALVANIZED AIRCRAFT CABLE\*  
 ON METAL DISPLAY REELS  
 7 x 7 and 7 x 19 CONSTRUCTION**

SKU NO.	Diameter Inches	Length in Feet	Construction	Width of Reel in Inches	Working Load Limit in Lbs.**	Minimum Breaking Strength in Lbs.**	Approx. Wt. Per Reel in Lbs.
804182	1/16-3/32	250	7x7	3	96	480	3.0
804170	3/32-3/16	250	7x7	3	184	920	8
804173	1/8-3/16	250	7x7	3	340	1700	10
804176	3/16-1/4	250	7x19	6	840	4200	21
804179	1/4-5/16	200	7x19	3	1400	7000	27

\* Not to be used in aircraft controls

\*\* Be familiar with the correct application



**PREFORMED WIRE ROPE -  
 IMPROVED PLOW STEEL BRIGHT  
 6 X 19 CLASS FIBER CORE  
 RIGHT REGULAR LAY**

SKU NO.	Diameter Inches	Breaking Strength in Lbs.**	Approx. Weight Lbs./Ft
804158	5/16	8520	0.164
804161	3/8	12200	0.236
804164	7/16	16540	0.32
804167	1/2	21400	0.42



**PREFORMED GALVANIZED  
 AIRCRAFT CABLE\*  
 7 X 7 CONSTRUCTION**

SKU NO.	Dia. Inches	Working Load Limit in Lbs.**	Breaking Strength in Lbs.**	Approx. Wt. Per 1000 Ft. in Lbs.
804146	1/16	96	480	7.5
804149	1/8	340	1700	28.5



**PREFORMED GALVANIZED  
 AIRCRAFT CABLE\*  
 7 X 19 CONSTRUCTION**

SKU NO.	Dia. Inches	Working Load Limit in Lbs.**	Breaking Strength in Lbs.**	Approx. Wt. Per 1000 Ft. in Lbs.
804152	3/16	840	4200	65
804155	1/4	1400	7000	110

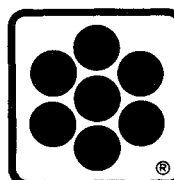
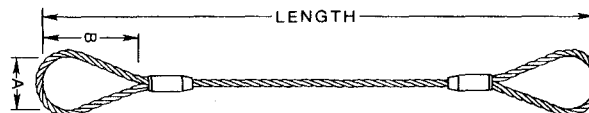

**LESCHEN**  
 Red-Strand WIRE ROPE

Eyes are formed using the flemish eye splice. Ends are secured by pressing a metal sleeve, either steel or aluminum, over the ends of the strands of the splice. Pull is directly along the centerline of rope and eye. Gives most efficient use of rope capacity, is economical.

**ALUMINUM CLOTHES LINE 50 FT COIL**

SKU# 417899 MFG# CL100

SKU NO.	ROPE DIAM.	EYE DIMENSION		LENGTH FT.
		A	B	
800554	1/4"	2"	4"	4
800557	1/4"	2"	4"	6
800563	1/4"	2"	4"	8
800566	3/8"	3"	6"	4
800569	3/8"	3"	6"	6
800572	3/8"	3"	6"	8
800578	1/2"	4"	8"	4
800581	1/2"	4"	8"	6
800584	1/2"	4"	8"	8

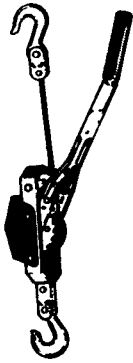

**1 TON**

The popular, wide-utility models - 6 Ft. pull weighs only 7 1/2 lbs. - 12 ft. pull weighs 8 lbs. Standard compact, rugged frame is 8 1/4" long x 2 1/4" wide. Minimum distance between hooks is 18". Has 18:1 power ratio; will handle 2000 lbs. easily.

SKU NO.	MFG. NO.	CAPACITY	PULL
700532	MM112R	1 Ton	12 FT.

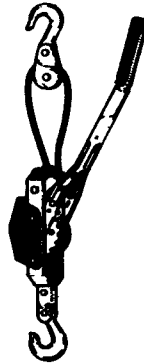

**2 TON SINGLE DRIVE**

This heavy-duty two ton model weighs only 8 1/2 lbs. complete with cable and hook. Compact, ruggedly constructed frame is 8 1/4" long x 2 1/4" wide. Minimum distance between hooks is 20". Has 36:1 power ratio. Will easily handle 4000 lbs.

SKU NO.	MFG. NO.	CAPACITY	PULL
700533	MM212R	2 Tons	6 FT.

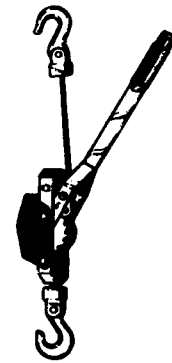

**1/2 TON**

Now, an industrial grade tool designed and priced for personal use. Simplified release control of drive pawls for raising or lowering. Unique design allows Clevis a full 360 degree rotation. Brake cable spring fabricated for easy in-field maintenance.

SKU NO.	MFG. NO.	PULL
700527	MM5014	14 FT.
700529	MM5028	28 FT.

4

**MINI WIRE CLAMP MODEL MP 189**

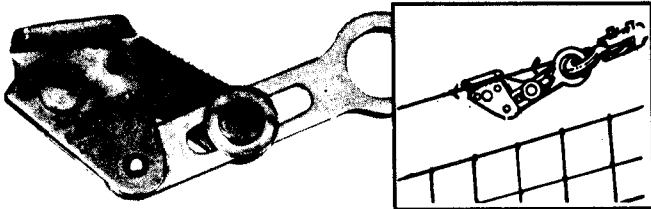

Designed for use with a Mini-Mule puller, it is an essential accessory for barbed, smooth or insulated wire from 1/16" to 1/4" diameter. The Mini Wire Clamp weighs only 15 oz., yet has a capacity of 1300 lbs. Provides a sure, positive grip.

SKU ON. 701699

**ADJUSTABLE CHAIN SLING**

MODEL MP 506

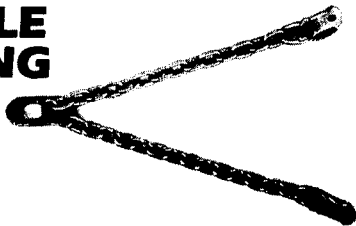

For lifting motors from cars, trucks, tractors and boats. Can be locked with long and short legs to hold a motor at proper angle for installation or removal. Capacity 2350 lbs. A bolt through the anchor lugs converts it to an excellent anchor loop for vertical lifting, horizontal pulling, stretching or positioning.

SKU NO. 700569

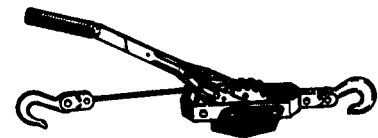

**2 TON HEAVY-DUTY, DOUBLE DRIVE**

Revolutionary design and engineering make this the most rugged, reliable and safe puller for today's industrial requirements. Ratchet wheels on both sides for a balanced drive. Double locking and driving pawls independently sprung to insure alignment with ratchet wheel teeth. Tubular steel cable guide guards against excessive wear or fraying. Two legs transfer load to cable drum, minimize distortion and binding locking and lifting pressure applied uniformly to both sides of cable drum.

SKU NO.	MFG. NO.	CAPACITY	PULL
700566	MM112DD	1 Ton	12 FT.
700568	MM212DD	2 Ton	6 FT.

**GRADE 30 PROOF COIL**



A general utility chain for farm, industry and home applications such as; pulling stumps, log chain, cargo lashing, pipe line hanging, tailgate, guard rail, tow and switch chain.  
**MATERIAL** — Low Carbon steel.

**REELS**

SKU NO.	BRIGHT ZINC STOCK NO.	TRADE SIZE INCHES	CROSS WT. PER WT. PER	FT. PER FT. PER
804065	014-0323	3/16"	42	100
804068	014-0423	1/4"	51	75
804071	014-0523	5/16"	71	70
804074	014-0623	3/8"	59	40

**FULL DRUM**

SKU NO.	BRIGHT ZINC STOCK NO.	TRADE SIZE INCHES	FT. PER DRUM
804122	014-0823	200	1/2"

**GRADE 40 HIGH TEST**



Grade 40 Chain features both high tensile strength and resistance to wear needed by modern hauling and heavy duty trucking, farm and construction firms. Working load limits exceed those of ordinary low carbon or general utility chain.  
**MATERIAL** — Carbon steel.

**REELS**

SKU NO.	BRIGHT STOCK NO.	TRADE SIZE INCHES	CROSS WT. PER REEL LBS.	FT. PER REEL
804056	018-1413	1/4"	58	75
804059	018-1513	5/16"	79	70
804062	018-1613	3/8"	64	40

**GRADE 70 TRANSPORT CHAIN**



Grade 70 is extremely strong for its light weight and is used primarily for load binding in the transportation industry. However, it is also used extensively on farms, in lumbering, towing and construction. Grade 70's high strength to weight ratio is achieved due to the boron manganese steel from which it is fabricated. It resists wear because of its exceptional hardness properties.  
**MATERIAL** — Boron Manganese steel.

**HALF DRUMS**

Grade 70 is approved by the Department of Transportation for truck tiedown use. Acco Grade 70 meets all applicable State requirements.

SKU NO.	BLACK LACQUERED FINISH STOCK NO.	TRADE SIZE INCHES	FT. PER 1/2 FIBRE DRUM
804125	051-0613	3/8"	200

**MACHINE CHAIN**



Machine chain is a short link, welded chain for general use where compactness and extra flexibility are desired. It is available in both straight and twist link. It is generally used on tailgates, agricultural implements and industrial equipment.  
**MATERIAL** — Low Carbon steel.

**REELS**

**STRAIGHT LINK**

SKU NO.	BRIGHT ZINC STOCK NO.	BRASS PLATED STOCK NO.	FT. PER REEL	WT. PER REEL
804101	072-6727	—	125	20
804104	072-3367	4603-60318	80	16
804118	072-1620			
804119	072-1660			

**COIL CHAIN**



Coil Chain has longer links than machine chain. Uses include: animal tie chains, agricultural implement chains, platform barrier or guard chains, etc.  
**MATERIAL** — Low Carbon steel.

**REELS**

**STRAIGHT LINK**

SKU NO.	BRIGHT ZINC STOCK NO.	FT. PER REEL	WT. PER REEL
804092	033-2033	125	36



**TWIST LINK**

SKU NO.	BRIGHT ZINC STOCK NO.	FT. PER REEL	WT. PER REEL
804098	072-2527	75	28

**PASSING LINK CHAIN**



The wide design of this chain permits links to pass one another freely, minimizing kinking and tangling. It is used extensively for animal ties, farm machinery and general utility on farms and in industry.  
**MATERIAL** — Low Carbon steel.

**CARTONS**

SKU NO.	BRIGHT ZINC STOCK NO.	FT. PER CTN.
804089	072-2927	100

**TENSO CHAIN**



A general utility chain for hardware and manufacturing applications such as — playground and gym equipment, fluorescent lights, boats, gates, porch swings, halter, kennel, dog runner, cow ties and tie-out chains.  
**MATERIAL** — Low Carbon steel.

**REELS**

SKU NO.	BRIGHT ZINC STOCK NO.	FT. PER REEL	WT. PER REEL
804083	072-3227	200	14
804086	072-0127	250	25
804077	075-2023	175	33

**JACK CHAIN**



A light duty wire chain for such uses as suspending flower pots, scales and children's toys.

**REELS**

**SINGLE JACK**

SKU NO.	BRIGHT ZINC STOCK NO.	FT. PER REEL	WT. PER REEL
804113	072-4027	250	7
804110	072-1727	100	10



**DOUBLE JACK**

SKU NO.	BRIGHT ZINC STOCK NO.	FT. PER REEL	WT. PER REEL
804116	2608-21615	200	9
804119	2608-61615	200	9

4

**LOAD BINDERS**

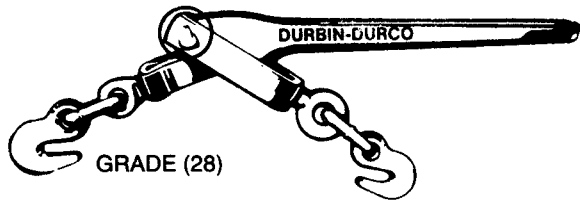

**REGULAR SERIES  
B1-S DIXIE**

7/16"-1/2" proof coil binder. Economical but durable, used for tying down equipment and machinery. Forges snub nose hooks, forged swivels for easy load securement. Equipped with patented Clevis Lok™

SKU NO.	Mfg. No.	Maximum Chain Size	Working Load Limit	Ultimate Strength
804491	01001	3/16" - 1/4"	1,250 lbs.	5,000 lbs.
804494	01002	1/4"-3/8"	2,650 lbs.	10,600 lbs.
804497	01003	3/8"-1/2"	4,500 lbs.	18,000 lbs.

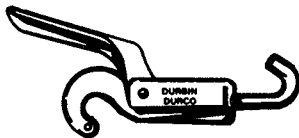

**MY T ATOM  
4/0 MACHINE CHAIN**

**UTILITY CHAIN BINDERS  
Clevis Hook Swivels**

Clevis Hook Swivels. All Steel—Stamped.

**Ideal Uses:** Chaine and cable tightener, binding load on trucks, fastening end gates, keep truck stakes form spreading; bulging. Formed J Hook for quick and easy release.

SKU NO.	Mfg. No.	Maximum Chain Size	Working Load Limit	Ultimate Strength
804485	01005	3/16"	250 lbs.	1,000 lbs.
804488	01006	3/16"	375 lbs.	1,500 lbs.

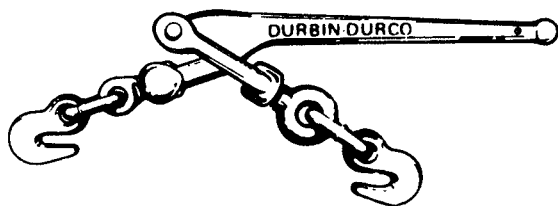

**DROP FORGED SERIES**

American made for hauling steel heavy equipment, construction work. Industrial users. Great all-purpose binder made to endure. Heavy duty forged steel handle, swivels and sockets. Heat treated alloy steel hooks forged clevis and tongue.

SKU NO.	Mfg. No.	Maximum Chain Size	Working Load Limit	Ultimate Strength
805276	01011	7/16"-5/8"	11,500 lbs.	37,000 lbs.

**RATCHET BINDERS**

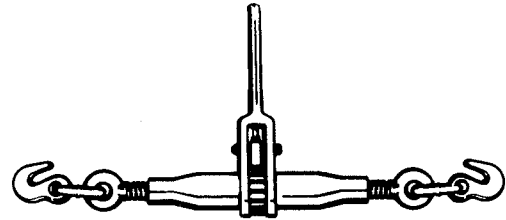

**SWAGE BARREL**

These turnbuckle type load binders offer the advantage of continuous take-up feature and infinite adjustment gets the last half link of chain. The push-pull ratchet action and double-acting, spring-loaded pawl permit easy one-man operation without kickbacks. Pinpoint setting for tension. Permanently locked at all times.

SKU NO.	Mfg. No.	Maximum Chain Size	Working Load Limit	Ultimate Strength
804503	01045	1/4"-3/8"	6,600 lbs.	19,800 lbs.
804500	099312	3/8"-1/2"	9,200 lbs.	27,600 lbs.

**EYE HOOKS**



**EYE GRAB**

**GALVANIZED GRAB HOOK (EYE)**

SKU NO.	Mfg. No.	Size
804461	72191	1/4"
804464	72291	5/16"
804467	72391	3/8"
804470	71493	7/16"
804473	71591	1/2"
804329	71693	5/8"
804332	M212HZ	3/4"



**EYE SLIP**

**GALVANIZED EYE SLIP HOOK**

SKU NO.	Mfg. No.	Size
804377	76191	1/4"
804380	76291	5/16"
804383	76391	3/8"
804389	75591	1/2"

4

**GALVANIZED GRAB HOOK CLEVIS**

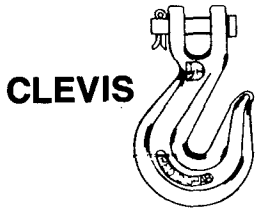

**CLEVIS HOOKS**

SKU NO.	Mfg. No.	Size
804359	#62193	1/4"
804365	#62393	3/8"
804371	#61593	1/2"
804374	#M810ZL	5/8"
804362	#62293	5/16"

CLEVIS GRAB

**GALVANIZED CLEVIS SLIP HOOK**

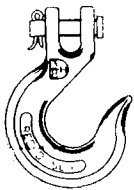

SKU NO.	Mfg. No.	Size
804508	#67193	1/4"
804510	#67293	5/16"
804511	#67393	3/8"
804513	#66593	1/2"

CLEVIS SLIP

**GALVANIZED CHAIN SWIVEL**

SKU NO.	Mfg. No.	Size
804395	#85982	1/4"
804398	#89584	3/8"
804401	#89585	1/2"

**CHAIN CONNECTING LINKS**

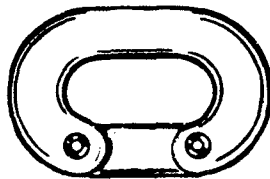

**QUICK LINKS**

**Electro-Galvanized, Proof Coil Grade (28)**

Connects instantly by simple tightening with wrench. Can be used repeatedly. Threaded connector permits easy closing and reopening. Designed for quick repair of chain links or for adding hooks and fittings to chain.

SKU NO.	Mfg. No.	Size
804335	#M613G	3/16"
804341	#M615G	5/16"
804344	#M616G	3/8"
804350	#M618G	1/2"
804353	#M620G	5/8"
804356	#M622G	3/4"



**REPAIR OR LAP LINKS E.G. Steel, Proof Coil Grade (28)**

For temporary use of proof coil chain and for use with couplings and other attachments.

SKU NO.	Mfg. No.	Size
804440	#580-0024	1/8" x 3/4"
804443	#84091	3/16" x 1"
804446	#84291	1/4" x 1/4"
804449	#84591	5/16" x 1 1/2"
804452	#84791	3/8" x 1 5/8"
804455	#84991	1/2" x 2 1/2"

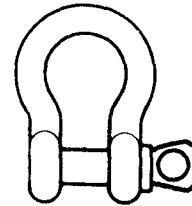

**ANCHOR SHACKLES FORGED ANCHOR SHACKLES**

Screw pin type — Forged steel shackles that feature an open-throat design that permits free line movement without undue wear. Wide bow allows simple clearance for thimbles and turnbuckles. Screw pin shackle require no special tools to assemble. Simply slip screwdriver blade or hand punch through pin and eye and tighten.

SKU NO.	Mfg. No.	Size
804413	#MC645G	3/16"
804416	#MC646G	1/4"
804419	#MC647G	5/16"
804422	#MC648G	3/8"
804425	#MC650G	1/2"
804428	#MC651G	5/8"
804431	#MC652G	3/4"
804434	#MC653G	7/8"
804437	#MC654G	1"

**HOIST**



**WELL WHEELS**

Steel shell and swivel wire formed hook. For lifting loads up to 250 pounds, using synthetic rope.

SKU NO.	Mfg. No.	Wheel Size
804479	13405	10"
804482	13406	12"

**4**

SINTERED BRONZE BEARINGS SELF ALIGNING

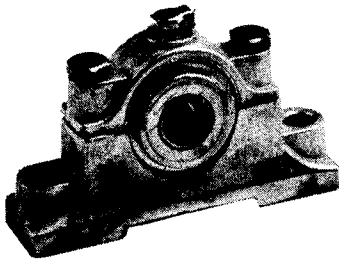

SKU NO.	Stock No.	Shaft Diam.	Bolt Size	Net Wt.
805106	7-500-5	1/2"	1/16"	8 oz.
805109	7-500-6	5/8"	1/16"	8 oz.
805112	7-500-7	3/4"	1/16"	8 oz.

SINTERED BRONZE JOURNAL BEARINGS

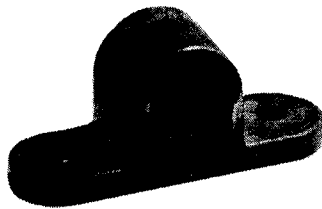

SKU NO.	Stock No.	Shaft Diam.	Bolt Size	Net Wt.
805115	704	3/8"	1/16"	2 oz.
805118	705	1/2"	1/4"	4 oz.
805121	706	5/8"	1/4"	5 oz.
805124	707	3/4"	1/4"	5 oz.

BALL BEARINGS

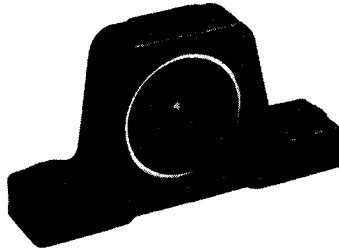

SKU NO.	Stock No.	Shaft Diam.	Bolt Size	Net Wt.
805097	6-700-5	1/2"	1/16"	9 oz.
805100	6-700-6	5/8"	1/16"	9 oz.
805103	6-700-7	3/4"	1/16"	9 oz.



Universal joints can be furnished drilled or tapped at a slight increase in price with production quantities.

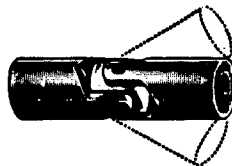

UNIVERSAL JOINTS

SKU NO.	Stock No.	Bore Diam.	Out-side Diam.	Over-all Length	Length of Bore	Net Wt. Ozs.
805079	4004	1/4"	1/16"	2"	1/16"	1 1/2
805082	4005	1/8"	1/16"	2"	1/16"	1 1/2
805085	4006	3/8"	13/16"	2 3/8"	3/8"	4
805088	4008	1/2"	13/16"	2 3/8"	3/8"	4
805091	4010	5/8"	1 1/8"	3 1/4"	13/16"	8
805094	4012	3/4"	1 1/8"	3 1/4"	13/16"	8

SLEEVE COUPLINGS

All couplings are furnished with set screws.

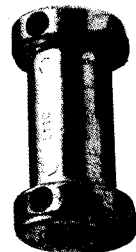

SKU NO.	Stock No.	Bore Diam.	Out-side Diam.	Length	No. of Set Screws	Net Wt. Ozs.
805184	5008	1/2"	1"	2"	2	2 1/2
805187	5010	5/8"-3/4"	1 3/8"	2 3/4"	4	8

**Chicago**  
**DIE CASTING MFG. CO.**

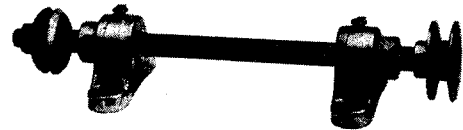

SKU NO. No. 440 SINTERED BRONZE BEARING  
 805160 Shaft Length 12" Pulley Diam. 2"  
 Shaft Diam. 3/4" V-Belt Size "A" Sec.  
 Threaded End 1/2" L.H.

SKU NO. No. 990  
 805163 Shaft Length 12" Pulley Diam. 2"  
 Shaft Diam. 3/4" V-Belt Size "A" Sec.  
 Threaded Ends 3/8" L.H.



PRECISION  
 BALL BEARINGS

SKU NO.	No.	Shaft Length.	Diam.	Threaded End	Wt.
805178	1550	10"	3/4"	1/2" L.H.	3 lbs.
805181	1560	10"	3/4"	3/4" L.H.	3 lbs.

Pulley 2" "A" Sec.



SKU NO. No. 550 SINTERED BRONZE BEARING  
 805166 Shaft Length 8" Pulley Diam. 2" x 2 1/4"  
 Shaft Diam. 3/4" V-Belt Size "A" Sec.  
 Threaded Ends 1/2" R. & L.



SKU NO. No. 330 SINTERED BRONZE BEARING  
 805169 Shaft length 12" Pulley Diam. 2"  
 Shaft Diam. 3/4" V-Belt Size "A" Sec.  
 Threaded Ends 1/2" R. & L.

805172 No. 220  
 Shaft Length 12" Pulley Diam. 2"  
 Shaft diam. 3/4" V-Belt Size "A" Sec.  
 Threaded End 3/8" R. & L.

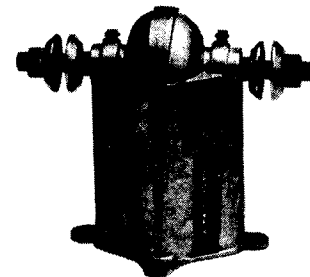

SKU NO. No. 888 SINTERED BRONZE BEARING  
 805175 Shaft Length 7 1/2" Pulley diam. 2"  
 Shaft Diam. 3/4" V-Belt Size "A" Sec.  
 Threaded Ends 1/2" R. & L.

4



**Chicago**  
**DIE CASTING MFG. CO.**

**A SECTION**

For 4L or ½" x 11/32" belts.

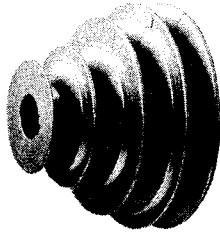

**V-GROOVE STEP PULLEYS (A SECTION)**

MFG. NO.	NO. OF STEPS	DIAMETER OF BORE		
		½"	⅝"	¾"
113	2	804887	804890	
140	4	804944	804947	804950
141	4	804953	804956	804959
142	4	804962	804965	804968
143	4	804971	804974	804977
144	3	804908	804911	804914
145	3	804899	804902	804905
146	3	804917	804920	804923
147	4	804980	804983	804986
148	3	804935	804938	804941
149	3	804926	804929	804932
150	2	804893	804896	

**A SECTION**

For ½" x 11/32" belts.

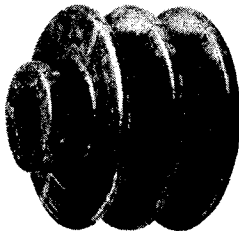

**MULTIPLE DRIVE (A SECTION)**

MFG. NO.	OUTSIDE DIAM.	DIAMETER OF BORE		
		½"	⅝"	¾"
130	2½"	804989	804992	804995
131	3"	804998	805001	805004

**A SECTION**



**VARIABLE SPEED PULLEYS**

MFG. NO.	OUTSIDE DIAM.	DIAMETER OF BORE	
		½"	⅝"
325	3¼"	805007	805010

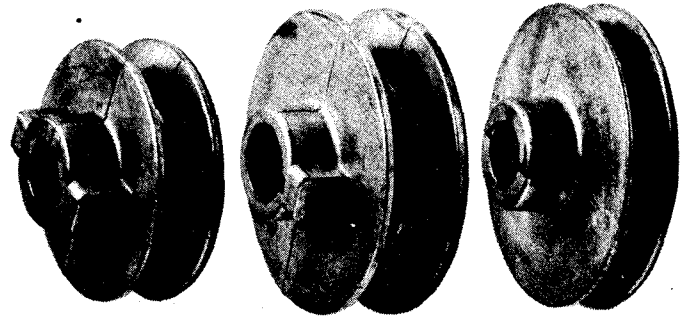

**A SECTION**

For 4L or ½" x 11/32" belts.

**B SECTION**

For 5L or 21/32" x 7/16" belts.

**O SECTION**

For 3L or 3/8" x 1/4" belts.

**SINGLE "V" GROOVED PULLEYS**

MFG. NO.	OUTSIDE DIAM.	DIAMETER OF BORE				
		⅜"	½"	⅝"	¾"	1"
150-A	1½"	800339	803318			
150-O	1½"	805028	805031			
175-A	1¾"	803432	803669	803672	803675	
200-A	2"	803678	803681	803684	803687	
200-B	2"		804809			
200-O	2"	805034	805037	805040		
225-A	2¼"	803690	803693	803696	803699	
225-B	2¼"		804812			
250-A	2½"	803702	803705	803780	804080	
250-B	2½"		804815	804818	804821	
250-O	2½"	805043	805046	805049		
275-A	2¾"	804653	804656	804659	804662	
275-B	2¾"		804824	804827	804830	
300-A	3"		804665	804668	804671	
300-B	3"		804833	804836	804839	
300-O	3"	805052	805055	805058		
325-A	3¼"		804674	804677	804680	
325-B	3¼"		804842	804845	804848	
350-A	3½"		804683	804686	804689	
350-B	3½"		804851	804854	804857	
350-O	3½"	805061	805064	805067		
400-A	4"		804692	804695	804698	
400-B	4"		804860	804863	804866	
400-O	4"	805070	805073	805076		
450-A	4½"		804701	804704	804707	
500-A	5"		804710	804713	804716	
500-B	5"		804869	804872	804875	
550-A	5½"		804719	804722	804725	
600-A	6"		804728	804731	804734	
600-B	6"		804878	804881	804884	
700-A	7"		804737	804740	804743	
800-A	8"		804746	804749	804752	804755
900-A	9"		804758	804761	804764	804767
1000-A	10"		804773	804788	804779	804782
1200-A	12"		804785	804776	804791	804794
1400-A	14"		804797	804800	804803	804806

4



**DIE CAST SHAFT COLLARS**

\*Furnished with hollow head set screw. All shaft collars are furnished with slotted headless set screws. Special screws may be had at a slight increase in price with production quantities.



SKU NO.	Stock No.	Bore Diameter	Outside Diameter	Width	Set Screw Size	Net Weight
805127	3003*	3/16"	9/16"	3/8"	10-24 Thread	62 to 1 lb.
805130	3004*	1/4"	5/8"	11/32"	10-24 Thread	53 to 1 lb.
805133	3005*	5/16"	11/16"	11/32"	10-24 Thread	44 to 1 lb.
805136	3006*	3/8"	3/4"	11/32"	10-24 Thread	41 to 1 lb.
805139	3008	1/2"	1"	1/2"	5/16-18 Thread	1 oz.
805132	3010	5/8"	1-1/8"	1/2"	5/16-18 Thread	1 1/2 oz.
805142	3012	3/4"	1-1/4"	1/2"	5/16-18 Thread	2 oz.
805145	3014	7/8"	1-3/8"	5/8"	5/16-18 Thread	2 oz.
805148	3015	15/16"	1-9/16"	3/4"	5/16-18 Thread	3 1/2 oz.
805154	3100	1"	1-5/8"	3/4"	5/16-18 Thread	3 1/2 oz.

**4**

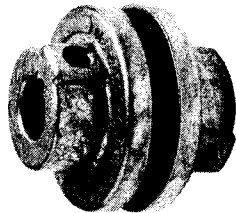

**FLEXIBLE COUPLINGS**

MFG. NO.	OUTSIDE DIAM.	DIAMETER OF BORE			
		3/8"	1/2"	5/8"	3/4"
110	2 1/8"		805019	805022	805025
406	1 7/8"	805016	805013		

#K695 CHAIN ROLLER KIT		CONNECTING LINK <small>Used with an even number of pieces</small>	OFF SET <small>Used with an odd number of pitches</small>	JANDORF <small>4111 Primrose Avenue, Baltimore, Md. 21215</small>	
#35OF Pkg/4  SMALL OFFSET LINK	#43OF Pkg/4  1/2" x 1/8" SMALL OFFSET LINK	#41OF Pkg/4  MEDIUM OFFSET LINK	#40-OF Pkg/4  MEDIUM OFFSET LINK	#420-OF Pkg/4  MEDIUM OFFSET LINK	#50-OF Pkg/4  LARGE OFFSET LINK
#35CL Pkg/12  SMALL CONNECTING LINK	#43CL Pkg/12  SMALL CONNECTING LINK	#41CL Pkg/12  MEDIUM CONNECTING LINK	#40CL Pkg/8  MEDIUM CONNECTING LINK	#420CL Pkg/8  MEDIUM CONNECTING LINK	#50CL Pkg/8  LARGE CONNECTING LINK

This High Quality ANSI STANDARD RIVETED ROLLER CHAIN Factory Pre-Stretching Shot Peened Parts PrepStretching Is Done To Every Link Of Farm-Test Chain. This is Done At The Factory As A Regular Process To Eliminate Initial Stretch. Every Pin, Bushing, Roller And Side Plate Is Shotpeened During Production. This Process Increases Metal Fatigue Resistance.

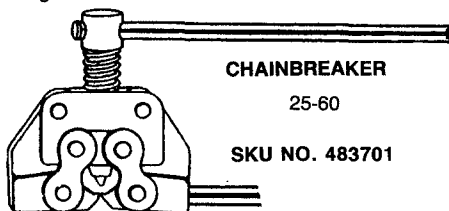

**ROLLER CHAIN**

SKU/FT	CHAIN NO.
483347	ANSI 35 Roller Chain
483354*	ANSI 40 Roller Chain
483370	ANSI 50 Roller Chain
483388	ANSI 60 Roller Chain

SKU NO.	MFG. NO.	ITEM
809330	#89421	Small offset chain links
809348	#89420	Connecting link #35
809339	#89551	Offset chain link #40
809357	#89581	Connecting link #40
809336	#89614	Offset chain link #41
809354	#89613	Connecting link #41
809342	#89616	Offset chain link #420
809360	#89622	Connecting link #420
809333	#89672	Offset chain link 1/2 x 1/8
809351	#89670	Connecting link #43
809345	#89769	Offset chain link #50
809363	#89824	Connecting link #50



**V-BELTS**

$\frac{3}{8}'' \times \frac{7}{32}''$			$\frac{1}{2}'' \times \frac{5}{16}''$					
SKU NO.	MFG NO.	LENGTH	SKU NO.	MFG NO.	LENGTH	SKU NO.	MFG NO.	LENGTH
114710	3L160	16"	115048	4L170	17"	115428	4L550	55"
114736	3L180	18"	115055	4L180	18"	115436	4L560	56"
114744	3L190	19"	115063	4L190	19"	115444	4L570	57"
114751	3L200	20"	115071	4L200	20"	115451	4L580	58"
114769	3L210	21"	115089	4L210	21"	115469	4L590	59"
114777	3L220	22"	115097	4L220	22"	115477	4L600	60"
114785	3L230	23"	115105	4L230	23"	115485	4L610	61"
114793	3L240	24"	115113	4L240	24"	115493	4L620	62"
114801	3L250	25"	115121	4L250	25"	115501	4L630	63"
114819	3L260	26"	115139	4L260	26"	115519	4L640	64"
114827	3L270	27"	115147	4L270	27"	115527	4L650	65"
114835	3L280	28"	115154	4L280	28"	115535	4L660	66"
114843	3L290	29"	115162	4L290	29"	115543	4L670	67"
114850	3L300	30"	115170	4L300	30"	115550	4L680	68"
114868	3L310	31"	115188	4L310	31"	115568	4L690	69"
114876	3L320	32"	115196	4L320	32"	115576	4L700	70"
114884	3L330	33"	115204	4L330	33"	115584	4L710	71"
114892	3L340	34"	115212	4L340	34"	115592	4L720	72"
114900	3L350	35"	115220	4L350	35"	115600	4L730	73"
114918	3L360	36"	115238	4L360	36"	115618	4L740	74"
114926	3L370	37"	115246	4L370	37"	115626	4L750	75"
114934	3L380	38"	115253	4L380	38"	115634	4L760	76"
114942	3L390	39"	115261	4L390	39"	117598	4L770	77"
114959	3L400	40"	115279	4L400	40"	115642	4L780	78"
114967	3L410	41"	115287	4L410	41"	115606	4L790	79"
114975	3L420	42"	115295	4L420	42"	115659	4L800	80"
114702	3L430	43"	115303	4L430	43"	117630	4L810	81"
114983	3L440	44"	115311	4L440	44"	115667	4L820	82"
114991	3L450	45"	115329	4L450	45"	118018	4L830	83"
115006	3L460	46"	115337	4L460	46"	115675	4L840	84"
111716	3L480	48"	115345	4L470	47"	115683	4L860	86"
111815	3L500	50"	115352	4L480	48"	118901	4L880	88"
115030	3L560	56"	115360	4L490	49"	115691	4L900	90"
			115378	4L500	50"	115709	4L920	92"
			115386	4L510	51"	115717	4L940	94"
			115394	4L520	52"	116350	4L960	96"
			115402	4L530	53"	116368	4L980	98"
			115410	4L540	54"	115725	4L1000	100"

$2\frac{1}{32}'' \times \frac{3}{8}''$

SKU NO.	MFG NO.	LENGTH	SKU NO.	MFG NO.	LENGTH	SKU NO.	MFG NO.	LENGTH
115733	5L240	24"	115964	5L470	47"	116186	5L690	69"
115741	5L250	25"	115972	5L480	48"	116194	5L700	70"
115758	5L260	26"	115980	5L490	49"	116202	5L710	71"
115766	5L270	27"	115998	5L500	50"	116210	5L720	72"
115774	5L280	28"	116004	5L510	51"	116228	5L730	73"
115782	5L290	29"	116012	5L520	52"	116236	5L740	74"
115790	5L300	30"	116020	5L530	53"	116244	5L750	75"
115808	5L310	31"	116038	5L540	54"	116251	5L760	76"
115816	5L320	32"	116046	5L550	55"	116269	5L780	78"
115824	5L330	33"	116053	5L560	56"	118794	5L790	79"
115832	5L340	34"	116061	5L570	57"	116277	5L800	80"
115840	5L350	35"	116079	5L580	58"	116293	5L820	82"
115857	5L360	36"	116087	5L590	59"	116301	5L840	84"
115865	5L370	37"	116095	5L600	60"	116319	5L860	86"
115873	5L380	38"	116103	5L610	61"	116327	5L880	88"
115899	5L400	40"	116111	5L620	62"	116335	5L900	90"
115907	5L410	41"	116129	5L630	63"	119115	5L920	92"
115915	5L420	42"	116137	5L640	64"	121285	5L960	96"
115923	5L430	43"	116145	5L650	65"	121293	5L980	98"
115931	5L440	44"	116152	5L660	66"	116343	5L1000	100"
115949	5L450	45"	116160	5L670	67"			
115956	5L460	46"	116178	5L680	68"			



**ECONOMY  
 ALUMINUM & VINYL  
 DOOR SWEEP**



available 3' long

Seals door bottom against drafts, dust and insects.

**HEAVY DUTY  
 ALUMINUM & VINYL  
 DOOR SWEEP**

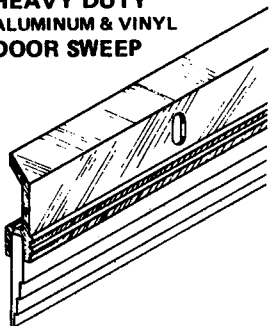

Long lasting door bottom seals against drafts, dust and insects.

**EXTRA HIGH  
 HEAVY DUTY  
 ALUMINUM & VINYL  
 DOOR SWEEP**

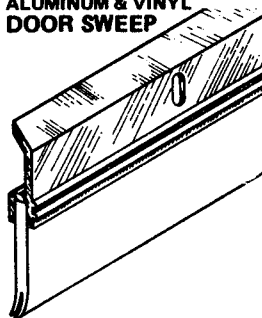

Our best sweep. Extra high to close large gaps. Extra heavy vinyl for long lasting wear.

**RANDALL**

**ALUMINUM & VINYL  
 AUTOMATIC  
 DOOR BOTTOM**

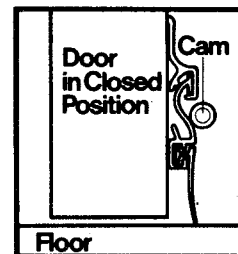

Automatically lowers when door is closed to form weatherproof seal. Raises to clear carpet when door is opened.

SKU NO.	MFG NO.	SIZE	COLOR	SKU NO.	MFG NO.	SIZE	COLOR
807404	V60	3 FT.		807410	V62	3 FT.	
807408	V60	3 FT.	BROWN	807440	V62A	4 FT.	
807407	V60	3 FT.	WHITE	807432	V62	3 FT.	BROWN
				807431	V62	3 FT.	WHITE

SKU NO.	MFG NO.	SIZE	COLOR
807434	V63	3 FT.	
807437	V63A	4 FT.	
807435	V63	3 FT.	BROWN
807436	V63	3 FT.	WHITE

SKU NO.	MFG NO.	SIZE
807401	W65	3 FT.

**GARAGE DOOR  
 BOTTOM  
 WEATHERSTRIP**

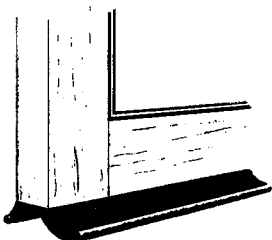

Flexible sponge rubber cushions and weatherseals garage door bottom.

SKU NO.	MFG NO.	SIZE
802503	WSG1-9	9'
802504	WSG1-16	16'

**ALUMINUM & VINYL  
 GARAGE DOOR  
 TOP AND SIDES  
 WEATHERSTRIP**

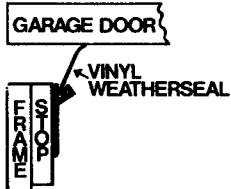

White aluminum with white vinyl seal.

SKU NO.	MFG NO.	SIZE	COLOR
807449	V67	9' x 16'	
807455	V67	9' x 16'	WHITE
807446	V67	9' x 7'	
807452	V67	9' x 7'	WHITE

**REPLACEMENT VINYL**



SKU NO.	MFG NO.	Replacement Vinyl for V-4, V-6, & V-9
807491	RV-4	3' long



SKU NO.	MFG NO.	Replacement Vinyl for V-5
807494	RV-5	3' long

**FELT  
 WEATHERSTRIP**

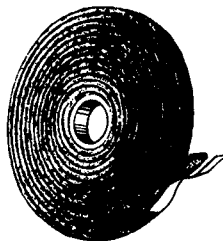

Easy to use economy weatherstrip for windows, doors, refrigerators, etc.

SKU NO.	MFG NO.	LENGTH
802515	WSF58	5/8" x 17'
802516	WSF114	1 1/4" x 17'
802518	WSF200	2" x 17'

**SPONGE RUBBER  
 WEATHERSTRIP**

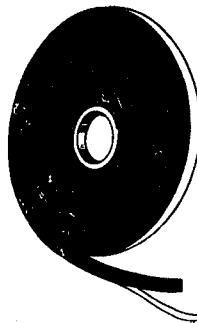

All purpose black sponge with pressure sensitive backing.

SKU NO.	MFG NO.	LENGTH
802519	WSR316	3/16" x 3/8" x 10'
802521	WSR516	5/16" x 3/8" x 10'
802522	WSR516A	5/16" x 3/4" x 10'

**VINYL FOAM WEATHERSTRIP**

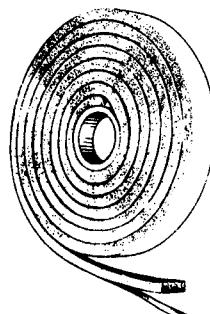

Easy to use closed cell foam with pressure sensitive backing. White color.

SKU NO.	MFG NO.	LENGTH
802509	WSV-14	1/4" x 3/8" x 17'
802507	WSV-12	1/4" x 1/2" x 17'
802510	WSV-34	1/4" x 3/4" x 17'
802512	WSV-200	1/4" x 2" x 17'
802506	WSV-4	5/8" x 17'

**ADHESIVE SPONGE RUBBER**



Sponge rubber weatherstrip has multiple uses around house as well as auto. Adhesive backing on roll permanently bonds to many surfaces. Ideal for larger gaps around doors, windows. In hang-up poly bags.

SKU NO. Number	Size
803967 261	1/8" x 3/8" x 10'
803970 262	1/4" x 3/8" x 10'
803973 263	1/4" x 3/4" x 10'
803976 264	3/8" x 3/8" x 10'
803979 265	3/8" x 3/4" x 10'
803982 266	1/2" x 1/2" x 10'

**GARAGE DOOR SEAL**

**RUBBER BOTTOM**

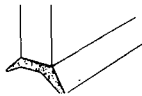

Tough, specially compounded E.P.D.M. extruded rubber. Flexible, conforms to irregularities in garage floors. Resists abrasion and temperature extremes.

No. 910—In 9' length.

SKU NO. 803954

No. 916—In 16' length.

SKU NO. 803957

**PIPE/DUCT INSULATION**

**PIPE WRAP FIBERGLASS**

Do-it-yourself Fiber Glass pipe wrap kit insulates hot or cold water pipes, prevents dripping and sweating. Includes outer plastic wrap. In poly bags.

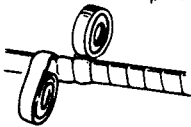

No. 6800—25 ft. of 3" fiberglass and 25 ft. of outer plastic wrap.

SKU NO. 804038

**ALUMINUM & VINYL FOAM PIPE WRAP**



One-piece self-adhesive vinyl foam with protective aluminum foil outer covering wraps around pipes to insulate and prevent heat loss or sweating. Just unroll and wrap. In poly bags.

No. 6803—1/8" thick x 2" wide x 15' long.

SKU NO. 804041

No. 6804—1/8" thick x 2" wide x 30' long.

SKU NO. 804044

**ADHESIVE PILE**



No. 417PL—Cushions sliding windows or doors. Seals out moisture, dirt, draft. Poly bagged, .270" x 17'

SKU NO. 804050

**TRANSPARENT TAPE**



**WATERPROOF TRANSPARENT TAPE**

Self-sealing durable poly tape for weatherstripping and multi-purpose general use. Long lasting.

No. 145—1" x 45' 24 sleeves per case.

SKU NO. 803960

No. 225—2" x 25' 24 sleeves per case.

SKU NO. 803963

**ELECTRIC OUTLET SEAL**

**ELECTRIC OUTLET SEAL**

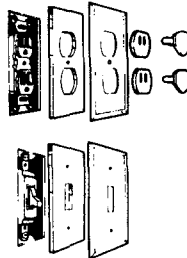

Heat loss and air conditioning leakage are prevented with insulating foam seals. Electric receptacle safety caps are molded plastic and make outlets childproof. Effective draft seals when installed on all wall outlets. UL Listed.

No. 123—3 wall receptacles, 1 light switch, 2 safety caps.

SKU NO. 804029

**WINDOW AIR CONDITIONER SEAL**

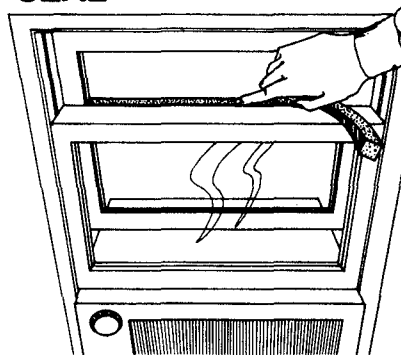

Poly foam wedges between sash and window unit, as well as sash and glass for better weather seal. Keeps out bugs, too.

No. 19—1/4" x 1 1/4" x 42" in hang-up poly bag.

SKU NO. 804026

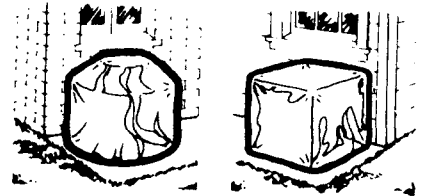

**STANDARD AIR CONDITIONER COVER**

**WINDOW UNIT COVER**

No. 17—Heavy gauge vinyl fits all standard 5,000-10,000 BTU window units. Keeps out draft and dust. 27"W x 18"H x 18"D. Straps and fasteners included.

SKU NO. 804023

No. 15—Square style fits all square central air conditioners up to 34" wide x 30" high x 34" deep. Packed one per hang-up poly bag.

SKU NO. 804020

**Door Weatherstrip Sets**

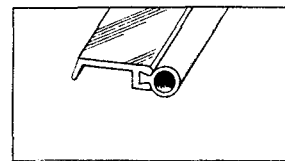

SKU NO.	MFG. NO.	COLOR
807428	V-73	Mill Finish
807443	V-73-WH	White
807482	V-73-BR	Brown

**Air Conditioner Weatherstrip**

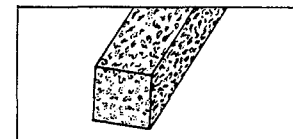

SKU NO.	MFG. NO.	SIZE
802513	WSA-42	1 1/4" x 1 1/4" x 42 Long

4

**DOOR SET**

**No. V-5 BRONZE**

4 pcs. 7/8" x 42"  
1 pc. 7/8" x 36"  
1 pc. 6" lock strip with nails

SKU NO. 803927



**QUALITY EXTRUDED ALUMINUM & VINYL**

For either wood or metal door jamb installations.

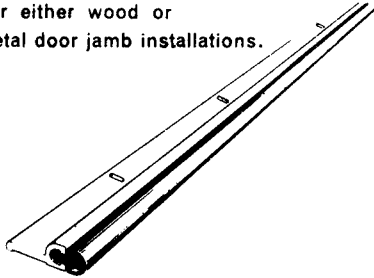

**No. 79V**—2 pcs., 7' long; 1 pc. 3' long; with sheet metal screws; in poly pack.

SKU NO. 803930

**WOOD & VINYL FOAM**

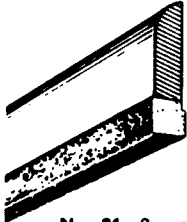

Closed cell vinyl foam specially bonded to select wood moulding. Unaffected by weather.

**No. 81**—2 pcs. 7' long; 1 pc. 3' long; nails, each set sleeved.

SKU NO. 803933

**HEMMED METAL DOOR KIT**

Enough stripping for both sides and the top of 3' x 7' door. Installs without removing doors. Also suitable for windows.

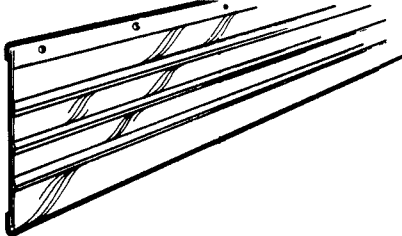

**No. 4018**—Economical spring bronze with brass plated nails. Size 1 1/8" x 17'.

SKU NO. 803936

**ALL VINYL STORM DOOR SWEEP**

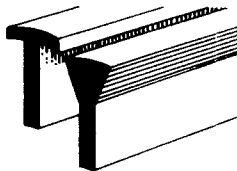

**No. 37V**—Extruded vinyl replaces worn sweep on aluminum storm door bottom. V-profile, 37" in poly bag.

SKU NO. 803948

**No. 37T**—Same as above. T-profile.

SKU NO. 803945

**ALUMINUM & VINYL**

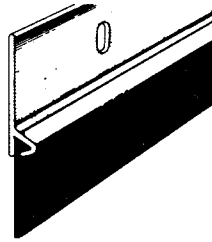

**No. A54P**—Durable extruded aluminum slotted for screws. Has soft, flexible vinyl lip sweep action. In 36 3/4" length, complete with screws.

SKU NO. 803942

**INNER-SEAL WEATHERSTRIP**

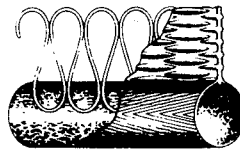

Spring steel wire molded in live sponge rubber patented construction. Waterproof Neoprene coating.

**No. BIS-17**—17' Beige coil in poly bag.

SKU NO. 803939

**V-SHAPED POLYPROPYLENE FIN**

**SELF-ADHESIVE POLYPROPYLENE**

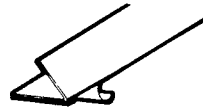

Easy to install adhesive roll of polypropylene weatherstrip for doors and windows.

**No. 7VW**—17 ft. roll, white, in hang-up box. Wt. 2-1/2 lbs.

SKU NO. 804032

**No. 7VB**—17 ft. roll, brown, in hang-up box. Wt. 2-1/2 lbs.

SKU NO. 804035

**FLIP SEAL™**

**AUTOMATIC ALUMINUM & VINYL**

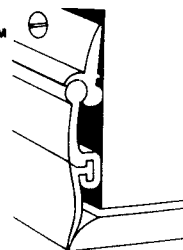

**No. FS36AG**—Durable, flexible vinyl strip locked in sturdy aluminum frame, 36" length. Automatically flips up to clear carpeting and threshold as door is opened. For all inswinging doors. Easily installed without removing door.

SKU NO. 803951



**FELT**

**STORM QUEEN®**

Made of 3/8" thick, extra quality felt. Packed in hang-up poly bags.

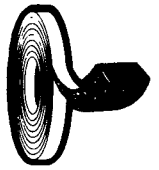

SKU NO.	Number	Size
804053	6504	2" x 17'

**SELF-ADHESIVE FOAM & RUBBER**

**PVC CLOSED CELL VINYL FOAM TAPE**

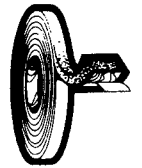

Airtight self-adhesive vinyl foam. Hundreds of household and automotive uses.

SKU NO.	Gray Color Number	Size
803999	201	1/8" x 1/4" x 17'
804002	202	3/16" x 3/8" x 17'
804005	203	1/4" x 3/8" x 17'
804008	204	3/8" x 1/2" x 10'
804011	205	3/8" x 3/4" x 10'
804014	206	3/16" x 3/8" x 30'

**CAMPERMOUNT**

**No. 304**—PVC closed cell vinyl foam tape acts as cushion and seal between truck and camper unit. 3/4" thick x 1 1/4" wide x 30' long.

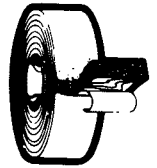

SKU NO. 804017

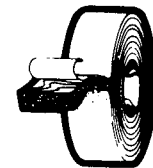

**DRAFT SEAL™ OPEN CELL FOAM**

Cushioning poly foam sponge with pressure sensitive adhesive backing. Hundreds of household and automotive uses.

SKU NO.	Charcoal Color Number	Size
803984	18-1	3/16" x 3/8" x 17'
803987	18-2	3/16" x 3/4" x 17'
803990	18-3	1/2" x 3/4" x 17'
803993	18-4	3/8" x 1/2" x 17'
803996	18-5	3/16" x 3/8" x 30'

4

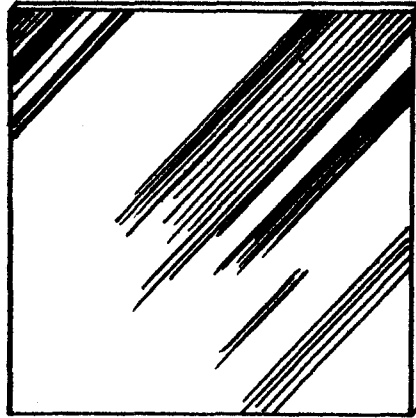

**PLEXIGLASS - METHACRYLATE Fed Spec #LP3910**

Acrylic sheets are optically clear for standard home or office use as well as industrial application. Acrylic sheets offer good impact and weather resistance. All thickness sheet can be custom cut to sizes needed.

SKU	SIZE	SKU	SIZE
18 PLEX	1/8" x 48" x 96"	18 PLEX F	Cut to size
316 PLEX	3/16" x 48" x 96"	316 PLEX F	Cut to size
14 PLEX	1/4" x 48" x 96"	14 PLEX F	Cut to size

**4**

Highest quality float glass graded according to the highest standards in the industry. Superb clarity and cutting ease. We will custom cut to your size needs.

**SINGLE STRENGTH B WINDOW GLASS**

SIZE	12"	16"	20"	24"	26"	28"	30"	32"	34"	36"	38"	42"	44"	46"
10"	217869													
12"		217893		221796						221911				
14"			222034											
16"			217679	217687			222273			222281				
18"								222463						
20"							222497			222612				
24"				217703	217711					217745				
26"						217752								
28"									223396		223412			
30"										217810				
32"									223438					
34"														214361
36"													223453	
38"												214387		

**DOUBLE STRENGTH B WINDOW GLASS**

24"						238535			238543					
30"									238600					

Wire Glass Size	SKU NO.
11" x 11" x 1/4"	300125
25" x 31" x 1/4"	300160
6" x 21" x 1/4"	300145



# 3M Indoor Window and Patio Door Insulator Kits



SKU NO.	MFG. NO.	SIZE
510635	50023	42" x 62"
510640	50024	62" x 210"



SKU NO.	MFG. NO.	SIZE
510665	50125	84" x 112"



SKU NO.	MFG. NO.	SIZE
510645	01686	17"
510650	01687	17"

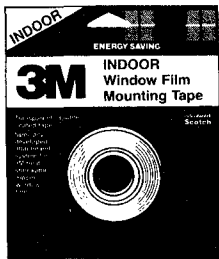

SKU NO.	MFG. NO.	SIZE
510670	50126	500'



SKU NO.	MFG. NO.	SIZE
510675	56266	5/16" x 17"



SKU NO.	MFG. NO.	SIZE
803500	53082	42" x 62"
803505	53083	62" x 210"
803515	53223	84" x 112"

### WINDOW MOUNT TAPE

SKU NO.	MFG. NO.	SIZE
803520	53224	500'

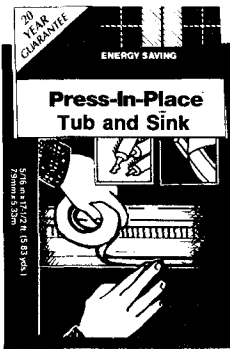

SKU NO.	MFG. NO.	SIZE
501679	53335	5/16" x 17"

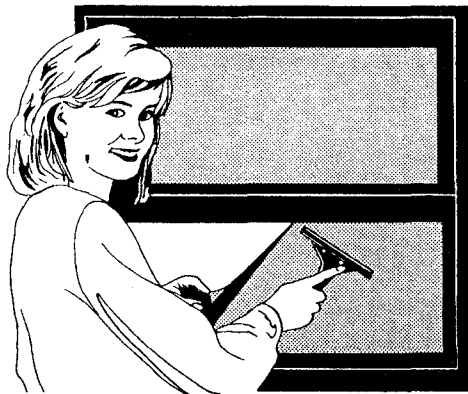

### WINDOW TINTING

Solar stat is a flexible vinyl window tinting, that adheres through the use of static electricity without glue or adhesives, is removable, simply lift a corner and lift off and can be used again.

SKU NO.	MFG. NO.	SIZE	COLOR
459015	SSB24-15	24" x 15'	BRONZE
459025	SSB36-15	36" x 15'	BRONZE
459035	SSB48-15	48" x 15'	BRONZE
459020	SSB24-15	24" x 15'	GREY
459030	SSB36-15	36" x 15'	GREY
459040	SSB48-15	48" x 15'	GREY

PLACE YOUR ORDERS BY FAX ON OUR ORDER FORM TO RECEIVE YOUR SPECIAL 2% DISCOUNT.

WE ARE PLEASED TO SPECIAL ORDER ITEMS THAT ARE NOT ALREADY IN OUR INVENTORY

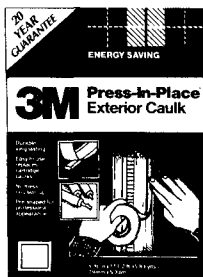

SKU NO.	MFG. NO.	SIZE
510677	53377	7/16" x 15'





**GUTTERS 5"K  
 ALUMINUM OR GALVANIZED**

SKU NO.	MFG. NO.	LENGTH	TYPE
102655	562	10' STD	WHITE
102760	521	10' 28GA	GALVANIZED

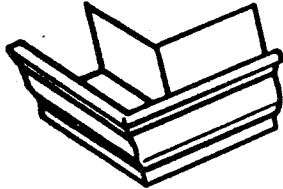

**MITRE OUTSIDE 5"K  
 ALUMINUM OR GALVANIZED**

SKU NO.	MFG. NO.	TYPE
102665	5527	WHITE
102765	2633	GALVANIZED

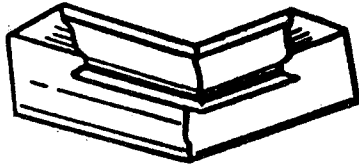

**MITRE INSIDE 5"K  
 ALUMINUM OR GALVANIZED**

SKU NO.	MFG. NO.	TYPE
102670	5528	WHITE
102770	2634	GALVANIZED

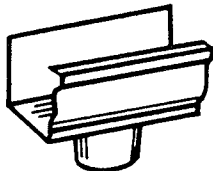

**END PIECE W/DROP 5"**

SKU NO.	MFG. NO.	TYPE
102685	5537	WHITE
102800	2540	GALVANIZED

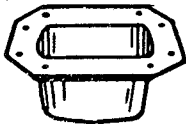

**RIVET TUBE 5"**

SKU NO.	MFG. NO.	TYPE
102735	5568	WHITE
102790	2670	4" GALVANIZED
102785	2669	3" SQ. GALV.



**CLINCHER BAND**

SKU NO.	MFG. NO.	TYPE
102865	3192	3" GALVANIZED

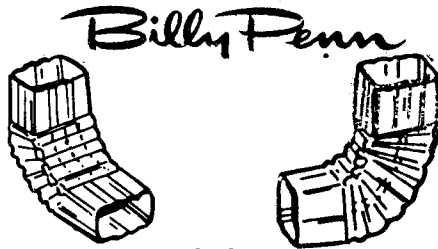

**ELBOWS 5"K**

SKU NO.	MFG. NO.	SIZE	STYLE	TYPE
102715	5465	3"	A STD	WHITE
102720	5466	3"	B STD	WHITE
102757	5448	4"	A	WHITE
102758	5449	4"	B	WHITE
102845	5046	3"	A	GALV.
102850	5054	3"	B	GALV.
102855	5150	4"	A	GALV.
102860	5158	4"	B	GALV.
102905		4" x 5"	A	GALV.
102906		4" x 5"	B	GALV.



**END CAPS 5"K**

SKU NO.	MFG. NO.	TYPE
102700	5553-R	WHITE
102695	5554-L	WHITE
102775	2653-R	GALVANIZED
102780	2654-L	GALVANIZED



**SLIP JOINT 5"K**

SKU NO.	MFG. NO.	TYPE
102690	5597	WHITE
102795	2666	GALVANIZED

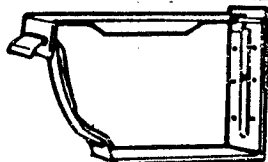

**CROSSBAR HANGER 5"K**

SKU NO.	MFG. NO.	TYPE
102710	5595	WHITE
102810	1110	GALVANIZED

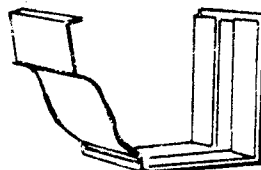

**RIVET MITRE 5"K WHITE**

SKU NO.	MFG. NO.	TYPE
102675	5535-OUTSIDE	ALUMINUM
102680	5536-INSIDE	ALUMINUM

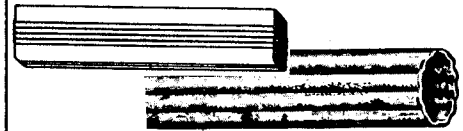

**ROUND DOWNSPOUTS  
 ALUMINUM OR GALVANIZED**

SKU NO.	MFG. NO.	SIZE	STYLE	TYPE
102825	506	3" x 10'	28	GALV.
102835	407	4" x 10'	26	GALV.
102890		5"		GALV.
102895		6"		GALV.

**SQUARE DOWNSPOUTS**

SKU NO.	MFG. NO.	SIZE	STYLE	TYPE
102660	578	10' x 2" x 3"	26	ALUM.-WHITE
102830	511	10' x 2" x 3"	28	GALV.
102840	612	10' x 3" x 4"	26	GALV.
102756	586	10' x 3" x 4"	28	ALUM.-WHITE
102817	562	3" x 30"		EXT. GALV.
102662		10' x 4" x 5"		GALV.
102661		10' x 4" x 5"		ALUM.-WHITE

**BRICK HOOKS (Square)**



103043	4" x 5"
--------	---------

**SQUARE OUTLET**

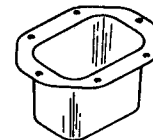

SKU NO.	SIZE
103046	4" x 5"



**UNIVERSAL BAND 5" K**

SKU NO.	MFG. NO.	TYPE
102816	1155	GALVANIZED
102725	5593	3" WHITE



**CORRUGATED  
 ROUND ELBOWS**

SKU NO.	MFG. NO.	SIZE	TYPE
102851	5026	3"	28 GA.
102861	5130	4"	28 GA.
102910		5"	28 GA G
102915		6"	28 GA G

**4**

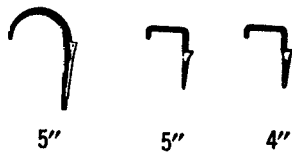

**BRICK & WOOD HOOKS**

SKU NO.	MFG. NO.	TYPE
102755	5578	GALVANIZED
102750	5579	WOOD-ALUMINUM
102878	3108	BRICK
102870	3101	ROUND GALVANIZED
102875	3107	MASON GALVANIZED
102873	3102	4" ROUND MASON



**HIDDEN HANGER  
5"K**

SKU NO.	MFG. NO.	TYPE
102730	1725	BAG/5



**STRAP HANGER**

SKU NO.	MFG. NO.	TYPE
102705	5571	WHITE
102876	1154	GALVANIZED



**MESH STRAINER**

SKU NO.	MFG. NO.	TYPE
102877	6704	3"

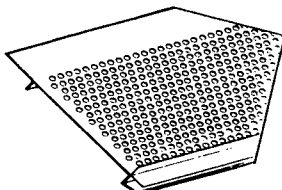

**GUTTER SCREEN**

SKU NO.	MFG. NO.	TYPE
102916	1750	6" x 20'

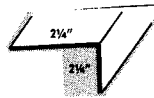

**GUTTER APRON  
ROOF EDGE**

SKU NO.	MFG. NO.	TYPE
102945	259	GALVANIZED

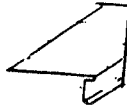

**OVERHANG ROOF EDGE**

SKU NO.	MFG. NO.	STYLE
102930	280	D-4 1/2" GALVANIZED

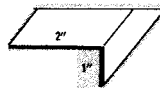

**ROOF FLASHING TRIM**

SKU NO.	MFG. NO.	TYPE
102920	223	STYLE XA-2" GALV.

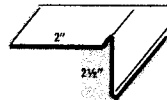

**GRAVEL STOP**

SKU NO.	MFG. NO.	TYPE
102935	256	10' x 5 1/2" GALV.



**STEP FLASHING**

SKU NO.	MFG. NO.	TYPE	SIZE
103035	6727	ALUMINUM	5" x 7"
102950	6530	GALVANIZED	5" x 7"

**GALVANIZED SHEET  
METAL**

SKU NO.	SHEET SIZE	GAUGE
651489	3' x 3'	30
651488	3' x 8'	28

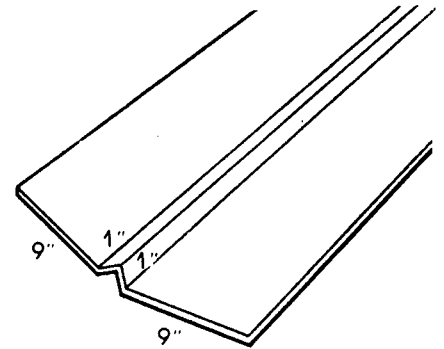

**PRE-FORMED W/ VALLEY-8'**

SKU NO.	MFG. NO.	TYPE
102940	300	GALVANIZED

**VALLEY ROLL  
ALUMINUM FLASHING**

.019" Thick  
Sold by the foot or by roll.

SKU NO.	PART NO.	WIDTH	ROLL LENGTH
102960	89201	6"	50 ft.
102975	89268	10"	50 ft.
102980	89284	12"	50 ft.
102995	89300	14"	50 ft.
103010	89326	20"	50 ft.
103015	836361	28"	50 ft.

**VALLEY ROLL  
ALUMINUM FLASHING**

.019" Thick  
Sold by the roll only.

SKU NO.	PART NO.	WIDTH	ROLL LENGTH
102970	89060	10"	10'
102985	89086	14"	10'
102990	89144	14"	25'
103005	89169	20"	25'
103020	89367 (white)	10"	10'

**STC STEEL CITY RURAL MAILBOXES and MOUNTING POSTS**

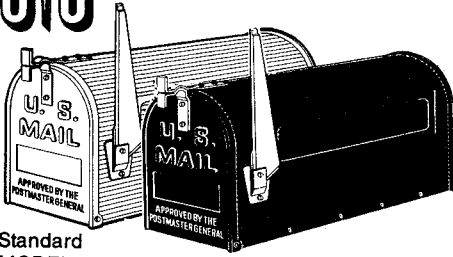

Standard  
MODEL 1-1

Mailbox size is 18¾", 8¾" high,  
6¼" wide.

SKU NO.	MFG. NO.	COLOR
804521	1-C	White
804524	1-C	Black
804518	1-1	Aluminum

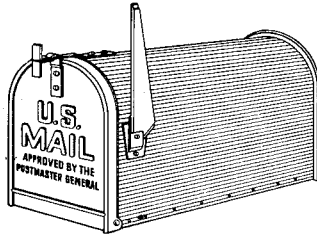

**MEDIUM  
MODEL 1-1½**

Available in black or  
painted aluminum.  
21" long, 11" high,  
8¼" wide.

SKU NO.	MFG. NO.	COLOR
804530	1-1½B	Black
804527	1-1½	Alumin

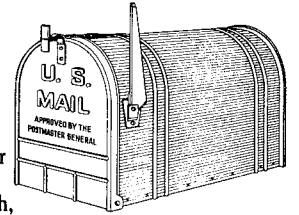

**LARGE  
MODEL 2-2**

Available in black or  
painted aluminum.  
23½" long, 15" high,  
11¼" wide.

SKU NO.	MFG. NO.	COLOR
804536	2-2B	Black

**MAIL/MAGAZINE SLOT**

**No. 620**  
Opening: 2" x 11"

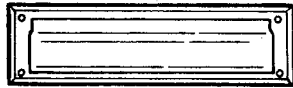

Spring Loaded Front Plate

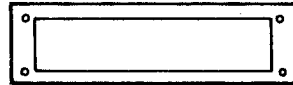

Standard Back Plate

SKU NO.	MFG. NO.	COLOR
804506	C620B3	Bright Brass
804509	C620PA28	Aluminum Satin Finish

**MAIL/LETTER SLOT**

**No. 626**  
Opening: 1½" x 7"

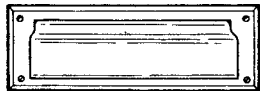

Spring Loaded Front Plate

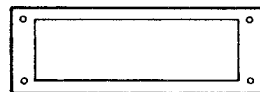

Standard Back Plate

SKU NO.	MFG. NO.	COLOR
804512	C626B3	Bright Brass
804515	C626PA28	Aluminum Satin Finish

**STEEL POSTS**

MODEL EP-1

Econo Post

Fits only Model no. 1 mailbox

SKU NO. 808121

MODEL 15-1

Post -L- Post

5-FT.

SKU NO. 808115

MODEL CS-1

Country Squire 5-FT.

Wrought Iron

SKU NO. 808118

**4**

**STOP SAGGING FLOORS WITH A TEL-O-POSTS**

**Help Stop:**

- Sagging Floors
- Wall Cracks
- Sticking Doors & Windows

**SHORTY TEL-O-POSTS SPECIAL**

- Mobile Homes
- Decks
- Crawl Spaces
- Porches
- Adjustable

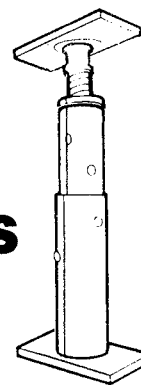









SKU NO.	MFG. NO.	HEIGHT
800429	79C	4'-6"-7'-9" Champ









SKU NO.	MFG. NO.	HEIGHT
800438	2T	3'-1"-5'-0"
800441	3T	1'-8"-3'-0"
800444	4T	12"-15"

**NYLON HOLE PLUGS**

3/16" up to 1".





#89062 (DP-187)  Pkg/30 FOR 3/16" HOLE BLACK	#89076 (DP-250)  Pkg/30 FOR 1/4" HOLE BLACK	#89077  Pkg/30 FOR 1/4" HOLE WHITE	#89078 (DP-312)  Pkg/30 FOR 5/16" HOLE BLACK	#89079 (DP-375)  Pkg/30 FOR 3/8" HOLE BLACK	#89080  Pkg/30 FOR 3/8" HOLE WHITE	#89082 (DP-437)  Pkg/25 FOR 7/16" HOLE BLACK	#89084 (DP-500)  Pkg/25 FOR 1/2" HOLE BLACK
--	---	---	--	---	---	--	---

SKU NOS. 809270 809273 809276 809279 809282 809285 809288 809294





#89085  Pkg/25 FOR 1/2" HOLE WHITE	#89086 (DP-562)  Pkg/15 FOR 9/16" HOLE BLACK	#89087 (DP-625)  Pkg/15 FOR 5/8" HOLE BLACK	#89088  Pkg/15 FOR 5/8" HOLE WHITE	#89089 (DP-687)  Pkg/10 FOR 11/16" HOLE BLACK	#89091 (DP-750)  Pkg/10 FOR 3/4" HOLE BLACK	#89092  Pkg/10 FOR 3/4" HOLE WHITE	#89097 (DP-875)  Pkg/8 FOR 7/8" HOLE BLACK	#89098  Pkg/14 FOR 1" HOLE WHITE
---	--	---	---	---	---	---	--	---

SKU NOS. 809300 809306 809309 809312 809315 809318 809321 809324 809327

**STORMDOOR AND WINDOW CLIP**

#88698 DOOR INSERT CLIP Pkg/25 	#88667 WHITE DOOR PANEL CLIP Pkg/25 	#88665 MILL DOOR PANEL CLIP Pkg/25 	#88675 NYLON FLUSH SCREEN CLIP Pkg/25 
--	---	--	---

SKU NOS. 803477 808190 808193 802238

#88734 MILL CLIP Pkg/25 	#88728 MILL CLIP Pkg/25 	#88736 WHITE CLIP Pkg/25 	#88730 WHITE CLIP Pkg/25 
--	--	---	---

SKU NOS. 808307 808367 808319 808469

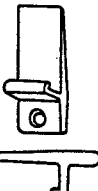
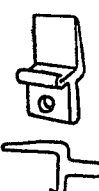



#89632 CLIPS (Actual size) Pkg/25 	#89634 CLIPS (Actual size) Pkg/25 
Screw and cap comes with clip.	Screw and cap comes with clip.
#25 SCREWS Pkg/25	#25 SCREWS Pkg/25

SKU NO. 601122 SKU NO. 601131

**ALUMINUM SCREW POST SEX SCREW**



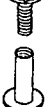

#88732  
NYLON THUMB  
CLIP  
Pkg/25  

SKU NOS. 808199

#89470 Pkg/12  1/2" EXTENSION	#89472 Pkg/12  1" EXTENSION	#89447 Pkg/12  3/16" POST	#89449 Pkg/12  1/4" POST *	#89451 Pkg/12  3/8" POST	#89453 Pkg/12  1/2" POST
---	---	--	--	--	--

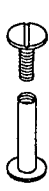
SKU NOS. 850096 850099 850102 850108 850111 850114

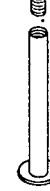
contains ten sizes of screw posts and two sizes of extensions. The extensions are used to make screws longer. The screws are used to bind plastic, leather, paper and photo albums. Also acts as a good substitute for rivets. Made of aluminum #8/32 machine screw. (5/32 Stove Bolt).

#89455 Pkg/12  5/8" POST	#89458 Pkg/20  3/4" POST	#89460 Pkg/20  1" POST	#89462 Pkg/20  1 1/4" POST	#89464 Pkg/20  1 1/2" POST	#89468 Pkg/20  2" POST
--	--	---	--	--	--

SKU NOS. 850117 850123 850126 850129 850132 850138

**DOWEL AND PLUGS**

<b>SKU NOS.</b> 809383	#93299 SCREW HOLE BUTTON 1/2" REFILL/125
809390	#93301 SCREW HOLE BUTTON 3/8" REFILL/125
809378	#92795 FLAT BUTTON 1/4" REFILL/125
809387	#91326 FLAT BUTTON 1/2" REFILL/125
809381	#91329 FLAT BUTTON 5/16" REFILL/125
809384	#91328 FLAT BUTTON 3/8" REFILL/125
809402	#91123 DOWEL 3/8" x 1 1/2" REFILL/50
809396	#D14114 DOWEL 1/2" x 1 1/4" REFILL/50
809405	#91110 DOWEL 1/2" x 1 1/2" REFILL/32
809399	#91126 DOWEL 5/16" x 1 1/2" REFILL/50

<b>SKU NOS.</b>	ROUND BUTTON Pkg/125
805378	3/8" #FRB38
809375	1/2" #92793

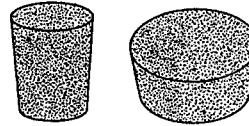

contains 17 sizes of corks from 1/4" dia. to 1-1/2" dia.

SKU NO.	PART NUMBER	DESCRIPTION TOP DIAMETER	BOTTOM DIAMETER	LENGTH	PACKS
809856	#93816	Size: 1/4" dia.	5/32" dia.	1/2"	Pk 50
809863	#93815	Size: 5/16" dia.	5/16" dia.	1/2"	Pk 50
809867	#93814	Size: 3/8" dia.	9/32" dia.	1/2"	Pk 50
809873	#93821	Size: 7/16" dia.	21/64" dia.	5/8"	Pk 50
809876	#93836	Size: 1/2" dia.	3/8" dia.	11/16"	Pk 50
809879	#93842	Size: 9/16" dia.	27/64" dia.	3/4"	Pk 40
809882	#93844	Size: 5/8" dia.	15/32" dia.	13/16"	Pk 30
809885	#93846	Size: 11/16" dia.	17/32" dia.	7/8"	Pk 20
809888	#93848	Size: 3/4" dia.	37/64" dia.	15/16"	Pk 20
809891	#93850	Size: 13/16" dia.	5/8" dia.	1"	Pk 20
809894	#93852	Size: 7/8" dia.	43/64" dia.	1-1/16"	Pk 15
809897	#93854	Size: 15/16" dia.	47/64" dia.	1-1/4"	Pk 10
809901	#93822	Size: 1" dia.	49/64" dia.	1-1/4"	Pk 20
809904	#93824	Size: 1-1/8" dia.	57/64" dia.	1-1/4"	Pk 15
809907	#93825	Size: 1-1/4" dia.	1-1/64" dia.	1-1/4"	Pk 15
809910	#93827	Size: 1-3/8" dia.	1-3/32" dia.	1-1/2"	Pk 20
809913	#93829	Size: 1-1/2" dia.	1-9/32" dia.	1-1/2"	Pk 20



**RUBBER WASHERS**

6 sizes of rubber washers from #6 screw size to 7/16" I.D.

SKU NO. 601101	SKU NO. 601104	SKU NO. 601107
 #90326 Pkg/100 Fits #6 and #8 screw	 #88209 Pkg/100 Fits #10 screw	 #88593 Pkg/100 Fits 1/4" screw
 #89335 Pkg/100 3/4" O.D. X 5/16" I.D. NEOPRENE RUBBER WASHER	 #90215 Pkg/100 7/8" O.D. X 3/8" I.D. NEOPRENE RUBBER WASHER	 #88095 Pkg/100 1" O.D. X 7/16" I.D. NEOPRENE RUBBER WASHER

**SNAP FASTNERS**

 #93811 SOCKET Pkg/50	 #90883 EYELET Pkg/50	 #90882 STUD Pkg/50	 #93810 BUTTON Pkg/50	 #93812 STUD WITH SCREW Pkg/40
<b>SKU NO.</b> 850141	<b>SKU NO.</b> 850144	<b>SKU NO.</b> 850147	<b>SKU NO.</b> 850153	<b>SKU NO.</b> 850156

**SEX SCREW**

Used where threads are not practical such as door closers on hollow metal doors.

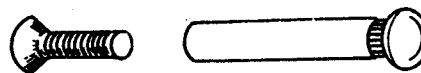

Size 10/24 x 1-3/4"  
Aluminum  
All Pkg./5

**SKU NO. 852578**

#263

**SKU NO.**  
601113      **SKU NO.**  
601116      **SKU NO.**  
601119

**Our catalog does not contain everything in our inventory. If there are products you do not find that are related to those in this catalog call 437-1288 so that we may assist you.**

**4**

**RUBBER CORD PROTECTORS**

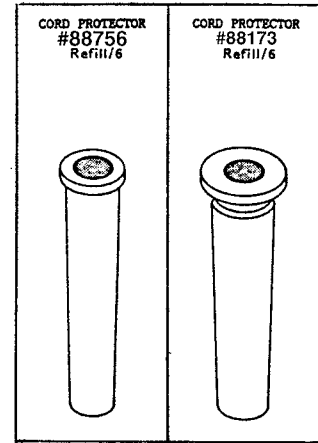

CORD PROTECTOR  
#88756  
Refill/6

CORD PROTECTOR  
#88173  
Refill/6

SKU NO.  
555121

SKU NO.  
555119

**BALL BEARINGS**

Assortment of 6 sizes of ball bearings.

#89861 Pkg/100 5/32"	#89509 Pkg/27 3/8"	#90130 Pkg/15 7/16"
●	●	●
SKU NO. 808949	SKU NO. 809054	SKU NO. 809228
#89200 Pkg/75 3/16"	●	●
●		

SKU NO. 809222

**REDUCERS**

Pkg. 16					
REDUCER #88024 1/2" O.D. 3/8" I.D. 1 1/2" LONG	REDUCER #88024 1/2" O.D. 3/8" I.D. 1 1/2" LONG	REDUCER #88025 Pkg. 16 1/2" O.D. 7/16" I.D. 1 1/2" LONG	REDUCER #88026 Pkg. 5 5/8" O.D. 1/2" I.D. 3 1/4" LONG	#89830 Pkg/48 5/16"	#88587 Pkg/50 1/4"
				●	●
				SKU NO. 809225	SKU NO. 808970

SKU NOS. 809243

809246

809249

**SHOULDER BOLTS**

6 lengths of shoulder bolts, and nuts for lawn mower wheels. These items are COLOR CODED to help you

#93226 SHOULDER BOLT Pkg/ 8	#93224 SHOULDER BOLT Pkg/ 8	#93220 SHOULDER BOLT Pkg/ 8	#93228 SHOULDER BOLT Pkg/ 8	#93222 SHOULDER BOLT Pkg/ 8	#93230 SHOULDER BOLT Pkg/ 8
15/16"	GREEN 1-3/8"	RED 1-1/2"	BROWN 1-5/8"	BLUE 1-3/4"	2"
5/8"	5/8"	5/8"	5/8"	5/8"	5/8"

SKU NOS. 808517

808592

808595

808658

808940

808946