

Power Tools

Categories	Pages
CIRCULAR SAW BLADES	224, 243-245
DREMEL TOOLS & ACCESSORIES	238-241
DRILL BITS & SETS	254-266
DRILL CHUCKS & ACCESSORIES	252-253
ELECTRIC BENCH GRINDERS	231
GRINDING & WIRE WHEELS	246-247
HOLE CUTTERS & WOOD BORES	266
HOLE SAWS	266
POWER DRIVER BITS	248-251
POWER NAILERS	214, 231
POWER TOOL ACCESSORIES	217-218, 224
RECIPROCATING SAW BLADES	237
ROUTER BITS	225-230
TOOLS, POWER	212-216, 219-223, 231-235
WELDING ROD & ACCESSORIES	267-272





High Performance Industrial Tools

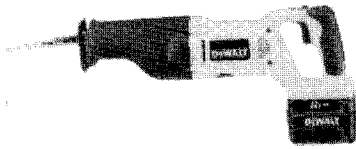

**HEAVY-DUTY 24V
 RECIPROCATING SAW KIT**

- Lever action keyless blade clamp
- Electric brake for greater control
- 3-Position adjustable shoe
- Two-speed control for metal and wood cutting
- Convenient on-board blade storage

MFG. NO. DW008K SKU NO. 72DW008K

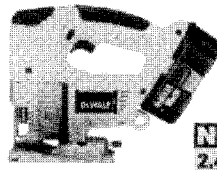

**NEW
 2.4 Ah
 BATTERY**

**HEAVY-DUTY 18V
 VARIABLE SPEED
 JIG SAW KIT**

- 3-position orbital action
- Accepts universal and T-shank blades
- Tool free adjustable shoe slides forward, backward and bevels 45° in both directions

MFG. NO. DW933K SKU NO. 72DW933K



**NEW
 2.4 Ah
 BATTERY**

**HEAVY-DUTY 18V
 5-3/8" (136mm)
 CORDLESS
 TRIM SAW KIT**

- Cuts 2X materials in a single pass
- Left side blade provides maximum visibility
- Replaceable brushes for longer motor life
- DeWALT-built high-performance motor with fan cooling delivers maximum power and durability

MFG. NO. DW936K SKU NO. 72DW936K

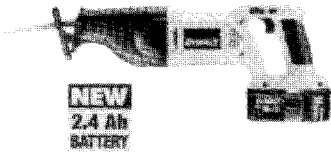

**NEW
 2.4 Ah
 BATTERY**

**HEAVY-DUTY 18V
 RECIPROCATING SAW KIT**

- Keyless blade clamp for quick blade change
- Compact and lightweight; 6.5 lbs.
- Pivoting shoe with open top for maximum visibility
- Variable speed trigger for blade control

MFG. NO. DW938K SKU NO. 72DW938K

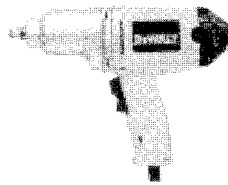

**HEAVY-DUTY 3/4"
 (13mm) IMPACT WRENCH**

- AC/DC forward/reverse rocker switch
- Delivers full power of torque in forward and reverse
- Ball-bearing construction

MFG. NO. DW296 SKU NO. 72DW296

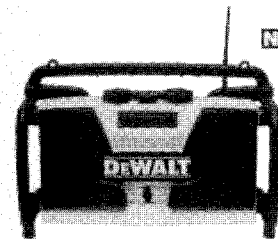

NEW

**HEAVY-DUTY WORK SITE
 RADIO/CHARGER**

- Powered by 9.6V-18V DeWALT NiCd batteries
- AM/FM radio with auxiliary port
- High impact roll cage
- Flexible antenna
- Battery sold separately
- Steel speaker grills
- Weather resistant

MFG. NO. DW911 SKU NO. 671032

DEWALT®

High Performance Industrial Tools

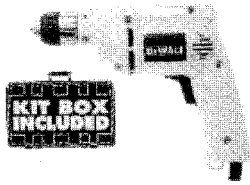

HEAVY-DUTY 3/8" (10mm) VSR DRILL

- All ball-bearing construction provides greater durability
- Contoured textured handle for better grip
- Built-in two-way level for drilling accurate vertical and horizontal holes
- Heavy-duty Jacobs® keyless chuck provides greater bit retention

MFG. NO.	SKU NO.
DW106	72DW106

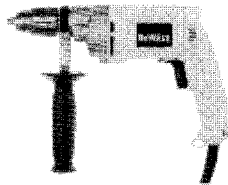

HEAVY-DUTY 1/2" (13mm) VSR DRILL

- Helical-cut steel, heat-treated gears for increased durability and long gear life
- Metal gear housing for increased durability
- Two-finger, rubber trigger for increased comfort
- 360° side handle for greater control

MFG. NO.	SKU NO.
DW235G	72DW235G



HEAVY-DUTY 12V 3/8" (10mm) RIGHT ANGLE DRILL/DRIVER KIT

- Multi-grip rubber trigger for comfortable use in tight areas
- Variable speed, reversing
- Durable, right-angle transmission with sealed ball bearings and cut-steel gears

MFG. NO.	SKU NO.
DW965K	72DW965K

3



HEAVY-DUTY 18V 1/2" (13mm) ADJUSTABLE CLUTCH DRILL/ DRIVER KIT

- DeWALT-built high-performance motor with fan cooling delivers maximum power and durability
- 5 steel-planet transmission and copper-plated switch provide job site durability
- Includes charger, batteries, screwdriver bit, kit box

MFG. NO.	SKU NO.
DW995K-2	72DW995K-2

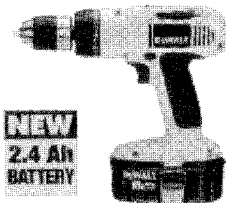

HEAVY-DUTY 18V 1/2" (13mm) ADJUSTABLE CLUTCH DRILL/ DRIVER KIT

- DeWALT-built high-performance motor with fan cooling delivers maximum power and durability
- 5 steel-planet transmission and copper-plated switch provide job site durability
- Includes charger, batteries, screwdriver bit, kit box

MFG. NO.	SKU NO.
DW995KC-27	2DW995KC-2

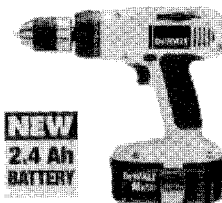

HEAVY-DUTY 18V 1/2" (13mm) ADJUSTABLE CLUTCH HAMMERDRILL/ DRILL/DRIVER KIT

- DeWALT-built high-performance motor with fan cooling delivers maximum power and durability
- 5 steel-planet transmission and copper-plated switch provide job site durability
- Includes charger, batteries, screwdriver bit, kit box

MFG. NO.	SKU NO.
DW997K	72DW997K

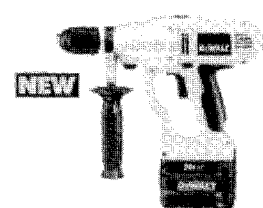

HEAVY-DUTY 24V 1/2" (13mm) DRILL/ HAMMERDRILL KIT

- Combines drill and hammerdrill into one tool
- All metal chuck with carbide tipped jaws prevents bit slippage in high-torque and hammer-drilling applications
- 360° side handle

MFG. NO.	SKU NO.
DW006K	72DW006K



Pneumatic Framing Strip Nailer

- Unmatched Power-to-Weight Ratio
- The Lightest 3-1/2" Nailer
 - Ergonomic Design
- Adjustable Work Contacting Element
 - Durable and Reliable

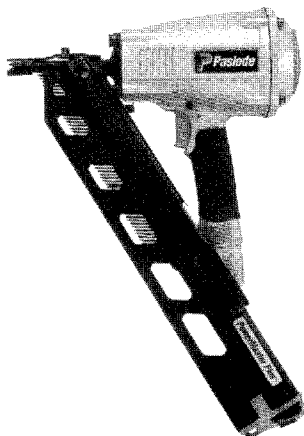

- **Well Balanced** - Center of gravity is closer to trigger, providing better balance
- **Allen Wrench** included to quickly adjust work contacting element and diffuser cap
- **Recessed Release Latch** - Release on follower is comfortable to use
- **Angled Air Inlet** - Keeps hose out of the way when loading nails

SKU No.	Mfg. No.
F350S	72F350S

Cordless Finish Nailer
The Only Cordless Finish Nailing System for the Professional!

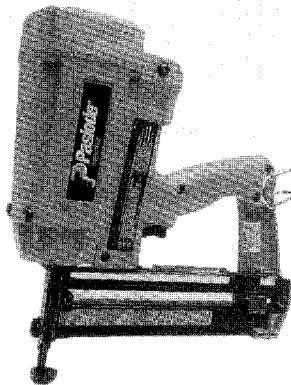

- **Fast Set-Up** - No hoses, no compressors
- **No-Mar Tip** - Ensures undamaged trim surfaces
- **Quick-Clear Feature** - Provides easy access to nose and reduces downtime
- **Versatile** - Drives 3/4" to 2-1/2" finish nails
- **Adjustable Depth of Drive** - Provides control of nail setting depth

SKU No.	Mfg. No.
IM250II	72IM250II

Cordless Framing Nailer

- For remodeling:*
- Light Framing • Joists • Rafter • Bridging
 - Soffits • Stairs • Wall and Roof Sheathing
 - Floor Decking • Recreational Decks
- For New Construction:*
- Pick-Up and Service Work
 - Joists • Rafters • Bridging • Soffits

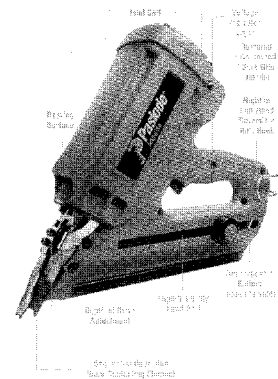

- **Fast Set-Up** - The convenience of no hoses, no compressors
- **Lightweight and Well-Balanced** - Very maneuverable. Work all day with less arm fatigue
- **Easy to Operate** - Depress tool only 3/4" to drive a nail. Fits between joists and studs
- **Reliable, State-of-the-Art Electronics** - Consistent long-life ignition. No break-in period. No "flooding." Consistent nail drive and speed.
- **Powerful Motor** - Drives 2" to 3-1/4" fasteners for every framing application. Versatile; can do a wide variety of jobs with one tool

SKU No.	Mfg. No.
IM250II	72IM250II

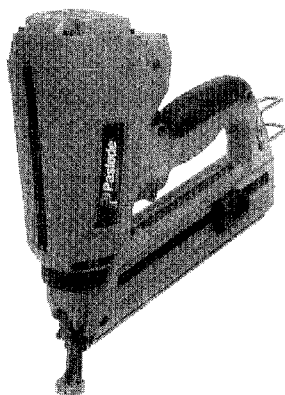

Cordless Angled Finish Nailer

- **Cordless, self-powered** - the convenience of no hoses, no compressors
- **Angled magazine** - easy access to corners - perfect for overhead use - very maneuverable - fits into tight spots
- **Light touch** - easy to operate - depress tool only 3/4" to drive a nail
- **Ni Cad rechargeable battery** - for hundreds of charges - (4,000 cycles per charge)
- **Lockout feature** - locks out tool at 10 nails to prevent firing and damage to wood surfaces

Applications:

Door Jambs / Door Stops / Base Shoe
 Baseboard Molding / Chair Rails
 Paneling / Window Casing
 Crown Molding / Cabinetry
 Pick-Up and Service Work
and much more

SKU No.	Mfg. No.
72IM325CT	IM250A

PORTABLE ELECTRIC JIGSAWS

SKIL MODEL 4235
VARIABLE SPEED

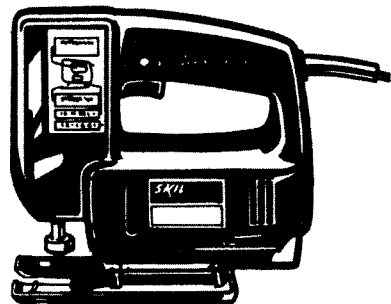

Vibration dampening rotating counterweight; accurate cutting machined plunger. Blade storage compartment in body; storage slot for blade and foot wrench. Double insulated construction. Lock-on switch, locks in both speeds. 5 foot 2 wire cord with wood cutting blade.

0-3200 strokes per minute. 5/8" stroke; cuts 2" in soft wood, 1 1/4" in hardwood, 3/8" in aluminum and 3/16" in mild steel. 120 volts AC only.

SKU NO.	Model/ Part No.	Amps.	Net wt., lbs.
724235	4235	3.0	3 5/8

PORTABLE ELECTRIC PLUNGE ROUTERS

SKIL MODEL 1823

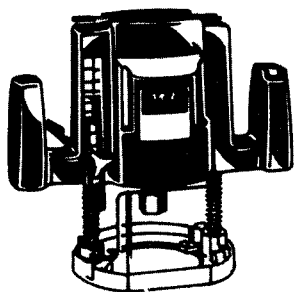

Flat top for easy bit changing, collet lock, wrench with handy storage slot. Bit storage module in handle stores 3 bits. On/off switch with indicator. Easy to read depth scale, quick adjustment and fine depth adjustment. Die cast aluminum base with non-mar base plate and chip deflector. No-load speed 25,000 RPM.

1 1/2 HP motor, 6 ft. cord. Other features as Model 1835.

SKU NO.	Model/ Part No.	HP	Amps.	Net wt., lbs.
721823	1823	1 1/2	8.5	7

SKIL POWER TOOLS

PORTABLE ELECTRIC DRILLS

SKIL PROFESSIONAL
4.0 Amp

Variable speed trigger control and rotating brush reversing switch. Trigger lock. Ball bearing construction, powerful burnout-protected motor. Professional quality chucks, double reduction gearing. Lightweight front housing with improved contour styling. Assist handle for added control. 8 foot industrial cord. Double insulated.

SKIL PROFESSIONAL

MODEL 6550 1/2" VARIABLE SPEED REVERSING



Cap. 1/2" in steel, 1" in hardwood. 0-850 RPM no load speed. 120 volts AC.

SKU NO.	Model/ Part No.	Amps.	Net wt., lbs.
726550	6550	4.0	3 3/8

JIG-SAW
3.5 AMP, VARI-ORBIT,
VARIABLE SPEED,
ADJUSTABLE, 0-3, 200 SPM

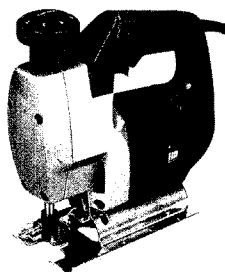

6 position adjustable orbital action - for fast cutting in a wide range of materials. Ball and roller bearing construction. Dynamic vibration reduction. Aluminum die cast gear housing. Variable speed adjusting dial in trigger. Trigger lock-on. Steel foot adjusts for reduced splinter cutting and 0-45° bevel cuts. Uses universal 1/4" shank jigsaw blades. Double insulated, 8 foot 2-wire rubber cord.

SKU NO.	Model/ Part No.	Amps.	Net wt., lbs.
724580	HD4580	3.5	5-5/8

SKIL MODEL 7313
VARIABLE SPEED

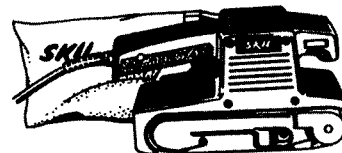

Variable speed dial, locking trigger switch. Flat top design allows bench mounting. Textured grip area. Auto-Track® automatically centers belt. Lever belt-release. Flush sanding capability. 3x18" belts, sanding area 3x5 1/8". Dust bag keeps work area clean. No-load speed 450-700 ft./min.

SKU NO.	Model/ Part No.	Amps.	Net wt., lbs.
727313	7313	4.5	5 1/4

FINISHING SANDER



Model	Product Name
Model 7275	Palm Grip Sander
Model 7276	Dustless Palm Grip Sander
1.7 Amp, 13,000 OPM	

DELTA

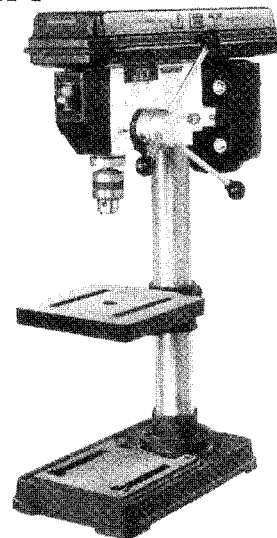

12" Drill Press
SKU 435795

3

SKIL® POWER TOOLS

PORTABLE ELECTRIC CIRCULAR SAWS
SKILSAW® PROFESSIONAL WORM DRIVE

SKIL exclusive features include high torque distributed wound field motor; precision machined worm gears. Oil pressure relief bellows prevents leaks; blade guard automatically retracts on a 45 degree cut.

All ball bearing construction; die cast aluminum motor and gear housing. Large latch type bevel and depth adjustment. Narrow width preferred by professionals. Push button blade lock. Textured grip handles.

AC-DC rated, dust resistant double pole 20 amp. switch. Heavy gauge rubber 8 foot 3 wire grounded cord.

Furnished with super sharp alloy steel combination blade and steel blade wrench.

SKILSAW® PROFESSIONAL MODEL 77 7 1/4"

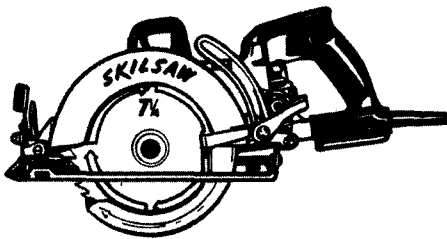

Cuts 2 3/8" at 90°, 1 1/8" at 45°. 4400 RPM no load speed. 120 volts AC-DC.

SKU NO.	Model/Part No.	Amps.	Net wt., lbs.
7277	77	13	16 3/8

SKILSAW® PROFESSIONAL MODEL 5825 6 1/2"

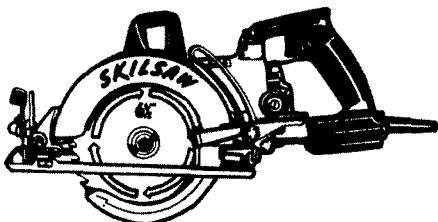

Cuts 2" at 90°, 1 3/4" at 45°. 4600 RPM no load speed. 120 volts AC-DC.

SKU NO.	Model/Part No.	Amps.	Net wt., lbs.
725825	5825	12	14 3/8

PORTABLE ELECTRIC CIRCULAR SAWS

Lateral lock off button; textured front and rear handles, blade wrench storage. Handy scale and cutting guide; sleeve bearing construction.

Die cast aluminum blade guards, zero adjust foot plate. Double insulated with two-wire cord and plug.

With super sharp hard tooth combination blade and steel blade wrench.

SKILSAW® MODEL 5150 7 1/4"

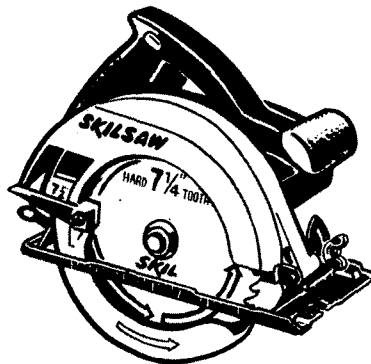

Cuts 2 1/8" at 90°, 1 1/8" at 45°. 4600 RPM no load speed, 120 volts AC.

SKU NO.	Model/Part No.	Motor HP	Amps.	Net wt., lbs.
725150	5150	2 1/8	10	9 5/8

3/8" DRILL
3.5 AMP., VARIABLE SPEED, REVERSING, 0-2250 RPM

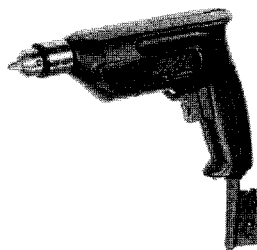

Variable speed with dial speed selector 0-2250 RPM. Forward and reverse operation for drilling and screwdriving. Precision ball and sleeve bearing construction. 1/3 hp 3.5 amp. motor. 3/8" geared chuck. Built in tool level guide. Chuck key storage. Double insulated high impact housing. Trigger lock-on. Pistol Grip design. 6 foot 2-wire cord.

SKU No.	Model/Part No.	Amps.	Net wt., lbs.
6215	718525	3.5	3.5

1/2" HAMMER DRILL VARIABLE SPEED

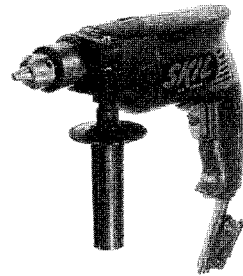

SKU No.	Model/Part No.	Amps.	Net wt., lbs.
6433	726443	4.0	4

1/2" DRILL
4.0 AMP., HIGH TORQUE, VARIABLE SPEED, REVERSING, 0-2250 RPM

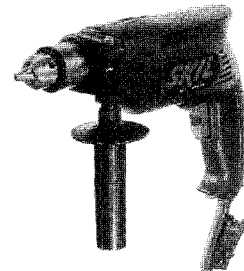





Variable speed with dial speed selector 0-800 RPM. Forward and reverse operation for drilling and screwdriving. Double reduction gearing for high torque. Ball, needle and sleeve bearing construction for lasting performance. 2/5 hp 4.0 amp. motor. 1/2" geared chuck. 360° side handle for improved handling. Built in tool level guide. Chuck key storage. Double insulated high impact housing. Trigger lock-on. Pistol grip design. 6 foot 2-wire cord.

SKU No.	Model/Part No.	Amps.	Net wt., lbs.
6355	726355	4.0	4

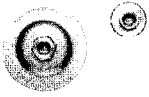
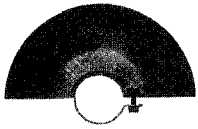
SKIL POWER TOOLS
SKIL DISC SANDER/GRINDER ACCESSORIES

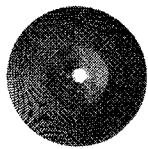
3

SKU NO.	Description	Part Number	For use on
 744200	Adapter flange Includes flange, and lock nut. Must be used with disc grinding wheels without spin-on adapter	72025	SKILL 4 1/2" grinders with M10 X 1.5 spindle, models 915, 9405, 9410
 720040	Safety guards Add when converting from a sander to a grinder.	72659	9" disc wheels
720065	Adjustable rip fence Eliminates repeated measuring and marking on rip work	25341	5625, 522 (types 6 & up) 5650, 553 (types 3 & up) 5656, 5665, 5660, 554 (types 3 & up) 856, 857, 860 5825, 367, (types 2 & 3) 77 (types 10 & 11) 5750, 5770, 5790, 807, 808, 810 5865, 825 (types 8 & 9) 866, 867, 868
 720010	Worm drive saw oil designed specifically for the SKILLSAW worm drive saw.	80111	77, 5825, 5865
 744225	7" molded rubber backing pad Highest quality rubber with a molded in threaded steel insert for mounting to a 5/8"-11 spindle.	4679	SKIL models 9645, 9745, 9845
 744217	Adjustable pad wrench Required for tightening either pad nut.	99100	parts no. 2427, 4699

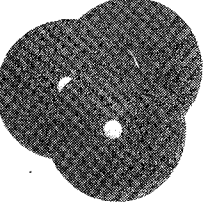
SKU NO.	Description	For Use on	Part Number	Dia. Inches	Grit	Discs Per Package
	Sanding Discs Extra long life aluminum oxide grits are phenol - resin bonded to a sturdy fiberbacking.	Metal, stone, or marble	72027	4 1/2	50	5
			72028	4 1/2	80	5
			72029	4 1/2	120	5

SKIL JIGSAW ACCESSORIES

SKU NO.	Description	Part Number
 720060	Rip fence For use on all SKIL jigsaws and cordless trimsaw and tile cutter.	94500

SKIL. DISC SANDER/GRINDER ACCESSORIES **SKIL**® POWER TOOLS

SKU NO.	Description	Part Number	Dia. Inches	Max. Speed Rating	For Use On
 744213	Rubber Backing Pad Balanced pads that provide flexibility for curves and contours can be used on SKIL sander/grinders and most other makes. Lock nut included with each pad.	72030	4½	12500 RPM	M10 x 1.5 spindle Models 914, 915, 9405, 9410
740047		99700	7	7500 RPM	Skil 7" Sander/Grinders
744221		99800	9	7000 RPM	Skil 9" Sander/Grinders
744215	Lock nut 4½" grinder. Spindle diameter M10 x 1.5 metric thread	72032		SKIL models 914, 915, 9405, 9410. Uses no. 99100 wrench	
744223	Lock nut grinders with ¾" x 11 spindles (except model 9611)	99101		SKIL models 981, 982, 983, 984, 9611, 9745, 9765, 9845, 9865. Uses no. 99100 wrench	
744219	Spindle lock wrench For 4½" grinders	72033		SKIL models 914, 915, 9405, 9410	

GRINDING WHEELS

Safety Disc Grinding Wheels

Fast cutting, reinforced grinding wheels available in aluminum oxide for grinding heavy weld beds, structural steel, steel castings, stainless steel and other ferrous metals. Silicon carbide wheels provide same superior performance on masonry, stone, concrete, cast iron.

bronze, aluminum and copper

Note: Before using disc wheels always be sure their maximum safe operating speed is not exceeded by the free speed of the tool.

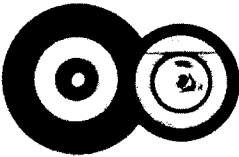
Disc Wheel Type	SKU NO.	Part Number	Diameter & Width (Inches)	Arbor Type	Grit	Max. Safe RPM
 Aluminum oxide (For metal)	744203	72023	4½ x ½	¾" rd†	30	12500

†Requires adapter flange No. 72025 or 99425

Makita

**18V 1/2" 2-SPEED
 CORDLESS
 DRIVER-DRILL**

Includes: 2 batteries, charger, Phillips/slotted bit, side grip, depth gauge, battery cover, plastic tool case.

MODEL 6343DWAE
 SKU NO. 726343DWAE

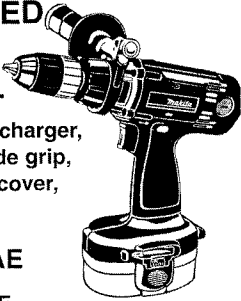

**CORDLESS/
 KEYLESS
 DRIVER-DRILL**

7.2V 2-SPEED 3/8"

Includes: 2 batteries, charger, Phillips bit, battery cover, plastic tool case.

MODEL 6019DWE
 SKU NO. 726019WE

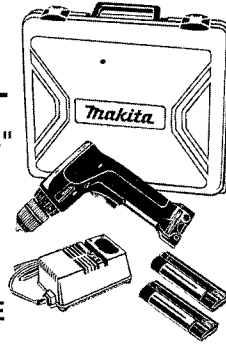

Makita

**9.6V CORDLESS
 DRIVER-DRILL KIT**

Includes: 2 batteries, Phillips slotted bit, 1 keyless chuck, battery cover, charger, plastic tool case.

MODEL 6203DWAE
 SKU NO. 726203DWAE

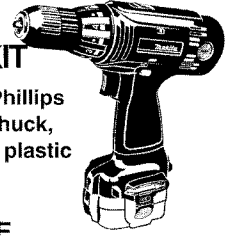

**12V 3/8" KEYLESS
 DRILL VSR 2-BIT**

Includes: 2 batteries, 1 keyless chuck, Phillips/slotted bit, battery cover, charger, plastic tool case, battery clip.

MODEL 6223DWE
 SKU NO. 726223DWE

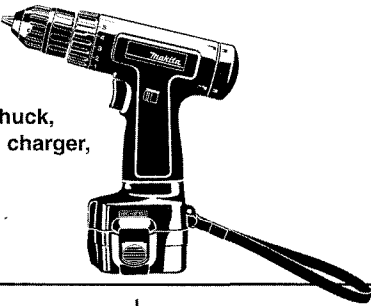

**RANDOM ORBIT SANDER
 W/DUST BAG
 HOOK AND LOOP**

Includes: 2 each abrasive discs (#60; 794518-8, #120; 794520-1, #240; 794522-7) Dust bag.

MODEL B05010

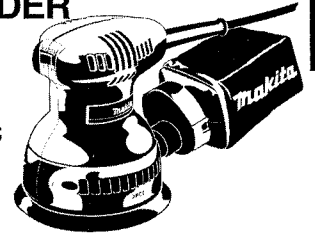

SKU NO. 72B05010

**9/16"
 HAMMER
 DRILL VSR 5 AMP**

Includes: Drill chuck, chuck key, depth gauge.

MODEL HP1500
 SKU NO. 72HP1500

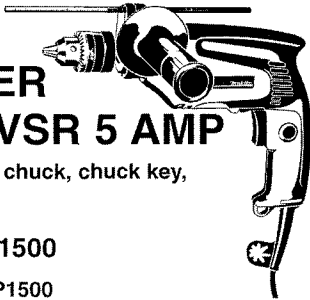

**15/16"
 ROTARY
 HAMMER SDS**

MODEL H22410
 SKU NO. 72HR2410

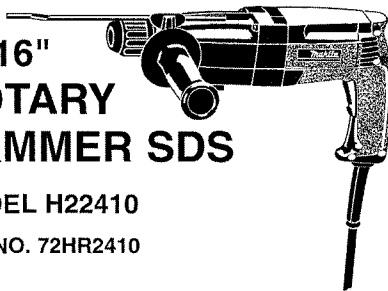

**1-9/16"
 ROTARY
 HAMMER
 (SPLINE)**

MODEL HR404C
 SKU NO. 72HR4040C



**5" ANGLE GRINDER
 6.4 AMP**

MODEL 9528NB

SKU NO. 729528NB

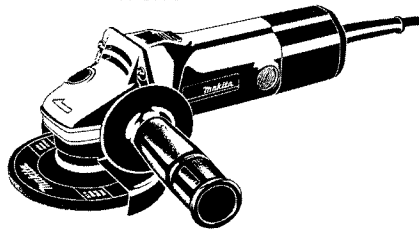

**7" ANGLE GRINDER
 15 AMP.**

MODEL GA7001L

SKU NO. 71GA7001L

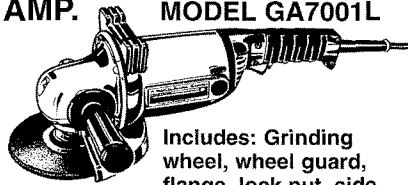

Includes: Grinding wheel, wheel guard, flange, lock nut, side handle, lock nut wrench, spindle washer.

**64 LB.
 AC/DC
 BREAKER
 HAMMER**

MODEL HM1800

• Ideal for pavement breaking, breaking up foundations, breaking through concrete slabs and asphalt cutting
 • Powerful 15 AMP motor

Includes steel tool case

SKU NO. 72HM1800

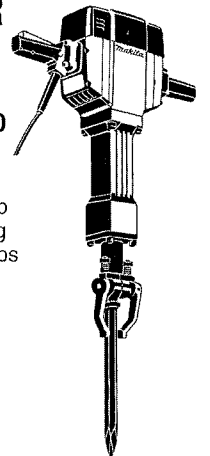

**DRYWALL REVERSIBLE
 SCREWDRIVER VSR**

**0-4000
 RPM**

MODEL 6820V

Includes: One insert bit, magnetic bit holder, nose piece.

SKU NO. 726820V

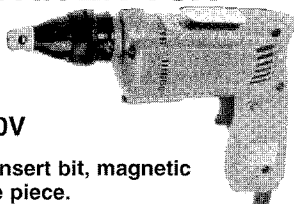

3-1/4" PLANER KIT

MODEL N1900B

Includes: Blade gauge assembly, socket wrench, guide rule, double edged carbide blade set, plastic tool case.

SKU NO. 72N1900B

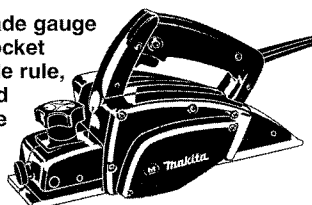

3

**CORDLESS
RECIPRO SAW KIT**
MODEL 4390DW

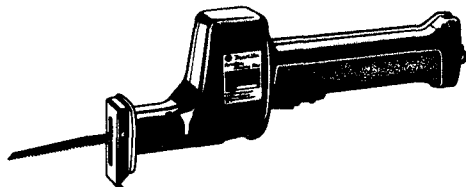

3

- part of the 9.6 volt cordless tool system
- cuts wood, mild steel and more • 2,700 SPM and 3/16" stroke length • compact and lightweight (3.1 lbs.) • cuts up to 39 feet of 1/2" soft wood from a single charge • kit includes battery and charger

SKU NO. 4390DW

SCREWDRIVERS

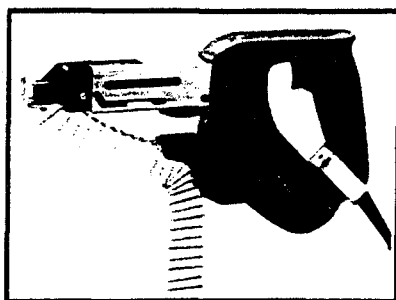

6830

**AUTOFEED SCREWDRIVER,
Variable Speed, Reversible**

- Automatically feeds screws for faster and easier one hand operation
- Adjustable stopper base can be set for 3 different screw lengths
- In-line D-handle design and variable speed for driving control • Silent clutch for reduced maintenance and quiet operation • Easy screw depth adjustment for exact depth setting • Belt clip for attaching to belt or holster

SPECIFICATIONS

Screw capacity
Dia. 5/32" x 1", 1-1/8", 1-1/4", 1-5/8"
(4 mm x 25, 28, 32, 40 mm)
No load speed 0 - 4,700 RPM
AMPS (115V) 4.3
Overall length 13-7/16"
Net weight 4.2 lbs. (1.9 kg)
Shipping weight 8.1 lbs. (3.7 kg)

STANDARD EQUIPMENT

Hex wrench (783201-2), Plastic tool case (824421-0), 3 Ea. Phillips bit (784233-2)

**AUTOFEED SCREWDRIVER
Model 6830**

SKU NO. 726830

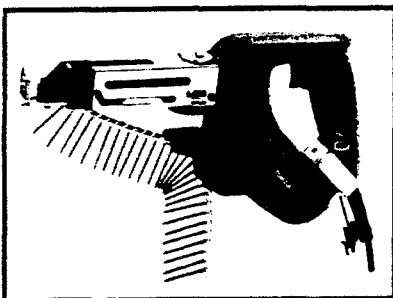

**AUTOFEED SCREWDRIVER
Model 6832**

SKU NO. 726832

Screwdriver Application

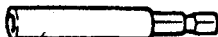

Bit holder

**Drywall Screwdriver
Application**



Self drilling screws

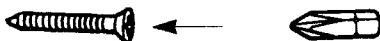

Drywall screws



Part No.	Description	Size	Qty./Box
772206-A	Screws Coarse Thread	1"	1,000
772207-A		1-1/8"	1,000
772208-A		1-1/4"	1,000
772209-A		1-5/8"	1,000
772210-A	Screws Ultra Coating	1-5/8"	1,000
772211-A		1-3/4"	1,000
772212-A		2"	800
772213-A		2-1/4"	600
772214-A	Screws Zinc	1-3/4"	1,000
772215-A		2"	800
7842332	Phillips Bit		1
1925013	Extension Handle		1

**18V COMBO
DRILL/SAW KIT
MODEL DK1016**

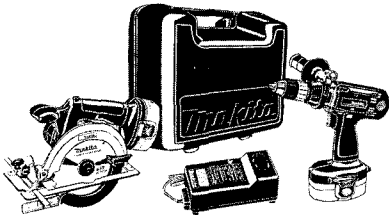

SKU NO. 72DK1016

**18V 4 PC. COMBO
DRILL/SAW/REC/LITE
MODEL DK1021RL**

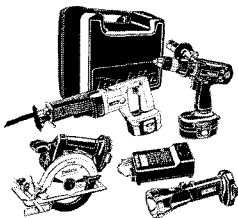

SKU NO. 72DK1021BL

**3/4" DRIVE
IMPACT WRENCH
MODEL 6906**

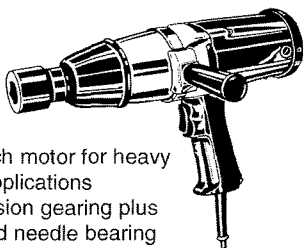

- Hi-tech motor for heavy duty applications
- Precision gearing plus ball and needle bearing construction for smooth and efficient power transmission
- Rocker type reversing switch for easy one handed forward/reverse operation
- Side handle adjusts 360° for operator convenience at any angle

SKU NO. 726906

**1/2" DRILL
VARIABLE SPEED,
REVERSIBLE
MODEL 6302H**

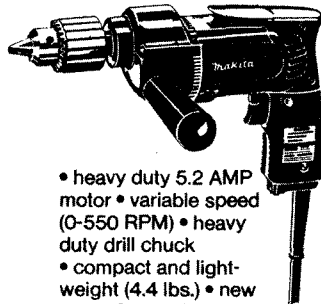

- heavy duty 5.2 AMP motor • variable speed (0-550 RPM) • heavy duty drill chuck
- compact and lightweight (4.4 lbs.) • new motor fan design for reduced noise level
- conveniently located lock-on button • side handle can be attached to either side • double insulated

SKU NO. 726302

**3/8" DRILL,
VAR. SPEED, REV.
MODEL 6405**

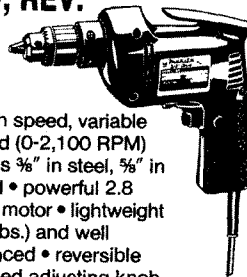

- high speed, variable speed (0-2,100 RPM)
- drills 3/8" in steel, 1/2" in wood • powerful 2.8 AMP motor • lightweight (3.1 lbs.) and well balanced
- reversible • speed adjusting knob and lock-on button • all ball bearing construction • double insulated

SKU NO. 726405

**1/2" IMPACT
WRENCH
MODEL 6905H**

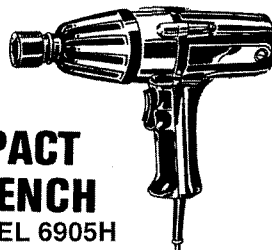

- industrial rated 4 AMP hi-tech motor
- 2000 IPM and 1700 RPM for fast tightening and loosening of bolts (3/8" - 5/8")
- lightweight (6.0 lbs.) • all ball bearing construction for long life
- convenient rocker switch • double insulated

SKU NO. 726905B

Makita
IT'S ALL THE POWER YOU NEED.®

**3/8" DRILL
MODEL 6510LVR**

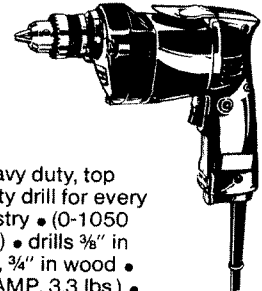

- heavy duty, top quality drill for every industry • (0-1050 RPM) • drills 3/8" in steel, 3/4" in wood • (3.0 AMP, 3.3 lbs.) • well balanced for ease of operation • double reduction gearing transmits power efficiently and effectively
- ball bearing construction for long tool life • heavy duty industrial drill chuck • double insulated

SKU NO. 726510LVR

**3/8" HAMMER
DRILL
MODEL NHP1030**



- heavy duty 4 AMP hi-tech motor • two tools in one; hammer-drilling and drill-only mode • 0-2700 RPM variable speed • all ball bearing construction for long tool life
- adjustable depth guide and side handle • double insulated

SKU NO. 72NHP1030

**3/8" ANGLE DRILL
MODEL DA3000R**



- reversing feature and compact design for getting in and out of tight spots • lightweight (3.5 lbs.) • variable speed (0-1400 RPM) • ball and needle bearing construction • motor housing grip and paddle switch • double insulated

SKU NO. 72DA3000R

3

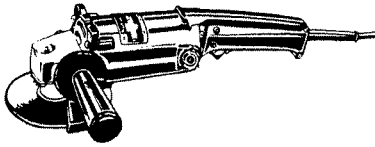
5" ANGLE GRINDER
MODEL 9005B

- one of the most powerful 5" grinders on the market
- powerful 9.4 AMP motor (10,000 RPM) in a small lightweight (6.6 lbs.) unit
- ball bearing construction for cool, smooth and efficient operation
- lock on button for continuous operation
- standard $\frac{5}{8}$ " -11 UNC spindle
- double insulated

SKU NO. 729005B

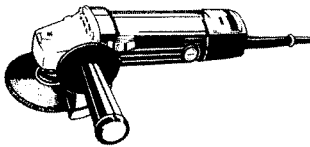
5" DISC GRINDER
MODEL 9505BHZ

- powerful 5.1 AMP motor; 10,000 RPM
- high power-to-ratio for superior performance
- double insulated
- compact and lightweight (4.6 lbs.)
- shaft lock for easy changing of accessories
- AC/DC
- conveniently located thumb switch
- standard $\frac{5}{8}$ " -11 UNC spindle

SKU NO. 729505BHZ

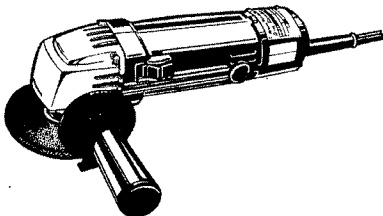
4" DISC GRINDER
MODEL N9501BZ

- 10,000 RPM for fast, efficient grinding, cutting and deburring
- high power-to-weight ratio
- compact and lightweight (4 lbs.) for less operator fatigue
- lock-on button for continuous operation
- wide assortment of optional accessories available
- double insulated

SKU NO. 72N9501BZ

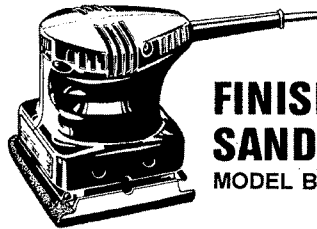
**FINISHING SANDER**
MODEL B04552

- comfortable palm grip design for easy handling and positive control
- for heavy-duty use
- 12,000 OPM
- lightweight (2.4 lbs.)
- powerful 1.8 AMP motor
- 4" square pad for flush sanding on all four sides
- double insulated

SKU NO. 72B04552

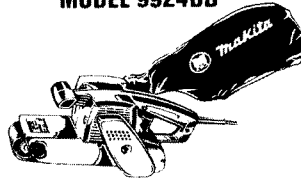
3" x 24" BELT SANDER
MODEL 9924DB

- highly efficient dust collector system
- high power-to-weight ratio (7.8 AMP, 10.5 lb.)
- belt speed of 1300 ft./min. for fast stock removal
- lever control for fast belt changes
- lock-on switch for continuous operation
- double insulated

SKU NO. 729924DB

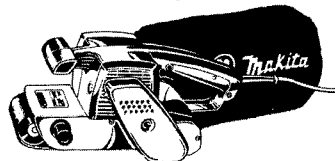
3" x 21" BELT SANDER
MODEL 9900B

- ideal for sanding a wide variety of materials
- unique design allows flush sanding
- powerful high torque motor (7.8 AMP) for fast stock removal
- belt speed of 1180 ft./min.
- lock-on switch
- efficient dust collector system for clean sanding
- double insulated

SKU NO. 729900B

Makita
IT'S ALL THE POWER YOU NEED.®**INCANDESCENT FLASHLIGHT**
MODEL ML900

- part of the 9.6VDC cordless tool system
- up to 120 minutes of continuous illumination from a single charge
- focusing switch allows either a concentrated or diffused light beam
- weighs only 1.6 lbs.
- 9.6VDC battery and charger sold separately

SKU NO. 745278

**CORDLESS DRIVER-DRILL KIT**
2-SPEED, VAR. SP., REV
MODEL 6095DWLE2

- part of the 9.6VDC cordless tool system
- equipped with double voltage (9.6V & 7.2V) one-hour fast charger
- 6-stage torque setting
- 2-speed gear selection with variable speeds; low (0-400 RPM) or high (0-1,100 RPM)
- keyless chuck system
- drills $\frac{3}{8}$ " in steel and $\frac{11}{16}$ " in wood
- electric brake
- kit includes battery, charger and tool case and above flashlight.

SKU NO. 726095DWLE2

3/8" DRILL
VSR 0-2100 RPM

- Powerful 3.3 AMP motor makes this drill suitable for many diverse applications
- Keyless chuck for convenient bit installation and removal
- High speed variable speed (0-2,100 RPM) for drilling in both wood and sheet metal
- Lightweight (3.1 lbs.) and well balanced for increased maneuverability

MODEL NO. 6406

SKU NO. 726406

JIGSAW
VARIABLE SPEED, ORBITAL

MODEL
 4304T

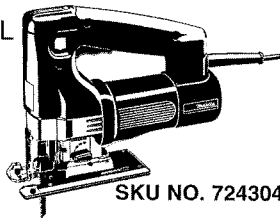

SKU NO. 724304T

- High power-to-weight ratio • 3 orbital settings plus straight cutting • 115V, 5.5 amps • Adjustable cast aluminum base; 0-45° bevel right and left • Speed dial for setting maximum speed

7 1/4" CIRCULAR SAW

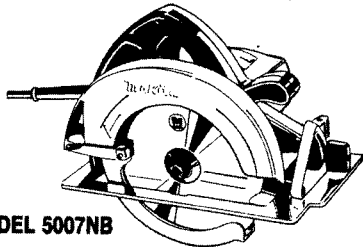

MODEL 5007NB

- 13 AMP heavy duty hi-tech motor; 5,800 RPM; AC/DC • for cross-cutting or ripping • shaft lock for easy blade replacement • heavy gauge aluminum wraparound base • well balanced for better control • complete with carbide tipped blade

SKU NO. 725007NB

10" TABLE SAW
W/ELECTRIC BRAKE
 MODEL 2703

SKU NO. 722703

- Powerful 15 amp motor for a smooth cutting
- Lightweight (40 lbs.) and portable for easy transporting to job site
- Large 27" x 22" table
- Electric brake for quick and efficient adjustments

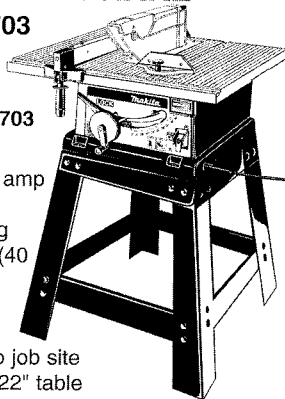

CORDLESS
CIRCULAR SAW KIT
 MODEL 5090DW

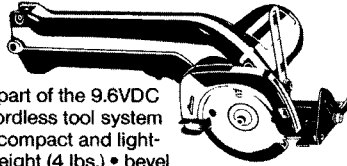

- part of the 9.6VDC cordless tool system
- compact and lightweight (4 lbs.) • bevel cuts up to 45° • adjustable cutting depth to 5/8" • cuts up to 55 ft. of 3/8" plywood from a single one hour charge
- kit includes 9.6VDC battery and charger

SKU NO. 725090DW

CORDLESS
RECIPROCAL SAW

9.6V
 MODEL
 4390DW

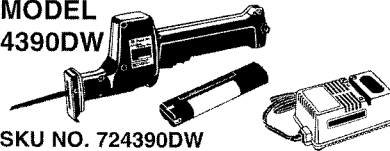

SKU NO. 724390DW

- Cuts wood, mild steel and more • 2,700 SPM and 9/16" stroke length for fast, smooth and efficient cutting
- Front grip for positive control
- Compact and lightweight (3.1 lbs.) for easy handling

Includes battery, charger, 2 blades, hex wrench.

10" MITER SAW
 MODEL LS1030

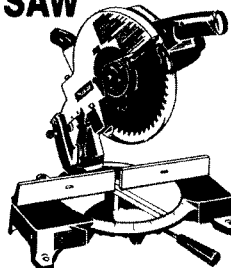

- 12 AMP motor (4,600 RPM) • cuts 4 1/8" wide at 90°; 3 1/2" wide at 45° • positive stops at 7 settings: 15°, 30°, 45° (right or left) and 0° (90° cuts) • electric brake for fast stopping of blade • lightweight (23.3 lbs.), with carrying handle for easy transporting • double insulated

SKU NO. 72LS1030

Makita
 ITS ALL THE POWER YOU NEED.®

RECIPRO SAW,
VARIABLE SPEED
 MODEL JR3000V

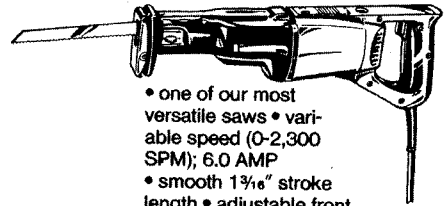

- one of our most versatile saws • variable speed (0-2,300 SPM); 6.0 AMP
- smooth 1 3/8" stroke length • adjustable front shoe assembly • ball and needle bearing construction • comes complete with steel tool case • double insulated

SKU NO. 72JR3000V

18V, 6-1/2" CORDLESS SAW
W/BRAKE 18V

Includes: Battery, Charger, carbide tipped saw blade, ripe fence, wrench, battery cover, plastic tool case.

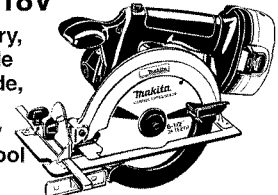

SKU NO. 725620DWA

MODEL
 5620DWA

18V 7-1/2" SLIDE
MITRE SAW W/BRAKE

MODEL
 LS7110WBEK

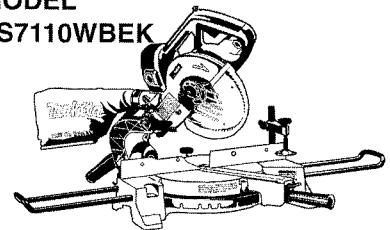

SKU NO. 72LS7110WBEK

10" DUAL COMP. SLIDE
MITRE SAW

MODEL LS1013

Includes: Carbide tipped saw blade, vertical vise, socket wrench #13, dust bag, triangular rule, 2 holders.

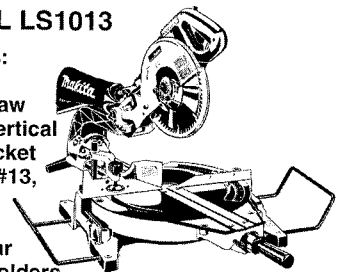

SKU NO. 72LS71013

3

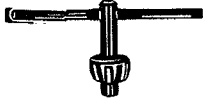

CHUCK KEY

SKU NO.	MFG. NO.	MODEL
740963	763411-7	DP4700 HP2010N
745060	763414-7	6510LVR DA3000R HP1030
745071	763415-9	DP3720
743698	763419-1	6010SDW 6012HDW
745067	763423-0	C404

CHUCK KEY HOLDER

SKU NO.	MFG. NO.
745043	411780-7

LOCK-NUT WRENCH

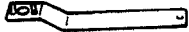

SKU NO.	MFG. NO.	FOR
745074	782401-1	4" GRINDER
745076	782413-4	5" GRINDER

SPANNER WRENCH



SKU NO.	MFG. NO.	SIZE
745073	781007-2	4" GRINDER

BATTERY CHARGERS

Rechargeable
7.2VDC Nicad Battery
Part #632002-4

SKU NO. 743704



9.6V RECHARGEABLE

MFG. NO. 632007-4

SKU NO. 743701



1 Hour fast Charger

SKU	MFG #
745025	DC1411

Automotive lighter Charger

SKU	MFG #
745028	DC1422



PHILLIPS
INSERT BIT
REDUCED NOSE

5 1/4" length

SKU NO.	MFG. NO.	TYPE
745080	784236-A	#2



RUBBER BACKING
PAD

SKU NO.	MFG. NO.	SIZE
743707	743009-6	4"
743710	743015-1	5"

INNER FLANGE

USE WITH DEPRESSED
CENTER-WHEEL, MULTI-DISC



SKU NO.	MFG. NO.	SIZE
745052	224030-9	4" Grinding Wheel
745053	224178-7	5" Grinding Wheel



ABRASIVE DISC 4" DIAM	SKU NO.	MFG. NO.	SIZE	GRIT
	740957	742038	A-5	50
	740958	742039	A-5	80
	740961	742040	A-5	120
	745070	742074	A-5	50
	745072	742075	A-5	80
	745075	742076	A-5	120

LOCKNUT



SKU NO.	MFG. NO.	DISC
745055	224501-6	4" Abrasive Wheel
740155	224503-2	4" Grinding Wheel
740157	224509-0	5" Grinding Wheel
745056	224517-1	5" Abrasive Wheel

SAND PACK



SKU NO.	MFG. NO.	SIZE	GRIT
745062	742509-3	4 1/2" x 5 1/2"	60
745064	742510-8	4 1/2" x 5 1/2"	100
745065	742511-6	4 1/2" x 5 1/2"	150



Carbide Tipped Saw Blade

Extended blade life
between resharpening.
Fast smooth cuts in a wide
range of wood and
construction materials.

CARBIDE TIPPED SAW BLADES

SKU NO.	MFG. NO.	SIZE
740180	792210-7A	10" x 5/8" x 50T
740501	792299-8	3 3/8"

COMBINATION

740498	721003-8	3 3/8"
740503	721104-2	4 3/8"

CROSS-CUT

740506	721105-0	4 3/8"
--------	----------	--------



GRINDING WHEEL
24 GRIT

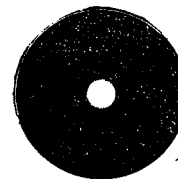

SKU NO.	MFG. NO.	SIZE
740015	741402-8	4" x 3/16"
740009	741407-8	5" x 1/4"
740006	741402-9AP	4 1/4"
		36 GRIT
740003	741405-2P	4 3/16"
		60 GRIT
740012	741438-7F	4 1/8"

TOOL HOLDER



SKU NO.	MFG. NO.	FOR
745077	823033-3A	6010SDW
740185	823033-3B	6012HDW
740190	823033-3C	FOR BATTERY

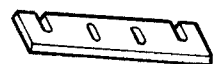

PLANER BLADE
(HIGH SPEED STEEL)

SKU NO.	MFG. NO.	SIZE	FOR
740004	731001-4	3 1/4"	1100 1900 DBW 1923B

Makita® **ROUTER BITS**

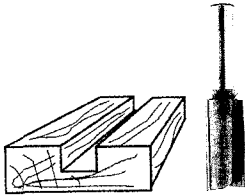

STRAIGHT 1 FLUTE BIT

SKU NO.	MFG. NO.	SHANK SIZE	DESCRIPTION
745243	733001-0A	1/4"	1/4" Carbide Tip
745250	733002-6A	1/2"	1/2" X-Long Carbide Tip
745200	733232-6A	1/4"	1/8" x 5/16" High Speed

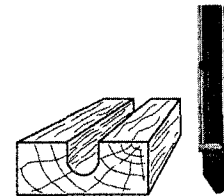

VEINING SINGLE FLUTE

SKU NO.	MFG. NO.	SHANK SIZE	DESCRIPTION
745196	733007-6A	1/4"	1/8" x 7/32" Solid Carbide
745224	733237-4A	1/4"	1/8" x 5/16" High Speed

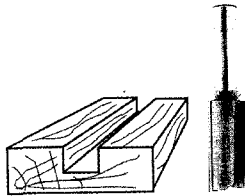

STRAIGHT 2 FLUTE BIT

SKU NO.	MFG. NO.	SHANK SIZE	DESCRIPTION
745244	733250-A	1/4"	1/16" Carbide Tip
745100	733003-1A	1/4"	1/8" x 7/16" Carbide Tip
745246	733003-2A	1/4"	3/16" Carbide Tip
745103	733003-4A	1/4"	1/4" x 3/4" Carbide Tip
745247	733003-6A	1/4"	1/4" Long Carbide Tip
745106	733003-8A	1/4"	5/16" x 1" Carbide Tip
745109	733004-0A	1/4"	3/8" x 1" Carbide Tip
745249	733004-1A	1/4"	7/16" Carbide Tip
745112	733004-2A	1/4"	1/2" x 1" Carbide Tip
745115	733004-4A	1/4"	5/8" x 3/4" Carbide Tip
745118	733004-6A	1/4"	3/4" x 3/4" Carbide Tip
745203	733233-0A	1/4"	1/4" x 7/8" High Speed
745206	733233-4A	1/4"	5/16" x 7/8" High Speed
745209	733233-8A	1/4"	3/8" x 7/8" High Speed
745212	733234-2A	1/4"	1/2" x 7/8" High Speed
745215	733234-6A	1/4"	5/8" x 5/8" High Speed
745218	733234-8A	1/4"	3/4" x 5/8" High Speed
745252	733005-4A	1/2"	3/8" Carbide Tip
745253	733252-A	1/2"	1/2" x 1" Carbide Tip
745255	733005-6A	1/2"	1/2" Carbide Tip
745256	733005-8A	1/2"	1/2" Long Carbide Tip
745258	733005-9A	1/2"	1/2" X-Long Carbide Tip
745259	733254-A	1/2"	1/2" x 2-1/2" Carbide Tip
745261	733006-4A	1/2"	3/4" Carbide Tip
745262	733006-6A	1/2"	7/8" Carbide Tip
745264	733006-8A	1/2"	1" Carbide Tip

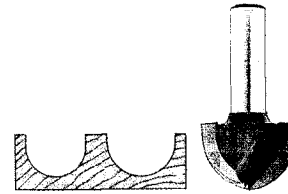

CORE BOX

SKU NO.	MFG. NO.	SHANK SIZE	DESCRIPTION
745124	733008-2A	1/4"	1/4" x 15/32" Carbide Tip
745281	733008-4A	1/4"	3/8" Carbide Tip
745193	733008-6A	1/4"	1/2" x 11/16" Carbide Tip
745282	733008-8A	1/4"	5/8" Carbide Tip
745283	733009-0A	1/4"	3/4" Carbide Tip
745284	733270-A	1/4"	1" Carbide Tip
745227	733238-2A	1/4"	1/4" x 1/4" High Speed Steel
745230	733238-6A	1/4"	1/2" x 7/16" High Speed Steel

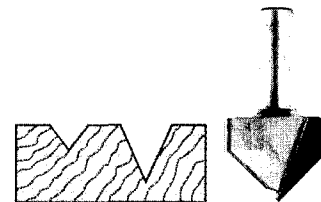

VEE GROOVEING

SKU NO.	MFG. NO.	SHANK SIZE	DESCRIPTION
745127	733009-2A	1/4"	3/8" x 1/2" Carbide Tip
745274	733009-4A	1/4"	5/8" x 3/4" Carbide Tip
745276	733009-5A	1/4"	7/8" x 7/8" Carbide Tip
745233	733239-2A	1/4"	1/2" x 5/8" High Speed

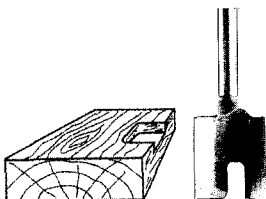

HINGE MORTISING 2 FLUTE

SKU NO.	MFG. NO.	SHANK SIZE	DESCRIPTION
745121	733006-9A	1/4"	1/2" x 1/2" Carbide Tip
745221	733235-0A	1/4"	1/2" x 1/2" High Speed

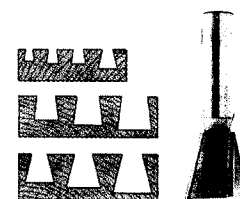

DOVETAIL

SKU NO.	MFG. NO.	SHANK SIZE	DESCRIPTION
745279	733265-A	1/2"	1/2" x 3/8" 14 Carbide Tip
745130	733009-6A	1/4"	1/2" x 1/2" 14 Carbide Tip
745236	733239-6A	1/4"	1/2" x 1/2" 14 High Speed

3

Makita® ROUTER BITS

3

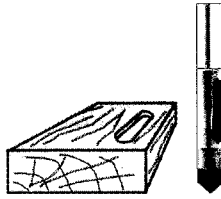

PANEL PILOT

SKU NO.	MFG. NO.	SHANK SIZE	DESCRIPTION
745133	733030-2A	1/4"	1/4"X 3/4" Carbide Tip
745273	733030-6A	1/2"	1/2"x 1-1/8" Carbide Tip
745239	733236-0A	1/4"	1/4"x 3/4" High Speed

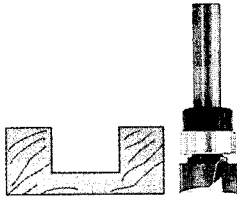

STRAIGHT 2 FLUTE

SKU NO.	MFG. NO.	SHANK SIZE	DESCRIPTION
745267	733325-A	1/4"	1/2"x 1/2" Carbide Tip
745265	733012-1A	1/4"	1/2"x 1" Carbide Tip
745268	733258-A	1/4"	5/8"x 1" Carbide Tip
745270	733259-A	1/4"	3/4"x 1" Carbide Tip
745271	733260-A	3/8"	1"x 1" Carbide Tip

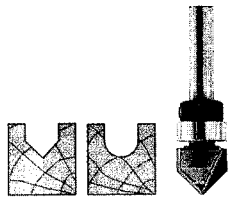

TOP BEARING ROUND NOSE & VEE GROOVE

SKU NO.	MFG. NO.	SHANK SIZE	DESCRIPTION
745285	733013-1A	1/4"	1/2"x 1/2" Round Nose Carbide Tip
745277	733014-1A	1/4"	1/2"x 1/2" Vee Groove Carbide Tip

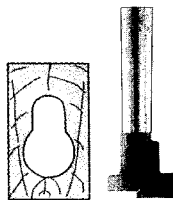

KEYHOLE SLOT

SKU NO.	MFG. NO.	SHANK SIZE	DESCRIPTION
745136	733010-1A	1/4"	3/8"x 3/8" Carbide Tip
745242	733245-1A	1/4"	3/8"x 3/8" High Speed

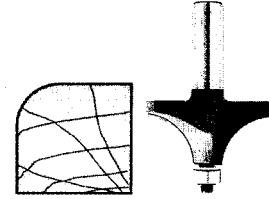

CORNER ROUNDING

SKU NO.	MFG. NO.	SHANK SIZE	DESCRIPTION
745504	733120-1A	1/4"	1/8"x 1/2" Carbide Tip Bearing Pilot
745506	733120-0A	1/4"	3/16"x 3/8" Carbide Tip Bearing Pilot
745139	733120-2A	1/4"	1/4"x 1/2" Carbide Tip Bearing Pilot
745507	733291-A	1/2"	1"x 1/2" Carbide Tip Bearing Pilot
745508	733120-4A	1/4"	5/16"x 1/2" Carbide Tip Bearing Pilot
745142	733120-6A	1/4"	3/8"x 5/8" Carbide Tip Bearing Pilot
745511	733120-8A	1/4"	1/2"x 3/4" Carbide Tip Bearing Pilot
745509	733121-0A	1/2"	3/8"x 5/8" Carbide Tip Bearing Pilot
745512	733121-2A	1/2"	1/2"x 3/4" Carbide Tip Bearing Pilot
745513	733292-A	1/2"	1-3/4"x 7/8" Carbide Tip Bearing Pilot
745514	733293-A	1/2"	3/4"x 1" Carbide Tip Bearing Pilot
745516	733329-A	1/2"	1"x 1-1/4" Carbide Tip Bearing Pilot
745245	733240-2A	1/4"	1/4"x 1/2" High Speed Solid Pilot
745248	733240-6A	1/4"	3/8"x 5/8" High Speed Solid Pilot
745251	733240-8A	1/4"	1/2"x 7/8" High Speed Solid Pilot

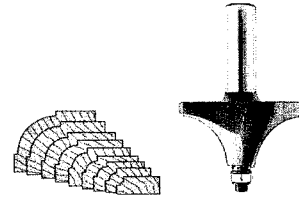

BEADING

SKU NO.	MFG. NO.	SHANK SIZE	DESCRIPTION
745522	733121-4A	1/4"	3/16"x 3/8" Carbide Tip, Bearing Pilot
745145	733121-6A	1/4"	1/4"x 1/2" Carbide Tip, Bearing Pilot
745523	733121-8A	1/4"	5/16"x 1/2" Carbide Tip, Bearing Pilot
745148	733122-0A	1/4"	3/8"x 5/8" Carbide Tip, Bearing Pilot
745525	733122-2A	1/4"	1/2"x 3/4" Carbide Tip, Bearing Pilot
745254	733241-6A	1/4"	1/4"x 1/2" High Speed, Solid Pilot
745257	733242-0A	1/4"	3/8"x 3/4" High Speed, Solid Pilot

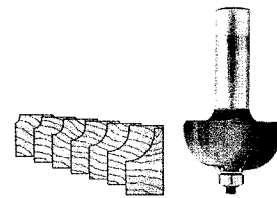

COVE

SKU NO.	MFG. NO.	SHANK SIZE	DESCRIPTION
745292	733122-6A	1/4"	1/4"x 3/8" Carbide Tip, Bearing Pilot
745151	733122-8A	1/4"	3/8"x 1/2" Carbide Tip, Bearing Pilot
745293	733123-0A	1/4"	1/2"x 5/8" Carbide Tip, Bearing Pilot
745260	733242-8A	1/4"	3/8"x 3/4" High Speed, Solid Pilot
745263	733243-0A	1/4"	1/2"x 13/16" High Speed, Solid Pilot

Makita® ROUTER BITS

3

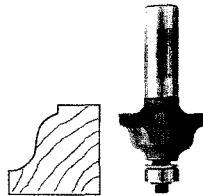

ROMAN OGEE

SKU NO.	MFG. NO.	SHANK SIZE	DESCRIPTION
745160	733123-2A	1/4"	5/23"x 5/8" Carbide Tip, Bearing Pilot
745294	733279-A	1/2"	5/32"x 5/8" Carbide Tip, Bearing Pilot
745295	733123-4A	1/4"	1/4"x 7/8" Carbide Tip, Bearing Pilot
745296	733280-A	1/2"	1/4"x 7/8" Carbide Tip, Bearing Pilot
745272	733243-2A	1/4"	5/32"x 1/2" High Speed, Solid Pilot
745275	733243-4A	1/4"	1/4"x 23/32" High Speed, Solid Pilot

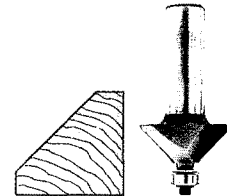

CHAMFERING

SKU NO.	MFG. NO.	SHANK SIZE	DESCRIPTION
745154	733124-4A	1/4"	1/2" 45° Carbide Tip, Bearing Pilot
745301	733285-A	1/2"	1/2" 45° Carbide Tip, Bearing Pilot
745302	733286-A	1/2"	13/16" 45° Carbide Tip, Bearing Pilot
745303	733287-A	1/4"	11/16" 15° Carbide Tip, Bearing Pilot
745503	733288-A	1/2"	15/16" 22 1/2° Carbide Tip, Bearing Pilot
745266	733244-4A	1/4"	9/16" 45° High Speed, Solid Pilot

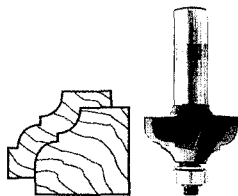

DOUBLE ROMAN OGEE 2 FLUTE

SKU NO.	MFG. NO.	SHANK SIZE	DESCRIPTION
745297	733281-A	1/4"	1/4"x 7/8" Carbide Tip, Bearing Pilot

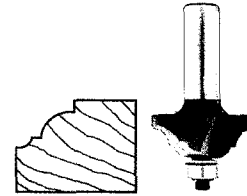

CLASSICAL

SKU NO.	MFG. NO.	SHANK SIZE	DESCRIPTION
745541	733125-0A	1/4"	3/16"x 5/16" Carbide Tip, Bearing Pilot
745543	733125-2A	1/4"	1/4"x 7/32" Carbide Tip, Bearing Pilot

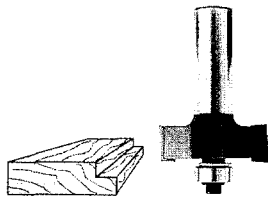

RABBETING

SKU NO.	MFG. NO.	SHANK SIZE	DESCRIPTION
745157	733124-2A	1/4"	3/8"x 1/2" Carbide Tip, Bearing Pilot
745298	733282-A	1/2"	3/8"x 1/2" Carbide Tip, Bearing Pilot
745269	733244-2A	1/4"	3/8"x 9/16" High Speed, Solid Pilot

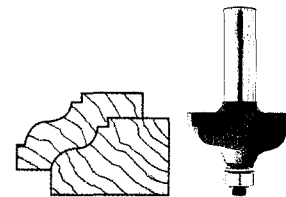

OGEE WITH FILLET

SKU NO.	MFG. NO.	SHANK SIZE	DESCRIPTION
745544	733125-4A	1/4"	5/32"x 1/2" Carbide Tip, Bearing Pilot

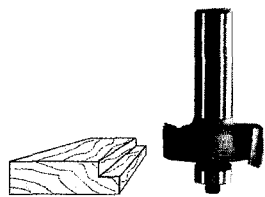

RABBETING 2 FLUTE WITH 4 BALL BEARINGS

SKU NO.	MFG. NO.	SHANK SIZE	DESCRIPTION
745299	733283-A	1/4"	1-3/8" Carbide Tip, Bearing Pilot
745300	733284-A	1/2"	1-3/8" Carbide Tip, Bearing Pilot

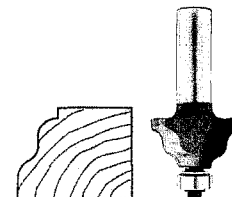

WAVY EDGE

SKU NO.	MFG. NO.	SHANK SIZE	DESCRIPTION
745552	733125-6A	1/4"	5/32"x 11/16" Carbide Tip, Bearing Pilot

Makita[®] ROUTER BITS

3

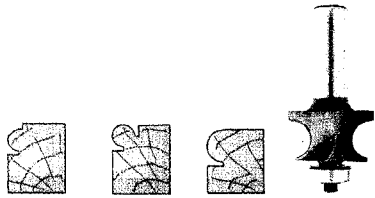

CORNER BEAD

SKU NO.	MFG. NO.	SHANK SIZE	DESCRIPTION
745550	733125-8A	1/4"	1/8"x 9/16" Carbide Tip, Bearing Pilot

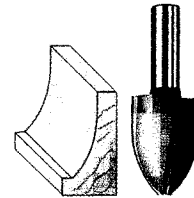

VERTICAL RAISED PANEL BIT COVE

SKU NO.	MFG. NO.	SHANK SIZE	DESCRIPTION
745555	733333-A	1/2"	1-3/16" Carbide Tip, Bearing Pilot

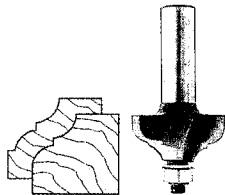

COVE AND BEAD

SKU NO.	MFG. NO.	SHANK SIZE	DESCRIPTION
745549	733126-0A	1/4"	5/32"x 11/16" Carbide Tip, Bearing Pilot

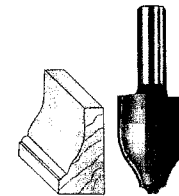

VERTICAL RAISED PANEL BIT OGEE WITH BEAD

SKU NO.	MFG. NO.	SHANK SIZE	DESCRIPTION
745556	733334-A	1/2"	1-3/16" Carbide Tip, Bearing Pilot

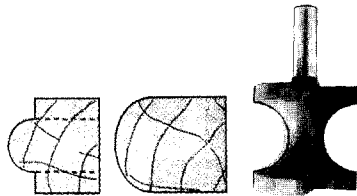

BULL NOSE BIT 2 FLUTE

SKU NO.	MFG. NO.	SHANK SIZE	DESCRIPTION
745526	733295-A	1/2"	3/8"x 3/4" Carbide Tip, Bearing Pilot

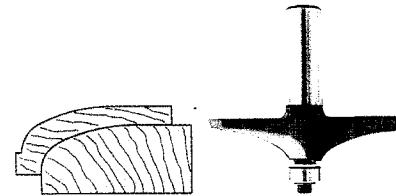

HANDRAIL/TABLE EDGE

SKU NO.	MFG. NO.	SHANK SIZE	DESCRIPTION
745517	733328-A	1/2"	1-3/4" Carbide Tip, Bearing Pilot

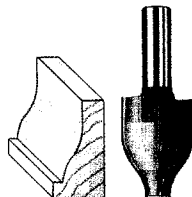

VERTICAL RAISED PANEL BITS OGEE

SKU NO.	MFG. NO.	SHANK SIZE	DESCRIPTION
745553	733332-A	1/2"	1-3/16" Carbide Tip, Bearing Pilot

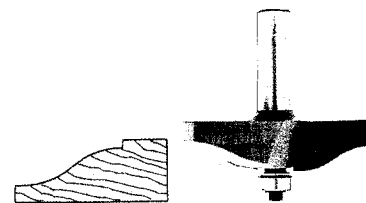

RAISED PANEL BIT OGEE 2 FLUTE

SKU NO.	MFG. NO.	SHANK SIZE	DESCRIPTION
745546	733303-A	1/2"	1-1/16" Carbide Tip, Bearing Pilot

Makita® ROUTER BITS

3

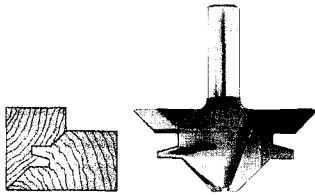

LOCK MITER

SKU NO.	MFG. NO.	SHANK SIZE	DESCRIPTION
745559	733335-A	1/2"	1-3/16" 45 Carbide Tip, Bearing Pilot

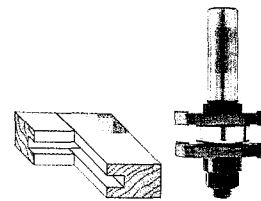

REVERSIBLE TONGUE & GROOVE ASSEMBLY 2 WING

SKU NO.	MFG. NO.	SHANK SIZE	DESCRIPTION
745561	733307-A	1/2"	1-3/4" Carbide Tip, Bearing Pilot

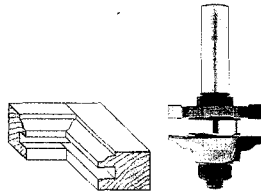

REVERSIBLE STILE & RAIL ASSEMBLY OGEE

SKU NO.	MFG. NO.	SHANK SIZE	DESCRIPTION
745558	733306-A	1/2"	1-3/4" Carbide Tip, Bearing Pilot
745564	733337-A	1/2"	2 pc Carbide Tip, Bearing Pilot

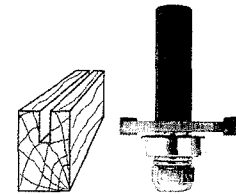

SLOTING CUTTING ASSEMBLIES - 3 FLUTE

SKU NO.	MFG. NO.	SHANK SIZE	DESCRIPTION
745529	733126-2A	1/4"	1/16" Carbide Tip
745531	733330-A	1/4"	5/64" Carbide Tip
745532	733126-3A	1/4"	3/32" Carbide Tip
745534	733126-4A	1/4"	1/8" Carbide Tip
745535	733300-A	1/4"	5/32" Carbide Tip
745537	733126-5A	1/4"	3/16" Carbide Tip
745538	733126-6A	1/4"	1/4" Carbide Tip

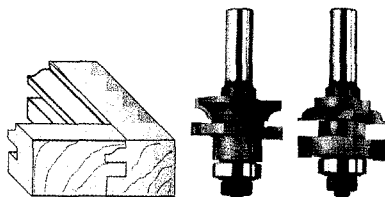

2 PC OGEE STILE AND RAIL

SKU NO.	MFG. NO.	SHANK SIZE	DESCRIPTION
745562	733336-A	1/2"	2pc Carbide Tip, Bearing Pilot

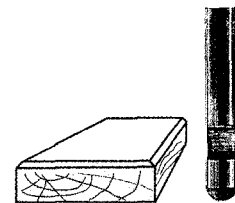

FLUSH TRIMMER - SELF-PILOTING

SKU NO.	MFG. NO.	SHANK SIZE	DESCRIPTION
745163	733128-0A	1/4"	1/4" x 1/4" Solid Carbide

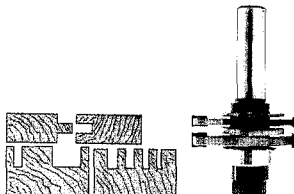

QUADRASET 2 - WING ADJUSTABLE SLOTTING

SKU NO.	MFG. NO.	SHANK SIZE	DESCRIPTION
745540	733331-A	1/2"	1-7/8" Carbide Tip, Bearing Pilot

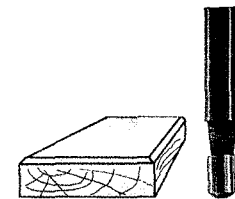

7 BEVEL TRIMMER - SELF-PILOTING

SKU NO.	MFG. NO.	SHANK SIZE	DESCRIPTION
745166	733128-2A	1/4"	1/4" 7" Solid Carbide

Makita® ROUTER BITS

3

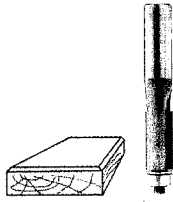

FLUSH TRIMMER 2 FLUTE

SKU NO.	MFG. NO.	SHANK SIZE	DESCRIPTION
745286	733128-1A	1/4"	1/4"x 1/2" Carbide Tip
745169	733128-7A	1/4"	3/8"x 1/2" Carbide Tip
745287	733128-8A	1/4"	3/8"x 1" Carbide Tip
745172	733128-9A	1/4"	1/2"x 1/2" Carbide Tip
745175	733129-0A	1/4"	1/2"x 1" Carbide Tip
745288	733129-1A	1/2"	1/2"x 1" Carbide Tip
745289	733274-A	1/2"	1/2"x 2" Carbide Tip

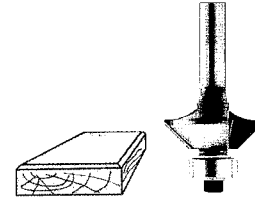

2 FLUTE BEVEL TRIMMER

SKU NO.	MFG. NO.	SHANK SIZE	DESCRIPTION
745181	733128-3A	1/4"	1/2" 15° Carbide Tip
745184	733128-4A	1/4"	1/2" 25° Carbide Tip

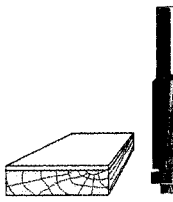

SUPERTRIM FLUSH TRIM

SKU NO.	MFG. NO.	SHANK SIZE	DESCRIPTION
745291	733326-A	1/2"	3/4" Carbide Tip

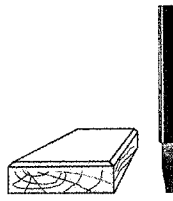

COMBINATION FLUSH /10° BEVEL TRIMMER

SKU NO.	MFG. NO.	SHANK SIZE	DESCRIPTION
745528	733128-5A	1/4"	1/4"x 3/8" Solid Carbide

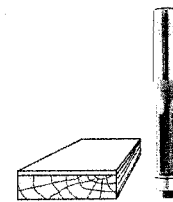

3 FLUTE FLUSH TRIMMER

SKU NO.	MFG. NO.	SHANK SIZE	DESCRIPTION
745178	733129-3A	1/4"	1/2"x 1" Carbide Tip

N80SB

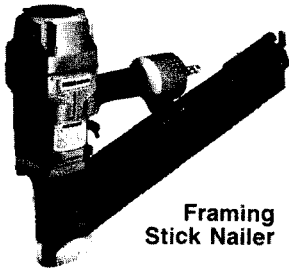

Framing Stick Nailer

Features

- Lightweight, yet rugged
- Anodized extruded aluminum magazine
- Adjustable fastener depth control
- Combination contact foot for nailing, toe-nailing
- Narrow nose for accurate fastener placement
- Comfort grip
- Anti-laddering control
- Multi-directional exhaust

Applications

- Framing
- Sheathing
- Roof decking
- Sub flooring
- Strapping
- Siding
- Fencing
- Trusses
- Exterior Decks
- Bridging

Tool Specifications

- N80SB-1 - Contact Trip
- N80SB-2 - Sequential Trip
- Fastener Range: 2" to 3-1/2" 6d to 16d
- Magazine Capacity: 75 nails
- Tool Weight: 8.4 lbs.
- Tool Height: 13-3/4"
- Tool Length: 18-3/8"
- Tool Width: 5-7/16"
- Fitting Thread Size: 1/4"NPT

SKU NO. 72N80SB-1

RN45B

Coil Roofing Nailer



Features

- Powerful
- Lightweight and well-balanced
- Replaceable anti-slip rubber frame protector
- Easy one piece - one step loading
- Increased fastener range
- Comfort grip handle
- Shingle placement guide
- Long life carbide steel contact parts
- Use on new or re-roof applications

Applications

- Asphalt shingling
- Insulation board (with Dial-A-Depth™ Fastener Control)
- Vinyl siding (with Vinyl Siding Adaptor)
- Fiber cement roofing and siding

Tool Specifications

- RN45B-1 Contact Trip
- RN45B-2 Sequential Trip
- Fastener Range: 3/4" to 1-3/4" galvanized roofing nails
- Magazine Capacity: 120 nails
- Tool Weight: 6 lbs.
- Tool Height: 10.6"
- Tool Length: 10.9"
- Tool Width: 4.6"
- Fitting Thread Size: 1/4"NPT

SKU NO. 72RN45-1

N60FN

Finish Nailer

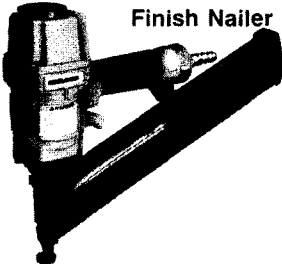

Features

- Rugged, yet lightweight design
- Dial-A-Depth™ Fastener Control
- Fast, easy rear loading
- Aluminum and stainless steel nails available
- Non-mar rubber trip foot prevents scratches
- Easy clear front nose
- Multi-directional exhaust

Applications

- Hardwood flooring
- Interior finish and trim
- Staircases
- Custom cabinets
- Tongue and groove siding
- Exterior trim
- Exterior window casings
- Paneling

Tool Specifications

- N60FN-2 - Sequential Trip
- Fastener Range: 1-1/4" to 2-1/2" 3d to 8d 15 ga.
- Magazine Capacity: 100 nails
- Tool Weight: 4.6 lbs.
- Tool Height: 10-7/8"
- Tool Length: 14-1/8"
- Tool Width: 3"
- Fitting Thread Size: 1/4"NPT

SKU NO. 72N60FN-2

MASTER MECHANIC

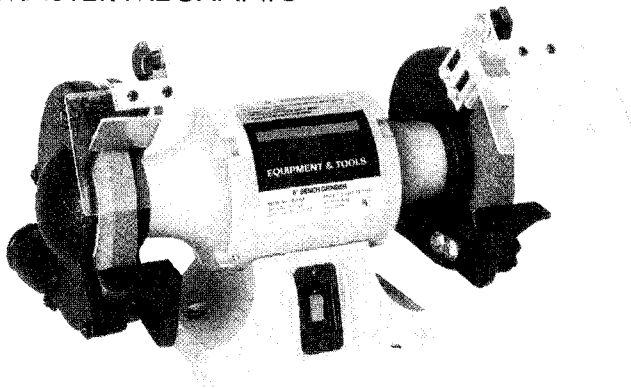

6" Dual Light Grinder
 SKU 586043

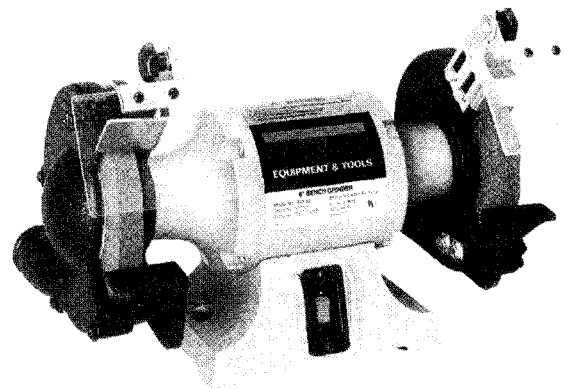

8" Dual Light Grinder
 SKU 586084

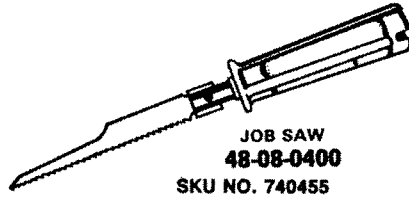

JOB SAW
 48-08-0400
 SKU NO. 740455

QUIK-LOK
 CORD SETS
 740585 8' NO. 48-76-4008
 740595 25' NO. 48-76-4026



TOOL
 HOLSTER
 NO.
 49-17-0200
 Fits belts to
 3" wide.
 SKU NO.
 700676



For
 8539-1
**SCREWDRIVER
 HOLSTER**
 NO. 49-17-0251
 SKU NO.
 740535

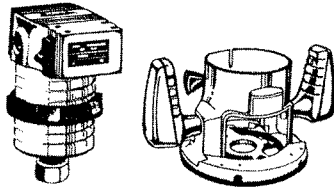

2 HP ROUTER, 12 AMP

- Heavy-Duty 2.0 Horsepower Motor
- Precision Ground Steel Collet System Secures bits, reduces vibration, ensures accurate routing.
- Fast Accurate Depth Adjustment
- Heavy-Duty Base with Large Windows Provides firm support and high visibility.
- Flat Top For resting tool and changing bits.
- Heavy-Duty 8' Rubber Cord For extended life.

MFG. NO. SKU NO.
 5682 725682

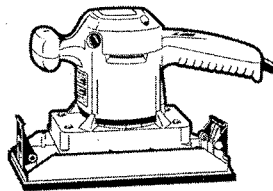

1/2 SHEET ORBITAL SANDER

- Powerful 5 Amp Motor For heavy sanding.
- 12,000 Orbits/Min. For fast removal, blemish free surfaces.
- For Continuous Production Use
- Designed For 1 Or 2 Hand Control
- Impact Resistant Reinforced Nylon Housing And Handles
- Precision Engineered For Low Vibration

MFG. NO. SKU NO.
 6010-6 726010

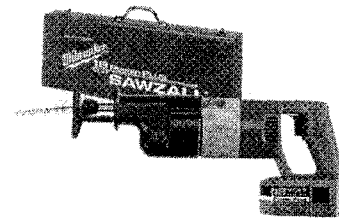

SAWZALL 18V (KIT) 2 BATT.

- Cuts Up To 60 2x4's On A Single Charge
- 18 Volt, 2.0 Amp-Hr, Power-Plus Battery Delivers more run time and is compatible with all other MILWAUKEE 18 volt products

INCLUDES TWO BATTERY PACKS, CHARGER, 2-BLADE PACK, AND STEEL CARRYING CASE.

MFG. NO. SKU NO.
 6516-22 726516-21

1/2" HAMMER DRILL VSR KIT

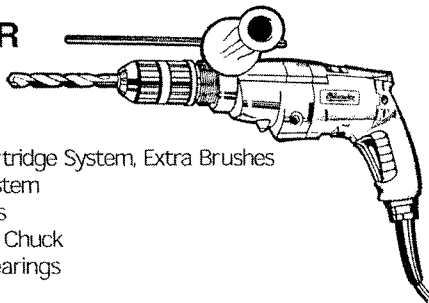

- Removable Brush Cartridge System, Extra Brushes Store in Cartridge System
- Self-Stopping Brushes
- Heavy-Duty Industrial Chuck
- All Ball and Roller Bearings
- KIT INCLUDES:
 5376-1, Keyless Chuck, Steel Carrying Case, Percussion Bits: 3/16" x 3", 1/4" x 4", 5/16" x 4", 3/8" x 4"

MFG. NO. SKU NO.
 5377-6 725377-1

3/8" HAMMER-DRILL VSR KIT

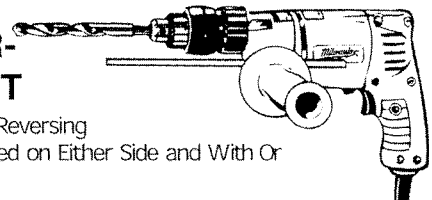

- Trigger Speed Control/Reversing
- Side Handle Can Be Used on Either Side and With Or Without Depth Gauge
- Self Stopping Brushes
- KIT INCLUDES:
 5392-2, Steel Carrying Case, Percussion Bits: 3/16" x 3", 1/4" x 4", 5/16" x 4", 3/8" x 4"

MFG. NO. SKU NO.
 5397-6 725397-1